

INSTALLATION MANUAL

AIR-TO-WATER HEAT PUMP

Please read this installation manual completely before installing the product. Installation work must be performed in accordance with the national wiring standards by authorized personnel only. Please retain this installation manual for future reference after reading it thoroughly.

THERMA V™

Original instruction



MFL68681810
Rev.23_021022

www.lg.com
Copyright © 2017 - 2022 LG Electronics Inc. All Rights Reserved.

PORTUGUÊS

ENGLISH

MAGYAR

ITALIANO

БЪЛГАРСКИ

ESPAÑOL

SRPSKI

FRANÇAIS

HRVATSKI

DEUTSCH

SLOVENŠČINA

EMHNİKA

DANSK

ČEŠTINA

NEDERLANDS

POLSKI

LIMBA ROMÂNĂ

TABLE OF CONTENTS

8 PREFACE

[Chapter 1]

9 SAFETY INSTRUCTIONS

[Chapter 2]

17 INSTALLATION PART

[Chapter 3]

20 GENERAL INFORMATION

- 20 Model Information
- 22 Related Information
- 23 Parts and Dimensions
- 34 Control Parts (For Split)
- 36 Control Parts (For Hydrosplit 1-Pipe)
- 37 Control Parts (For Hydrosplit 2-Pipe)
- 38 Control Panel
- 39 Typical Installation Example
- 44 Cycle Diagram (For R410A)
- 49 Water cycle (For R410A)

[Chapter 4]

56 INSTALLATION OF OUTDOOR UNIT

- 56 Conditions where Outdoor Unit is Installed
- 56 Drill a Hole in the Wall (For Split)
- 57 Transporting the Unit
- 59 Installation at Seaside
- 60 Seasonal wind and cautions in winter

[Chapter 5]

61 INSTALLATION OF INDOOR UNIT

- 61 Conditions where Indoor Unit is Installed
- 64 Floor area requirement : indoor unit (For R32 Split)

- 65 Ventilation requirements
- 70 Electrical Wiring

[Chapter 6]

76 PIPING AND WIRING FOR OUTDOOR UNIT

- 76 Refrigerant Piping
- 77 Preparation for Piping
- 78 Connecting Pipe to Outdoor Unit
- 78 Connecting Pipe to Indoor Unit
- 81 Finalizing
- 82 Leakage test and Evacuation
- 86 Electrical Wiring

[Chapter 7]

93 PIPING AND WIRING FOR INDOOR UNIT

- 93 Water Piping and Water Circuit Connection
- 96 Water pump Capacity
- 96 Pressure Drop
- 97 Performance curve
- 99 Frost protection by antifreeze
- 99 Water Quality
- 100 Frost protection by antifreeze valve (For Hydrosplit)
- 102 Water Volume and Expansion Vessel Pressure

[Chapter 8]

103 ACCESSORIES INSTALLATION

- 106 Before Installation
- 106 Thermostat
- 110 2nd Circuit
- 115 3rd party Backup heater (For Hydrosplit)
- 117 3rd Party Boiler
- 118 3rd Party Controller
- 119 Meter Interface
- 120 Central Controller
- 121 DHW Tank
- 125 DHW Tank Kit

4 TABLE OF CONTENTS

129	Solar Thermal Kit
131	Dry Contact
133	External Controller - Setting up programmable digital input operation
134	Remote Temperature Sensor
137	Solar pump
138	External pump
139	Wi-fi Modem
140	Smart Grid (For Split R32 Indoor unit 4 Series, For Split R410A Indoor unit 3 Series)
141	Energy State (For Split Indoor unit 5 Series, For Hydrosplit)
142	Digital Input for energy saving (ESS, Smart Grid)(For Split Indoor unit 5 Series, For Hydrosplit)
143	2Way Valve
144	3Way Valve(A)
145	3Way Valve(B)
146	Final check

[Chapter 9]

147 CONFIGURATION

147	DIP Switch Setting (For Split R32 Indoor unit 4 Series, For Split R410A Indoor unit 3 Series)
-----	---

158 SERVICE SETTING

158	How to enter service setting
158	Service setting
159	Service contact
160	Model information
161	RMC version Information
162	Open source license

163 INSTALLER SETTING

163	How to enter installer setting
164	Installer setting (For Split R32 Indoor unit 4 Series, For Split R410A Indoor unit 3 Series)
166	Overview settings
168	3 Minutes Delay
169	Select Temperature Sensor
170	Dry Contact Mode
171	Central Control Address
172	Pump test run
173	Air cooling set temp.

174	Water cooling set temp.
175	Air heating set temp.
176	Water heating set temp.
177	DHW set temp.
178	Screed drying
180	Heater on temperature
182	Water supply off temp. during cooling
184	Tank disinfection setting 1, 2
185	Tank setting 1
186	Tank setting 2
188	Heater priority
189	DHW time setting
190	TH on/off Variable, heating air
191	TH on/off Variable, heating water
192	TH on/off Variable, cooling air
193	TH on/off Variable, cooling water
194	Heating temp. setting
195	Cooling temp. setting
196	Pump setting in heating
197	Pump setting in cooling
198	LG Therma V Configuration
199	Forced operation
200	CN_CC
201	Pump frequency setting (RPM)
202	Pump Capacity
203	Smart Grid(SG)
204	Power Supply Blockage (Smart Grid)
205	Seasonal auto temp.
207	Modbus Address
208	CN_EXT
209	Anti-freezing Temperature
210	Add Zone
211	Use External Pump
212	3rd Party Boiler
213	Meter Interface
214	Pump Prerun/Overrun
215	Solar Thermal System

217	Current flow rate
218	Data logging
219	Password Initialization
220	Installer setting (For Split Indoor unit 5 Series, For Hydrosplit)
223	Select Temperature Sensor
224	Use Heating Tank Heater
225	Mixing Circuit
226	Use External Pump
226	RMC master/slave
227	LG Therma V Configuration
228	Forced operation
229	Pump Prerun/Overrun
230	Water Flow Control
231	Energy Monitoring (For Split Indoor unit 5 Series, Hydrosplit 2-Pipe)
232	Anti-Freezing Option 1 (For Split R32 Indoor unit 5 Series, For Split R410A unit 4 Series, For Hydrosplit 1-Pipe, For Hydrosplit 2-pipe)
233	Password Reset
234	Screed drying
236	Heater on temperature
238	Air heating set temp.
239	Water heating set temp.
240	Hysteresis Room Air(Heating)
241	Hysteresis Heating Water
242	Heating temp. setting
243	Pump setting in heating
244	Air cooling set temp.
245	Water cooling set temp.
246	Water supply off temp. during cooling
248	Hysteresis Room Air(Cooling)
249	Hysteresis Cooling Water
250	Cooling temp. setting
251	Pump setting in cooling
252	Seasonal auto temp.
255	Heater priority
256	DHW set temp.
257	Tank disinfection setting 1, 2
258	Tank setting 1

259	Tank setting 2
261	DHW time setting
262	Recirculation time (For Split Indoor unit 5 Series, Hydrosplit 2-Pipe)
263	Solar Thermal System
265	Pump test run
266	Frost Protection Temp.
267	Dry Contact Mode
268	Central Control Address
269	CN_CC
270	Energy state
271	Thermostat control type
272	Pump operation time
273	IDU operation time
274	Modbus Address
275	Modbus gateway memory map
278	CN_EXT
279	3rd Party Boiler
280	Meter Interface
281	Current flow rate
282	Data logging

[Chapter 10]

283 COMMISSIONING

283	Check List before Starting Operation
284	Starting Operation
285	Starting Operation flow chart
285	Airborne Noise Emission
285	Limiting concentration(For R410A)
286	Vacuum & Charge of Refrigerant
289	Trouble shooting

PREFACE

This installation manual is to present information and guide about understanding, installing, and checking **THERMAV™**.





Your careful reading before installation is highly appreciated to make no mistake and to prevent potential risks. The manual is divided into ten chapters. These chapters are classified according to installation procedure. See the table below to get summarized information.

Chapters	Contents
Chapter 1	<ul style="list-style-type: none"> Warning and Caution concerned with safety. This chapter is directly related with human safety. We strongly recommend reading this chapter carefully.
Chapter 2	<ul style="list-style-type: none"> Items Inside product Box Before starting installation, please make it sure that all parts are found inside the product box.
Chapter 3	<ul style="list-style-type: none"> Fundamental knowledge about THERMAV™. Model identification, accessories information, refrigerant and water cycle diagram, parts and dimensions, electrical wiring diagrams, etc. This chapter is important to understand THERMAV™.
Chapter 4	<ul style="list-style-type: none"> Installation about the outdoor unit. Installation location, constraints on installation site, etc
Chapter 5	<ul style="list-style-type: none"> Installation about the indoor unit. Installation location, constraints on installation site, etc Constrains when accessories are installed
Chapter 6	<ul style="list-style-type: none"> How to perform piping (for refrigerant) and wiring at the outdoor unit. Refrigerant pipe connection between the indoor unit and the outdoor unit. Electrical wiring at the outdoor unit.
Chapter 7	<ul style="list-style-type: none"> How to perform piping (for water) and wiring at the indoor unit. Water pipe connection between the indoor unit and pre-built under floor water loop pipe. Electrical wiring at the indoor unit. System set-up and configuration. As many control parameters of THERMAV™ is adjustable by control panel, deep understanding about this chapter is required to secure the operation flexibility of THERMAV™. For more detailed information, please read the separate operation manual to use control panel and adjust control parameters.
Chapter 8	<ul style="list-style-type: none"> Information about supported accessories Specification, Constraints, and wiring are described. Before purchasing accessories, please find supported specification to buy proper one.
Chapter 9	<ul style="list-style-type: none"> Test operation and check point while test running.
Chapter 10	<ul style="list-style-type: none"> Check points before starting operation are explained. Troubleshooting, maintenance, and error code list are presented to correct problems.

REMARK : ALL CONTENTS OF THIS MANUAL ARE SUBJECT TO CHANGE WITHOUT NOTICE. TO GET THE LATEST INFORMATION, PLEASE VISIT LG ELECTRONICS WEB SITE.

* The feature may be vary according to the type of model.

SAFETY INSTRUCTIONS

	Read the precautions in this manual carefully before operating the unit.		This appliance is filled with flammable refrigerant (R32)
	This symbol indicates that the Operation Manual should be read carefully.		This symbol indicates that a service personnel should be handling this equipment with reference to the Installation Manual.

The following safety guidelines are intended to prevent unforeseen risks or damage from unsafe or incorrect operation of the appliance. The guidelines are separated into 'WARNING' and 'CAUTION' as described below.

 This symbol is displayed to indicate matters and operations that can cause risk. Read the part with this symbol carefully and follow the instructions in order to avoid risk.

WARNING

This indicates that the failure to follow the instructions can cause serious injury or death.

CAUTION

This indicates that the failure to follow the instructions can cause the minor injury or damage to the product.

WARNING

Installation

- Do not use a defective or underrated circuit breaker. Use this appliance on a dedicated circuit.
 - There is risk of fire or electric shock.
- For electrical work, contact the dealer, seller, a qualified electrician, or an Authorized Service Center.
 - There is risk of fire or electric shock.

- Always ground the unit.
 - There is risk of fire or electric shock.
- Install the panel and the cover of control box securely.
 - There is risk of fire or electric shock.
- Always install a dedicated circuit and breaker.
 - Improper wiring or installation may cause fire or electric shock.
- Use the correctly rated breaker or fuse.
 - There is risk of fire or electric.
- Do not modify or extend the power cable.
 - There is risk of fire or electric shock.
- Do not install, remove, or reinstall the unit by yourself (customer).
 - There is risk of fire, electric shock, explosion, or injury
- For antifreeze, always contact the dealer or an authorized service center.
 - Almost the antifreeze is a toxic product.
- For installation, always contact the dealer or an authorized Service Center.
 - There is risk of fire, electric shock, explosion, or injury.
- Do not install the unit on a defective installation stand.
 - It may cause injury, accident, or damage to the unit.
- Be sure the installation area does not deteriorate with age.
 - If the base collapses, the unit could fall with it, causing property damage, unit failure, and personal injury.
- Do not install the water pipe system as Open loop type.
 - It may cause failure of unit.
- Use a vacuum pump or inert (nitrogen) gas when doing leakage test or purging air. Do not compress air or oxygen and do not use flammable gases.
 - There is the risk of death, injury, fire or explosion.
- Make sure the connected condition of connector in product after maintenance.
 - Otherwise, it may cause product damage.

- Do not touch leaked refrigerant directly.
 - There is risk of frostbite.
- Copper in contact with refrigerants shall be oxygen-free or deoxidized, for example Cu-DHP as specified in EN 12735-1 and EN 12735-2.
- Compliance with national gas regulations shall be observed. (for R32)
- Refrigerant tubing shall be protected or enclosed to avoid damage. (for R32)
- The installation of pipe-work shall be kept to a minimum. (for R32)
- A brazed, welded, or mechanical connection shall be made before opening the valves to permit refrigerant to flow between the refrigerating system parts. A vacuum valve shall be provided to evacuate the interconnecting pipe and/or any uncharged refrigerating system part. (for R32)
- Any person who is involved with working on or breaking into a refrigerant circuit should hold a current valid certificate from an industry-accredited assessment authority, which authorises their competence to handle refrigerants safely in accordance with an industry recognised assessment specification. (for R32)
- Do not use means to accelerate the defrosting process or to clean, other than those recommended by the manufacturer. (for R32)
- Do not pierce or burn. (for R32)
- Be aware that refrigerants may not contain an odour. (for R32)
- Dismantling the unit, treatment of the refrigerant oil and eventual parts should be done in accordance with local and national standards. (for R32)
- Flexible refrigerant connectors (such as connecting lines between the indoor and outdoor unit) that may be displaced during normal operations shall be protected against mechanical damage. (for R32)

- Pipe-work shall be protected from physical damage. (for R32)
- Mechanical connections (mechanical connectors or flared joints) shall be accessible for maintenance purposes. (for R32)

Operation

- Take care to ensure that power cable could not be pulled out or damaged during operation.
 - There is risk of fire or electric shock.
- Do not place anything on the power cable.
 - There is risk of fire or electric shock.
- Do not plug or unplug the power supply plug during operation.
 - There is risk of fire or electric shock.
- Do not touch (operate) the unit with wet hands.
 - There is risk of fire or electric shock.
- Do not place a heater or other appliances near the power cable.
 - There is risk of fire or electric shock.
- Do not allow water to run into electric parts.
 - There is risk of fire, failure of the unit, or electric shock.
- Do not store or use flammable gas or combustibles near the unit.
 - There is risk of fire or failure of unit.
- Do not use the unit in a tightly closed space for a long time.
 - It may cause damage to the unit.
- When flammable gas leaks, turn off the gas and open a window for ventilation before turning the unit on.
 - There is risk of explosion or fire.
- If strange sounds, or smell or smoke comes from unit, turn the breaker off or disconnect the power supply cable.
 - There is risk of electric shock or fire.

- Stop operation and close the window in storm or hurricane. If possible, remove the unit from the window before the hurricane arrives.
 - There is risk of property damage, failure of unit, or electric shock.
- Do not open the front cover of the unit while operation. (Do not touch the electrostatic filter, if the unit is so equipped.)
 - There is risk of physical injury, electric shock, or unit failure.
- Do not touch any electric part with wet hands. you should be power off before touching electric part.
 - There is risk of electric shock or fire.
- Do not touch refrigerant pipe and water pipe or any internal parts while the unit is operating or immediately after operation.
 - There is risk of burns or frostbite, personal injury.
- If you touch the pipe or internal parts, you should be wear protection or wait time to return to normal temperature.
 - Otherwise , it may cause burns or frostbite, personal injury.
- Turn the main power on 6 hours ago before the product starting operation.
 - Otherwise, it may cause compressor damage.
- Do not touch electric parts for 10 minutes after main power off.
 - There is risk of physical injury, electric shock.
- The inside heater of product may operate during stop mode. It is intended to protect the product.
- Be careful that some part of the control box are hot.
 - There is risk of physical injury or burns.
- When the unit is soaked (flooded or submerged), contact an Authorized Service Center.
 - There is risk of fire or electric shock.
- Be cautious that water could not be poured to the unit directly.
 - There is risk of fire, electric shock, or unit damage.

- Ventilate the unit from time to time when operating it together with a stove, etc.
 - There is risk of fire or electric shock.
- Turn the main power off when cleaning or maintaining the unit.
 - There is risk of electric shock.
- Take care to ensure that nobody could step on or fall onto the unit.
 - This could result in personal injury and unit damage.
- If the unit is not used for long time, we strongly recommend not to switch off the power supply to the unit.
 - There is risk of water freezing.
- The appliance shall be stored in a well-ventilated area where the room size corresponds to the room area as specified for operation. (for R32)
- The appliance shall be stored in a room without continuously operating open flames (for example an operating gas appliance) and ignition sources (for example an operating electric heater). (for R32)
- The appliance shall be stored so as to prevent mechanical damage from occurring. (for R32)
- Servicing shall only be performed as recommended by the equipment manufacturer. Maintenance and repair requiring the assistance of other skilled personnel shall be carried out under the supervision of the person competent in the use of flammable refrigerants. (for R32)
- When mechanical connectors are reused indoors, sealing parts shall be renewed. When flared joints are reused indoors, the flare part shall be re-fabricated. (for R32)
- Periodic(more than once/year) cleaning of the dust or salt particles stuck on the heat exchangers by using water. (for R32)
- Keep any required ventilation openings clear of obstruction. (for R32)

CAUTION

Installation

- Always check for gas (refrigerant) leakage after installation or repair of unit.
 - Low refrigerant levels may cause failure of unit.
- Keep level even when installing the unit.
 - To avoid vibration or water leakage.
- Use two or more people to lift and transport the unit.
 - Avoid personal injury.
- Do not install the unit in potentially explosive atmospheres.
- Connect the water for filling or refilling the heating system as specified by EN 1717/EN 61770 to avoid contamination of drinking water by return flow.

Operation

- Do not use the unit for special purposes, such as preserving foods, works of art, etc.
 - There is risk of damage or loss of property.
- Use a soft cloth to clean. Do not use harsh detergents, solvents, etc.
 - There is risk of fire, electric shock, or damage to the plastic parts of the unit.
- Do not step on or put anything on the unit.
 - There is risk of personal injury and failure of unit.
- Use a firm stool or ladder when cleaning or maintaining the unit.
 - Be careful and avoid personal injury.
- Do not turn on the breaker or power under condition that front panel cabinet, top cover, control box cover are removed or opened.
 - Otherwise it may cause fire, electric shock, explosion or death.

- The appliance shall be disconnected from its power source during service and when replacing parts.
- Means for disconnection must be incorporated in the fixed wiring in accordance with the wiring rules.
- The Installation kit supplied with the appliance are to be used and that old Installation kit should not be reused.
- If the supply cord is damaged, it must be replaced by the manufacturer, its service agent or similarly qualified persons in order to avoid a hazard. Installation work must be performed in accordance with the national wiring standards by authorized personnel only.
- This equipment shall be provided with a supply conductor complying with the national regulation.
- The instructions for service to be done by specialized personnel, mandated by the manufacturer or the authorized representative may be supplied in only one Community language which the specialized personnel understand.
- This appliance is not intended for use by persons (including children) with reduced physical, sensory or mental capabilities or lack of experience and knowledge, unless they have been given supervision or instruction concerning use of the appliance by a person responsible for their safety. Children should be supervised to ensure that they do not play with the appliance.



INSTALLATION PART



Thank you for choosing LG Electronics Air-to-Water Heat Pump **THERMAV**.

Before starting installation, please make it sure that all parts are found inside the product box.

(For Split)





INDOOR UNIT BOX

Item	Image	Quantity
Indoor unit		1
Installation Manual		1
Owner's / Installation manual		1

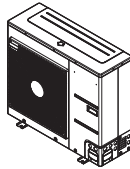
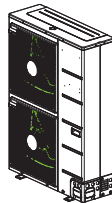

Item	Image	Quantity
Shut-off valve (For Split R32 Indoor unit 4 Series, For Split R410A Indoor unit 3 Series)		2
Installation Sheet		1

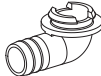
* Shut-off valve is not provided for Split 5 series, Hydrosplit.







OUTDOOR UNIT BOX

Item	Image	Quantity
Outdoor Unit U36A Chassis		1
Outdoor Unit U60A Chassis		1
Drain Cap		4
Drain Nipple		1
Damper		4

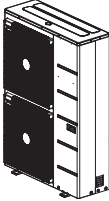









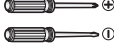



(For Hydrosplit)
INDOOR UNIT BOX

Item	Image	Quantity	Item	Image	Quantity
Indoor unit		1	Installation Sheet		1

OUTDOOR UNIT BOX

Item	Image	Quantity
Outdoor Unit U60A Chassis		1
Drain Cap		4
Drain Nipple		1
Installation Manual		1
Owner's / Installation manual		1
Strainer		1
Damper		4

INSTALLATION TOOLS

Figure	Name	Figure	Name
	Screw driver		Ohmmeter
	Electric drill		Hexagonal wrench
	Measuring tape, Knife		Ammeter
	Hole core drill		Leak detector
	Spanner		Thermometer, Horizontal meter
	Torque wrench		Flaring tool set
	Manifold Gauge		Vacuum Pump
	Pliers	-	-

GENERAL INFORMATION

With advanced inverter technology, **THERMAV™** is suitable for applications like under floor heating, under floor cooling, and hot water generation. By Interfacing to various accessories user can customize the range of the application.

In this chapter, general information of **THERMAV™** is presented to identify the installation procedure. Before beginning installation, read this chapter carefully and find helpful information on installation.

Energy Labels and Product Fiches for all possible combinations can be found at <https://www.lg.com/global/support/cedoc/cedoc>. Search for outdoor unit name in cedoc page.

Model Information

Factory Model Name

Outdoor unit

Model	No.						
	1	2	3	4	5	6	7
Split	ZH	U	W	09	6	A	0
Hydrosplit	ZH	B	W	16	8	B	0

	Signification
1	ZH : Air-to-Water-Heat Pump for R32 AH : Air-to-Water-Heat Pump for R410A
2	Classification - U : Outdoor unit of Split - B : Outdoor unit of Hydrosplit
3	Model Type - W : Inverter Heat Pump
4	Heating Capacity - e.g. 09 : 9 kW
5	Electrical ratings - 6 : 1Ø, 220-240V, 50 Hz - 8 : 3Ø, 380-415V, 50 Hz
6	Function - A : General function of Split - B : General function of Hydrosplit
7	Series number (Factory)

Indoor unit

Model	No.							
	1	2	3	4	5	6	7	8
Split	ZH	N	W	09	6	06	A	1
Hydrosplit	ZH	N	W	16	.	.	B	0

	Signification
1	ZH : Air-to-Water-Heat Pump for R32 AH : Air-to-Water-Heat Pump for R410A
2	Classification - N : Indoor unit
3	Model Type - W : Inverter Heat Pump
4	Heating Capacity - e.g. 09 : 9 kW
5	Electrical ratings - 6 : 1Ø, 220-240V, 50 Hz - 8 : 3Ø, 380-415V, 50 Hz
6	Heater Capacity - e.g. 06 : 6 kW Heater
7	Function - A : General function of Split - B : General function of Hydrosplit 1-Pipe - C : General function of Hydrosplit 2-Pipe
8	Series number (Factory)

Buyer Model Name**Outdoor unit**

Type	Refrigerant	No.								
		1	2	3	4	5	6	7	8	9
Split	R410A	H	U	16	1	.	.	.	U3	3
		H	U	16	1	M	A	.	U3	3
	R32	H	U	05	1	M	R	.	U4	4
Hydrosplit	R32	H	U	16	3	M	R	B	U3	0

Signification	
1	Air-to-Water Heat Pump
2	Classification - U : Outdoor unit
3	Heating Capacity - e.g. 16 : 16 kW
4	Electrical ratings - 1 : 1Ø, 220-240V, 50 Hz - 3 : 3Ø, 380-415V, 50 Hz
5	Leaving water combination - M : Medium Temperature
6	Refrigerant - A : R410A - R : R32
7	Function - B : General function of Hydrosplit
8	Chassis - U3 : U60A Chassis - U4 : U36A Chassis
9	Series number (Buyer) - HU*** U33 : Split R410A 3 Series - HU***MA U33 : Split R410A 4 Series - HU***MR U44 : Split R32 4 Series - HU***MRB U30 : Hydrosplit 0 Series

Indoor unit

Type	Refrigerant	No.									
		1	2	3	4	5	6	7	8	9	10
Split	R410A	H	N	16	1	6	.	.	.	NK	3
		H	N	16	1	6	M	.	.	NK	5
	R32	H	N	09	1	6	M	.	.	NK	4
		H	N	09	1	.	M	R	.	NK	5
Hydrosplit	R32	H	N	16	0	0	M	.	B	NK	0

Signification	
1	Air-to-Water Heat Pump
2	Classification - N : Indoor unit
3	Heating Capacity - e.g. 09 : 9 kW
4	Electrical ratings - 0 : For both 1Ø, 220-240V, 50 Hz and 3Ø, 380-415 V, 50 Hz - 1 : 1Ø, 220-240V, 50 Hz - 3 : 3Ø, 380-415V, 50 Hz
5	Heater capacity (kW) - 0 : Optional Accessory - 6 : 6 kW Heater - 9 : 9 kW Heater * For R32 5 Series : 6 kW Heater
6	Leaving water combination - M : Medium Temperature
7	Refrigerant - R : R32
8	Function - B : General function of Hydrosplit 1-Pipe - C : General function of Hydrosplit 2-Pipe
9	Chassis - NK : K1 Chassis
10	Series number (Buyer) - 0 : 0 Series - 1 : 1 Series

Check the model information based on the buyer model series number.
(e.g., geometry, cycle, etc.)

Related Information

Unit														
Type	Refrigerant	Heat Pump						Power Supply	Capacity		Backup Heater			
		Outdoor Unit			Indoor Unit				Heating [kW] ^{*1}	Cooling [kW] ^{*2}	Capacity [kW]	Power Supply		
		Series	Phase	Capacity [kW]	Series	Phase	Capacity [kW]							
Split	R32	0	1Ø	5	4	1Ø	9	220-240 V~50 Hz	5.5	5.5	6 (3+3)	220-240 V~50 Hz		
					5				7.0	7.0				
				7	4				9.0	9.0				
					5									
				9	4				16	16.0			13.0	
					5									
	R410A	3	1Ø	10	5	3	10	220-240 V~50 Hz	5.0	5.0	6 (3+3)	220-240 V~50 Hz		
						3			7.0	7.0				
					7	3			16	12.0			10.4	
						3								
					9	3			16	14.0			12.0	
						3								
		12	3	16	16.0	13.0								
			5											
		4	1Ø	16	16	12	3	16	220-240 V~50 Hz	12.0	10.4	6 (3+3)	220-240 V~50 Hz	
							5			14.0	12.0			
						14	3			16	16.0			13.0
							5							
	16					3	16			12.0	10.4			
						5								
	16	5	16	14.0	12.0									
		5												
	3Ø	3	3Ø	3Ø	12	3	3Ø	380-415 V~50 Hz	12.0	10.4	9 (3+3+3)	380-415 V~50 Hz		
						5			14.0	12.0	6 (2+2+2)			
14					3	16			16.0	13.0	9 (3+3+3)			
					5				6 (2+2+2)					
16					3	16			12.0	10.4	9 (3+3+3)			
					5				6 (2+2+2)					
16		5	16	14.0	12.0	9 (3+3+3)								
		5		6 (2+2+2)										
4		3Ø	16	3Ø	12	3	3Ø	380-415 V~50 Hz	12.0	10.4	9 (3+3+3)	380-415 V~50 Hz		
						5			14.0	12.0	6 (2+2+2)			
					14	3			16	16.0	13.0		9 (3+3+3)	
						5				6 (2+2+2)				
	16				3	16			12.0	10.4	9 (3+3+3)			
					5				6 (2+2+2)					
16	5	16	14.0	12.0	9 (3+3+3)									
	5		6 (2+2+2)											
Hydrosplit	R32	0	1Ø	12	0	1Ø	220-240 V~50 Hz	12.0	12.0	-	-			
								14	14.0			14.0		
				16				16.0	16.0					
								16						
			3Ø	12	3Ø	380-415 V~50 Hz	12.0	12.0						
							14	14.0	14.0					
				16			14.0	14.0						
							16	16.0	16.0					

*1 : tested under EN14511
(water temperature 30 °C → 35 °C at outdoor ambient temperature 7 °C / 6 °C)

*2 : tested under EN14511
(water temperature 23 °C → 18 °C at outdoor ambient temperature 35 °C / 24 °C)

※ All appliances were tested at atmospheric pressure.

Parts and Dimensions

Indoor unit : External

(unit : mm)

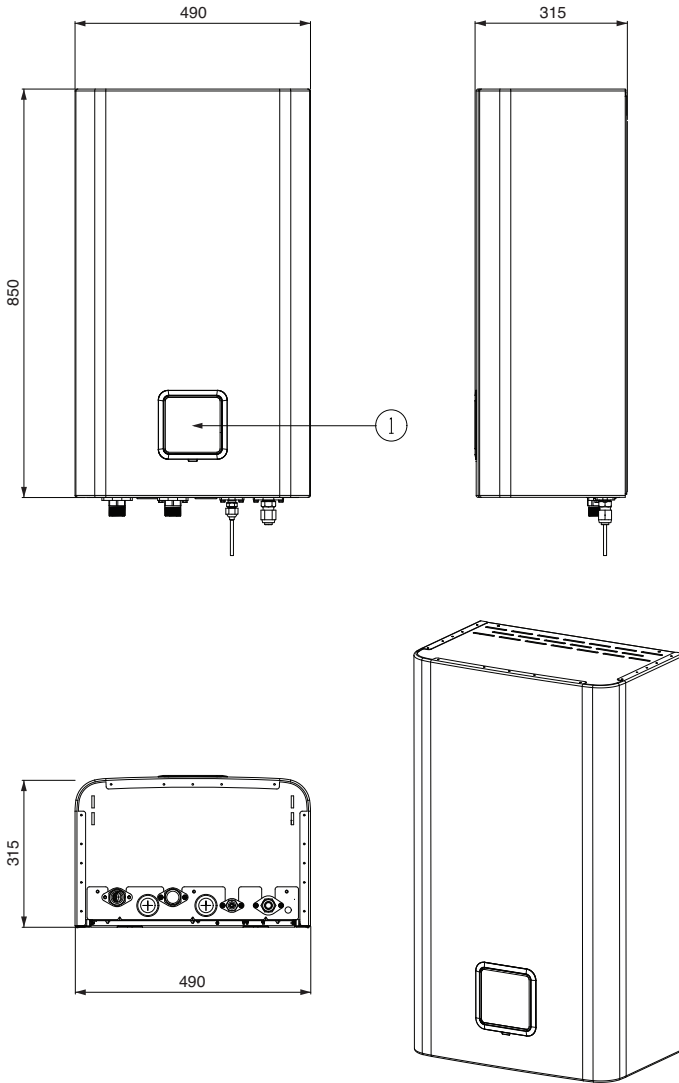

* The feature may vary according to the type of model.

Description

No	Name	Remark
1	Control Panel	Built-in Remote Controller

Indoor unit : Internal

- For Split R410A Indoor unit 3 Series

(unit : mm)

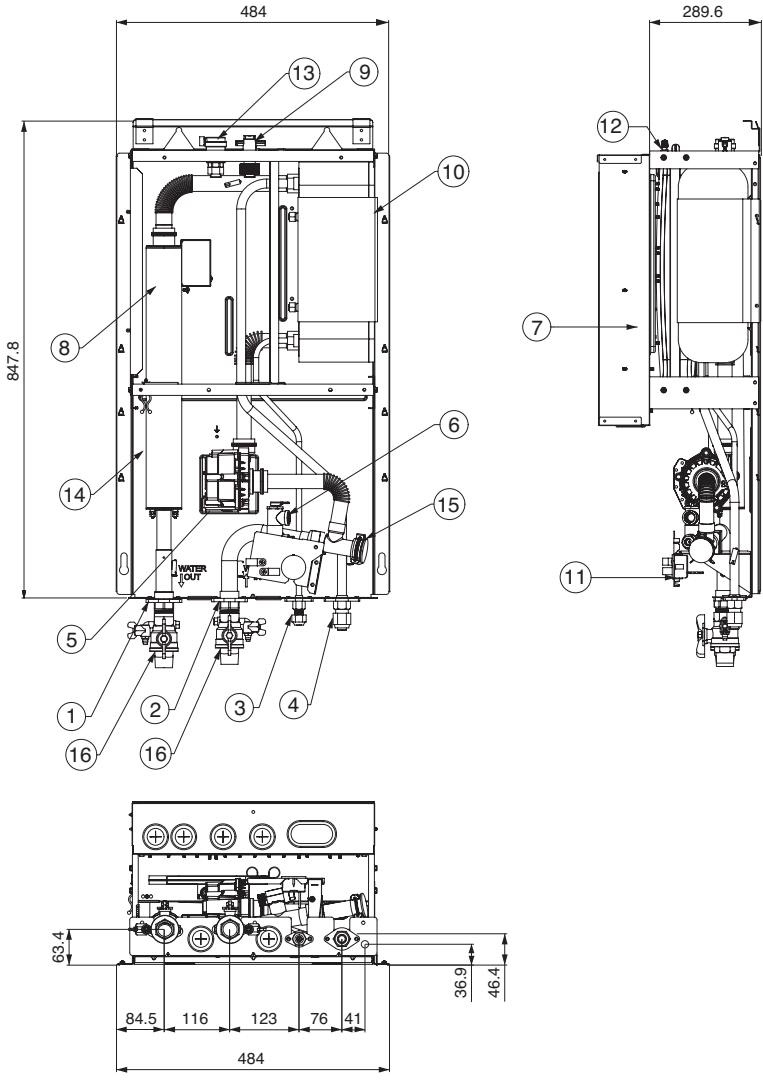

Indoor unit : Internal

- For Split R410A Indoor unit 5 Series

(unit : mm)

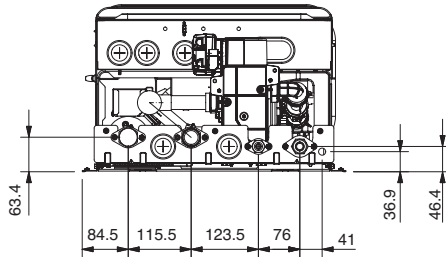
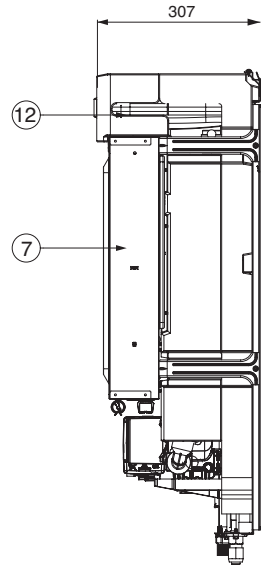
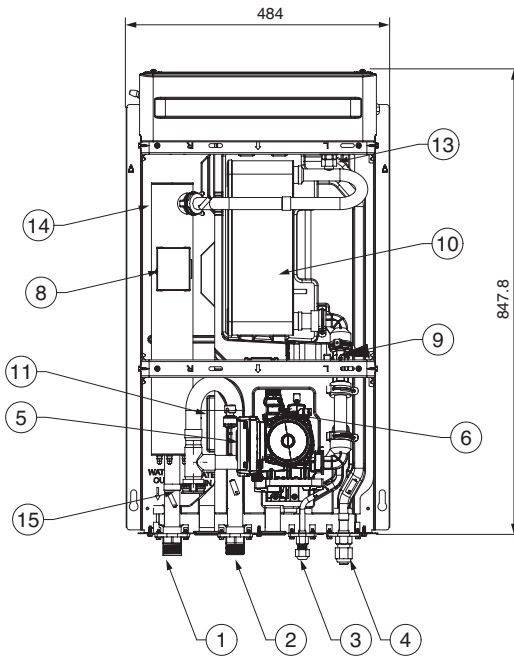

Indoor unit : Internal

- For Split R32 Indoor unit 4 Series

(unit : mm)

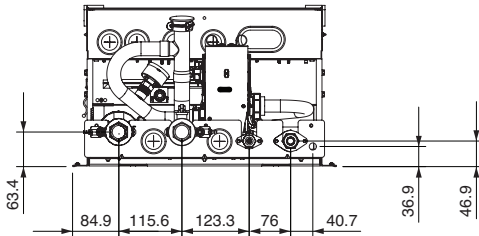
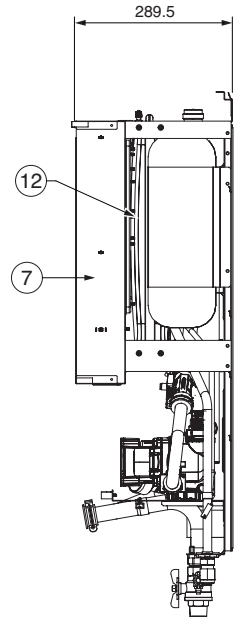
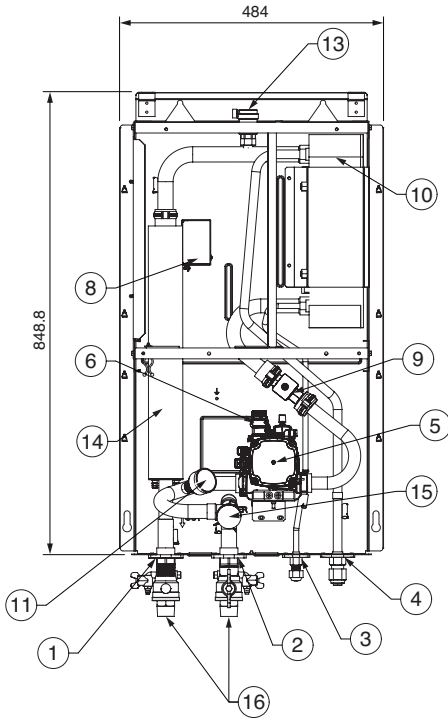

Indoor unit : Internal

- For Split R32 Indoor unit 5 Series

(unit : mm)

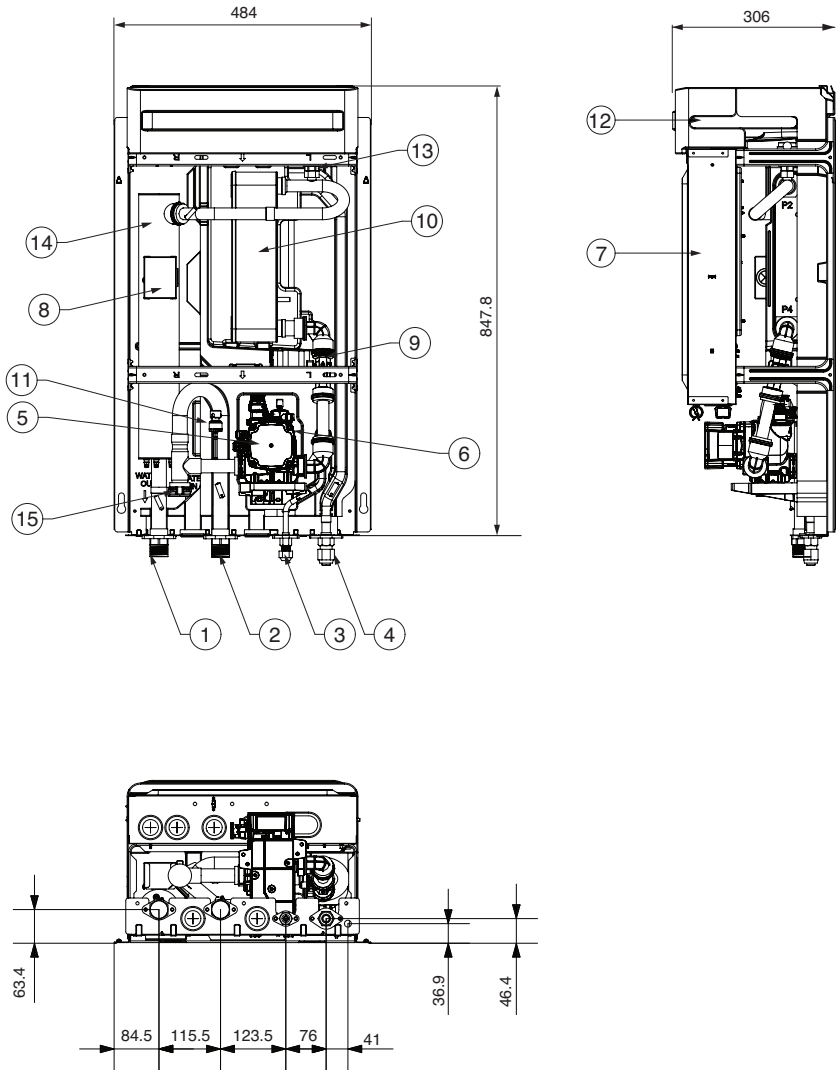

Indoor unit : Internal

- For Hydrosplit 1-pipe

(unit : mm)

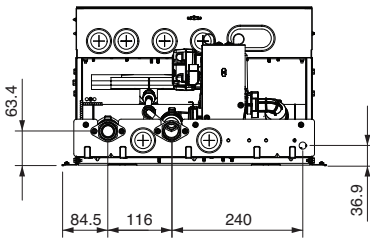
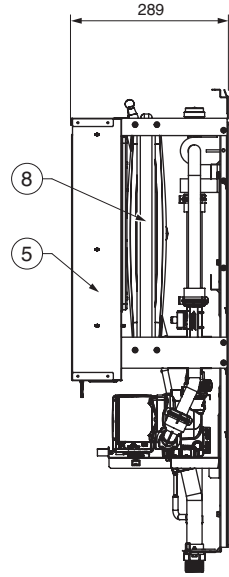
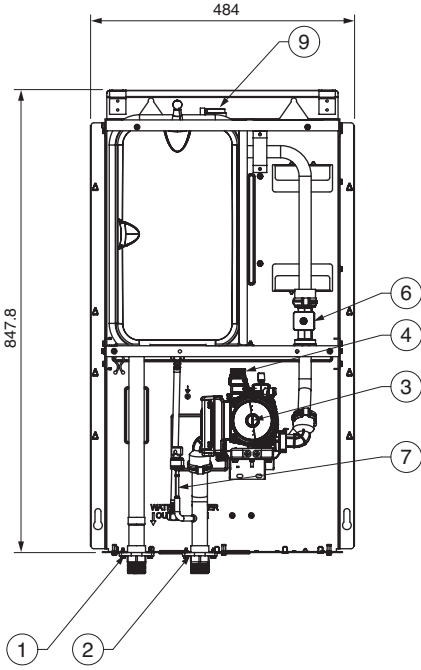

- For Hydrosplit 2-pipe

(unit : mm)

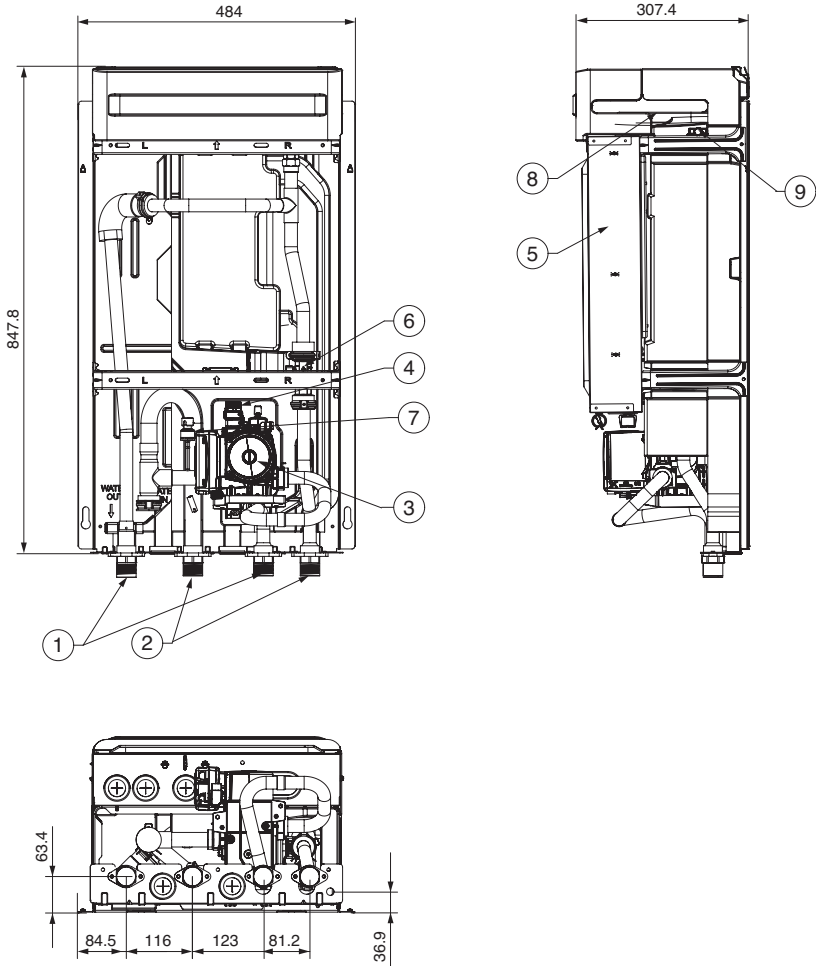

- For Split

No	Name	Remark
1	Leaving Water Pipe	Male PT 1 inch
2	Entering Water Pipe	Male PT 1 inch
3	Refrigerant Pipe	Ø 9.52 mm
4	Refrigerant Pipe	Ø 15.88 mm
5	Water Pump	Max Head 9.5 / 7 / 6 m
6	Safety Valve	Open at water pressure 3 bar
7	Control Box	PCB and terminal blocks
8	Thermal switch	Cut-off power input to backup heater at 90 °C (manual return at 55 °C)
9	Flow Switch	Minimum operation range at 15 LPM.
	Flow Sensor	Range : 5 ~ 80 L/min
10	Plate Heat Exchanger	Heat exchange between refrigerant and water
11	Pressure Gauge	Indicates circulating water pressure
	Pressure Sensor	Detects circulating water pressure
12	Expansion Tank	Absorbing Volume change of heated water
13	Air Vent	Air purging when Charging water
14	Backup heater	Cut-off power input to backup heater at 184 °C (Not Recoverable)
15	Strainer	Filtering and stacking particles inside circulating water
16	Shut-off valve	To drain or to block water when pipe connecting * For Split R32 Indoor unit 4 Series, For Split R410A Indoor unit 3 Series (Shut-off valve is not provided for Split 5 series, Hydrosplit)

- For Hydrosplit

No	Name	Remark
1	Leaving Water Pipe	Male PT 1 inch
2	Entering Water Pipe	Male PT 1 inch
3	Water Pump	Circulating the water
4	Safety Valve	Open at water pressure 3 bar
5	Control Box	PCB and terminal blocks
6	Flow Sensor	Range : 5 ~ 80 L/min
7	Pressure Sensor	Detects circulating water pressure
8	Expansion Tank	Absorbing Volume change of heated water
9	Air Vent	Air Pumping when Charging water

Outdoor unit : External

- For Split

Product Heating Capacity : 12 kW, 14 kW, 16 kW

Chassis : U60A

(unit : mm)

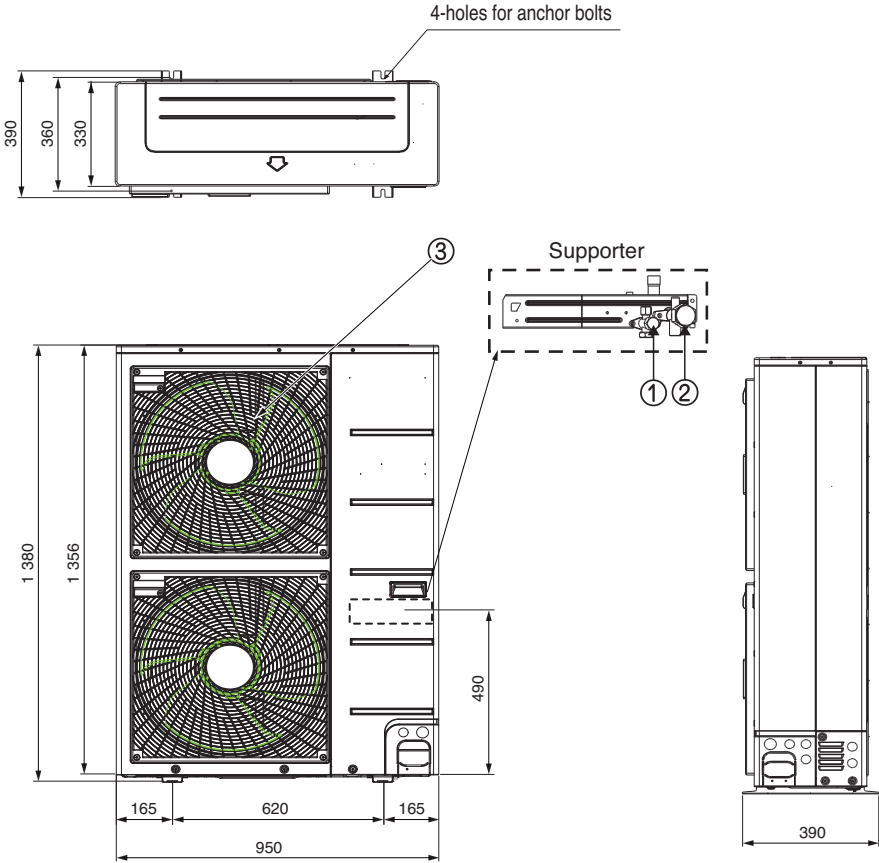

Product Heating Capacity : 5 kW, 7 kW, 9 kW
Chassis : U36A

(unit : mm)

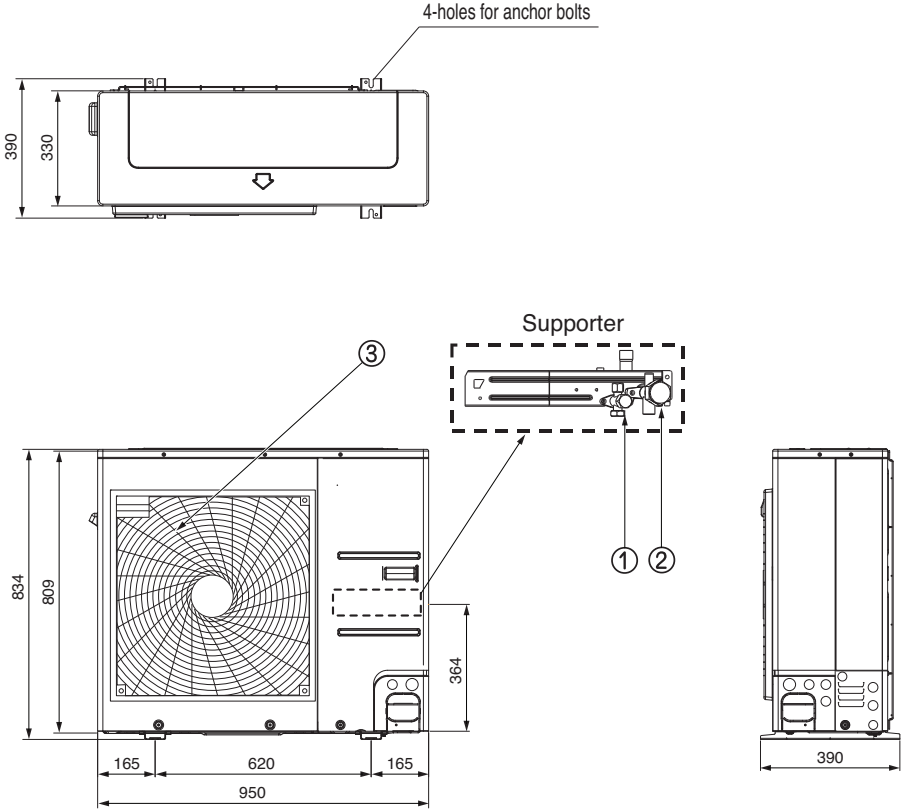

Outdoor unit : External

- For Hydrosplit

Product Heating Capacity : 12 kW, 14 kW, 16 kW

Chassis : U60A

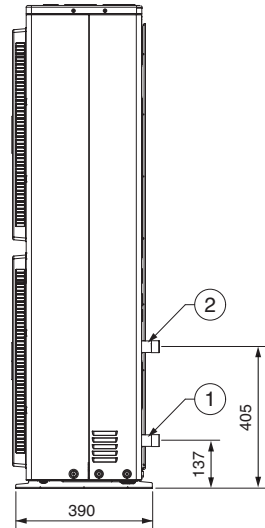
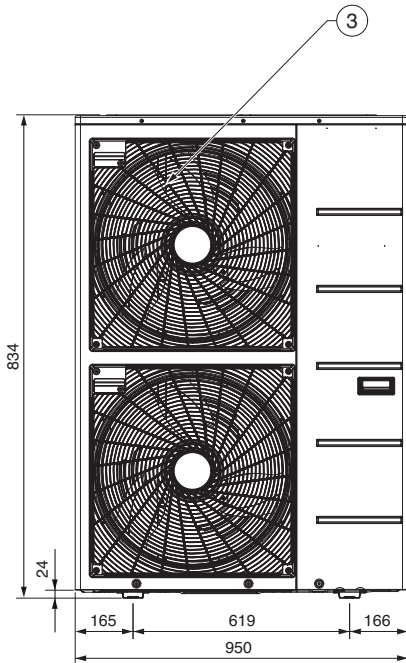
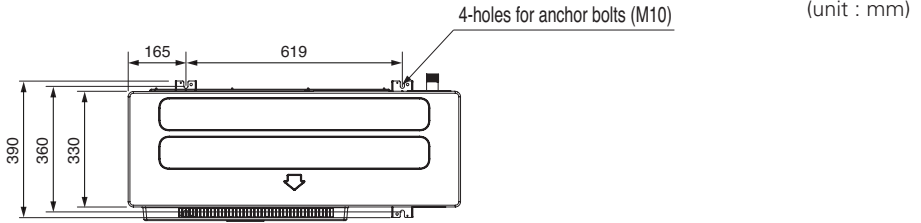

Description

No	Name
1	Entering Water Pipe
2	Leaving Water Pipe
3	Air discharge Grille

Control Parts (For Split)

Control Box : Indoor Unit

1Ø Electric Heater Model

(For R32 Indoor unit 4 Series, For R410A Indoor unit 3 Series)

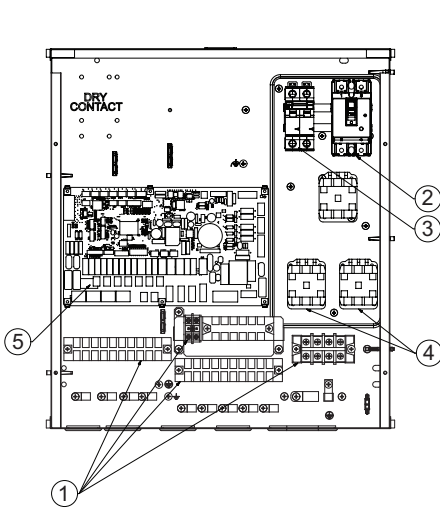

With magnet switch
(Production date : Until Sep. 30, 2019)

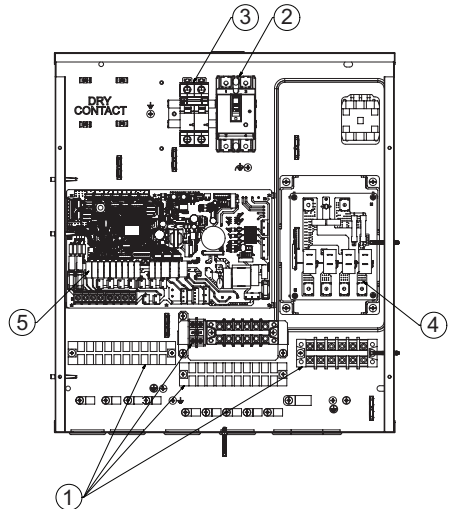

With heater PCB
(Production date : From Oct. 1, 2019)

Description

No	Name	Remark
1	Terminal blocks	The terminal blocks allow easy connection of field wiring
2	Unit ELB	The ELB protects the unit against overload or short circuit
3	Booster heater ELB (optional)	The ELB protects the booster heater in DHW tank against overload or short circuit
4	Magnet switch Heater PCB (Relay)	Magnet switch / Heater PCB(Printed Circuit Board) controls the functioning of the backup heater
5	Main PCB	The main PCB(Printed Circuit Board) controls the functioning of the unit

1Ø Electric Heater Model
 (For R32 Indoor unit 5 Series,
 For R410A Indoor unit 5 Series)

3Ø Electric Heater Model
 (For R410A Indoor unit 5 Series)

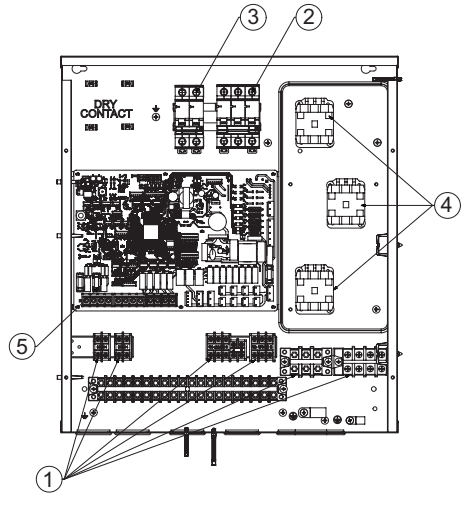
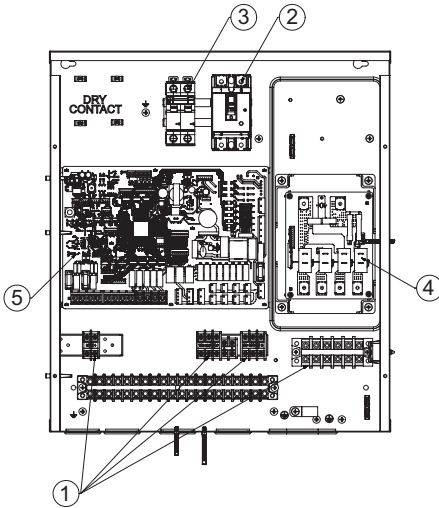

Description

No	Name	Remark
1	Terminal blocks	The terminal blocks allow easy connection of field wiring
2	Unit ELB	The ELB protects the unit against overload or short circuit
3	Booster heater ELB (optional)	The ELB protects the booster heater in DHW tank against overload or short circuit.
4	Heater PCB (Relay)	Heater PCB(Printed Circuit Board) controls the functioning of the backup heater
5	Main PCB	The main PCB(Printed Circuit Board) controls the functioning of the unit

Control Parts (For Hydrosplit 1-Pipe)

Control Box : Indoor Unit

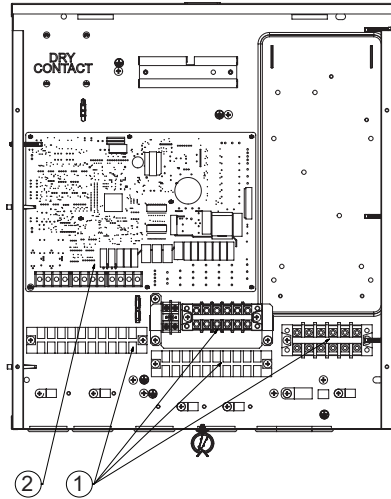

Description

No	Name	Remark
1	Terminal blocks	The terminal blocks allow easy connection of field wiring
2	Main PCB	The Main PCB(Printed Circuit Board) controls the functioning of the unit

Control Parts (For Hydrosplit 2-Pipe)

Control Box : Indoor Unit

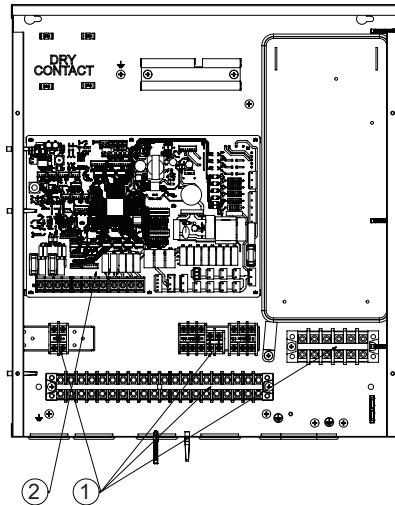

Description

No	Name	Remark
1	Terminal blocks	The terminal blocks allow easy connection of field wiring
2	Main PCB	The Main PCB(Printed Circuit Board) controls the functioning of the unit

Control Panel

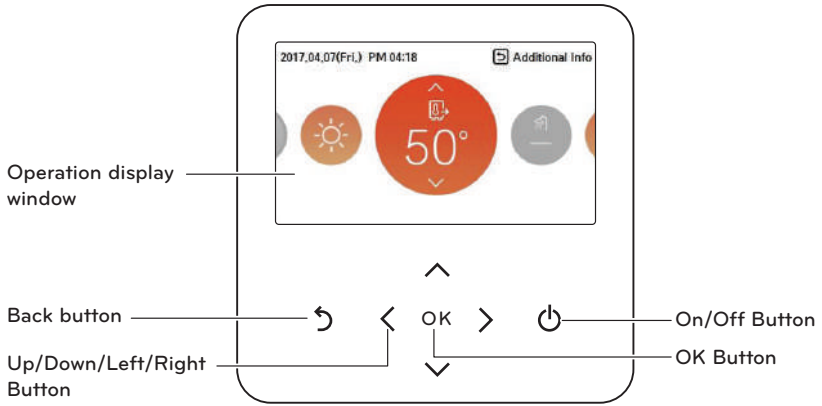

Operation display window	Operation and Settings status display
Back button	When you move to the previous stage from the menu's setting stage
Up/down/left/right button	When you change the menu's setting value
OK button	When you save the menu's setting value
On/Off button	When you turn ON/OFF the AWHP

Typical Installation Example

CAUTION

If **THERMAV** is installed with pre-existing boiler, the boiler and **THERMAV** should not be operated together. If entering water temperature of **THERMAV** is above 55 °C, the system will stop operation to prevent mechanical damage of the product. For detailed electric wiring and water piping, please contact authorized installer.

Some installation scenes are presented for example. As these scenes are conceptual figures, installer should optimize the installation scene according to the installation conditions. Note that buffer tank should be installed.

CASE 1: Connecting Heat Emitters for Heating and Cooling

(Under floor loop, Fan Coil Unit, and Radiator)

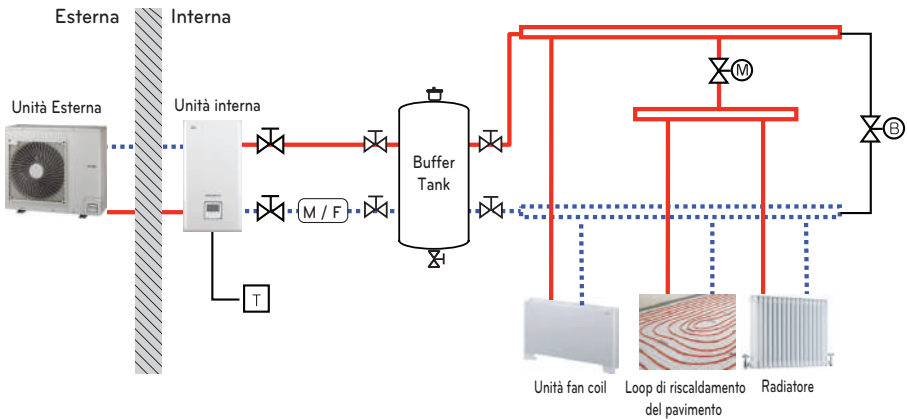

NOTE

- Room thermostat
 - Type of thermostat and specification should be complied with chapter 8 of **THERMAV** installation manual.
- 2way valve
 - It is important to install 2way valve to prevent dew condensation on the floor and radiator while cooling mode.
 - Type of 2way control valve and specification should be complied with chapter 8 of **THERMAV** installation manual.
 - 2way valve should be installed at the supply side of the collector.
- By-pass valve
 - To secure enough water flow rate, by-pass valve should be installed at the collector.
 - By-pass valve should guarantee minimum water flow rate in any case. Minimum water flow rate is described in water pump characteristics curve.

— High Temperature

.... Low Temperature

(M / F) Magnetic Filter (Mandatory)



Room Thermostat(Field supply)



2way valve (Field supply)



Shut-off valve



By-pass valve
(Field supply)

CASE 2: Connecting DHW Tank

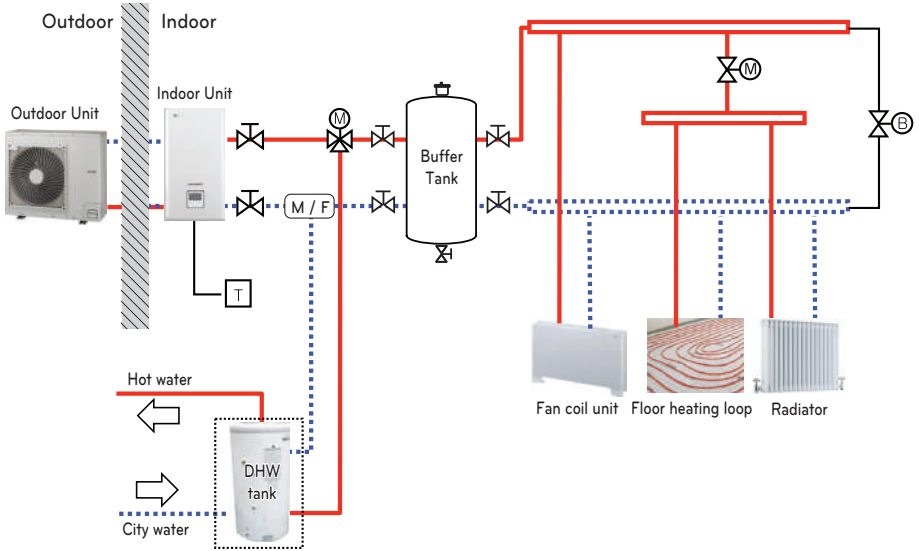

NOTE

- DHW tank
 - It should be equipped with booster heater to generate sufficient heat energy in very cold season.
 - DHW : Domestic Hot Water
- 3way valve
 - Type of 3way valve and specification should be complied with chapter 8 of **THERMA V** installation manual.

High Temperature	Room Thermostat(Field supply)
Low Temperature	2way valve (Field supply)
Shut-off valve	3way valve (Field supply)
Magnetic Filter (Mandatory)	By-pass valve(Field supply)

CASE 3: Connecting Solar thermal system

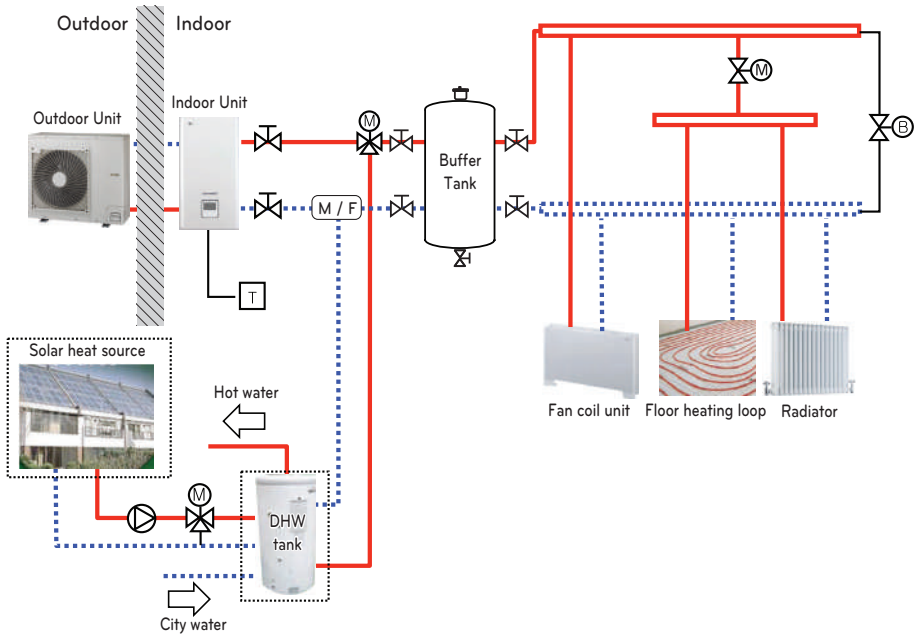

NOTE

- DHW tank
 - It should be equipped with booster heater to generate sufficient heat energy in very cold season.
 - DHW : Domestic Hot Water
- Pump
 - Maximum power consumption of pump should be less than 0.25 kW.

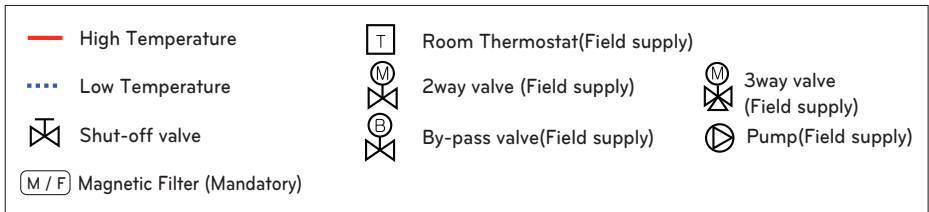

CASE 4-1: Connecting 2nd Circuit

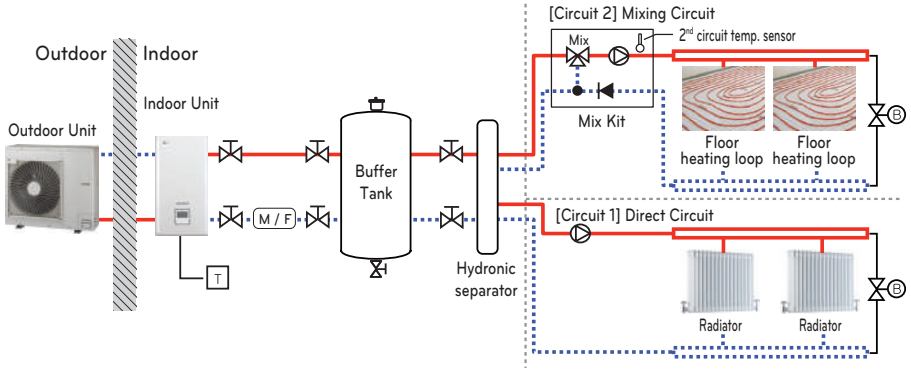

CASE 4-2: Connecting 2nd Circuit (For Hydrosplit)

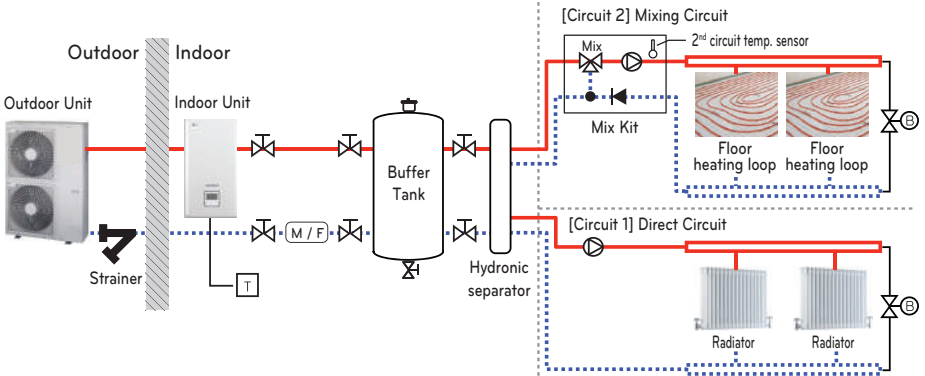

* Water In / Water Out installation scene may vary depending on the model.

NOTE

- Mix Kit
 - You can install it when you want to set the temperature of two rooms individually
 - When heating, Circuit 2 can not be higher than Circuit 1.
 - When cooling, Circuit 2 can not be lower than Circuit 1.
 - The types and specifications of the Mix Kit are to comply with chapter 8 of the **THERMAV** Installation Manual.

High Temperature	Room Thermostat(Field supply)	3way valve (Field supply)
Low Temperature	2way valve (Field supply)	Pump(Field supply)
Shut-off valve	By-pass valve(Field supply)	Mix Kit (Field supply)
Magnetic Filter (Mandatory)	Air vent (Field supply)	
Pressure Regulation valve (Field supply)		

CASE 5: Connecting 3rd Party Boiler

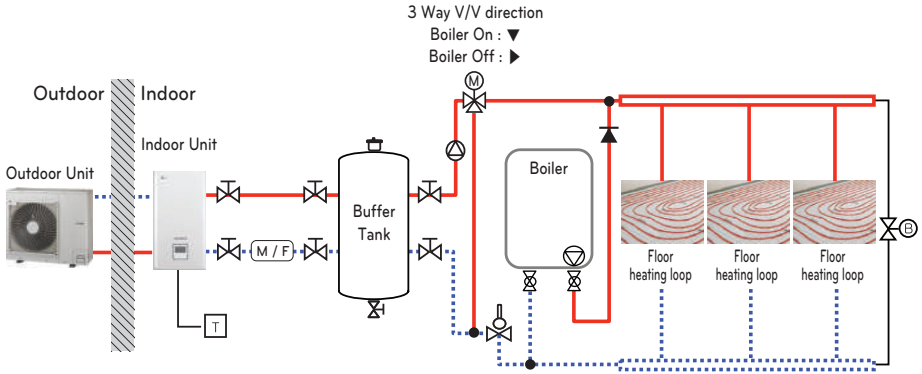

NOTE

- 3rd Party Boiler
 - 3rd party boiler can be controlled by manually via remote controller or automatically itself by means of comparing the outside air temperature and the pre-set temperature.
- 3way valve
 - Type of 3way valve and specification should be complied with chapter 8 of installation manual.

High Temperature	Room Thermostat(Field supply)	2way valve (Field supply)	3way valve (Field supply)
Low Temperature	Magnetic Filter (Mandatory)	By-pass valve(Field supply)	Pump(Field supply)
Shut-off valve	Check valve	Air vent (Field supply)	Aquastat V/V

(For Hydrosplit)

To protect the product, be sure to install a strainer on the water inlet pipe.

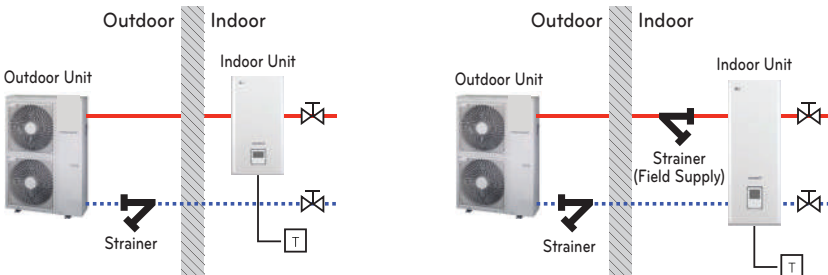

* Water In / Water Out installation scene may vary depending on the model.

Cycle Diagram (For R410A)

Outdoor unit 3 Series

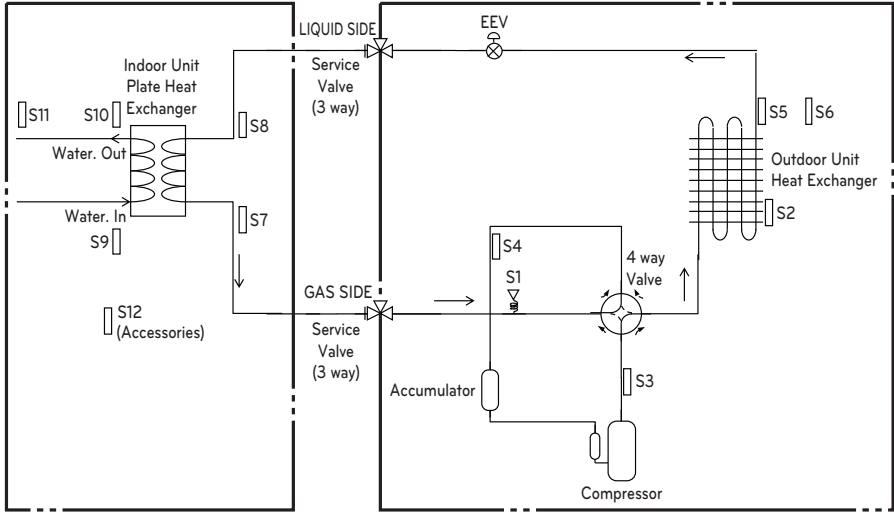

Outdoor unit 4 Series

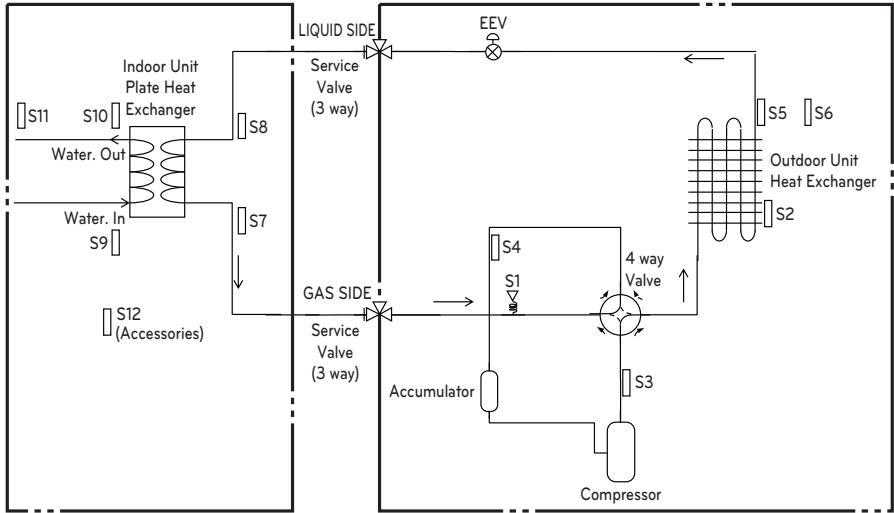

Description

Category	Symbol	Meaning	PCB Connector	Remarks
Outdoor Unit	S1	Pressure sensor	CN_H_PRESS	
	S2	Condenser middle temperature sensor	CN_MID	
	S3	Compressor-discharge pipe temperature sensor	CN_DISCHA	
	S4	Compressor-suction pipe temperature sensor	CN_SUCTION	
	S5	Condenser temperature sensor	CN_C_PIPE	- Description is expressed based on Cooling mode.
	S6	Outdoor air temperature sensor	CN_AIR	
	EEV	Electronic Expansion Valve	CN_EEV1_WH	
Indoor Unit	S7	PHEX gas temp. sensor	CN_PIPE_OUT	- Meaning is expressed based on Cooling mode.
	S8	PHEX liquid temp. sensor	CN_PIPE_IN	
	S9	Entering water temperature sensor	CN_TH3	
	S10	Leaving water temperature sensor		
	S11	Electric heater outlet temperature sensor		
	S12	Remote air temperature sensor	CN_ROOM	- Optional accessory (being sold separately) - Not shown in diagram

Cycle Diagram (For R32 Split)

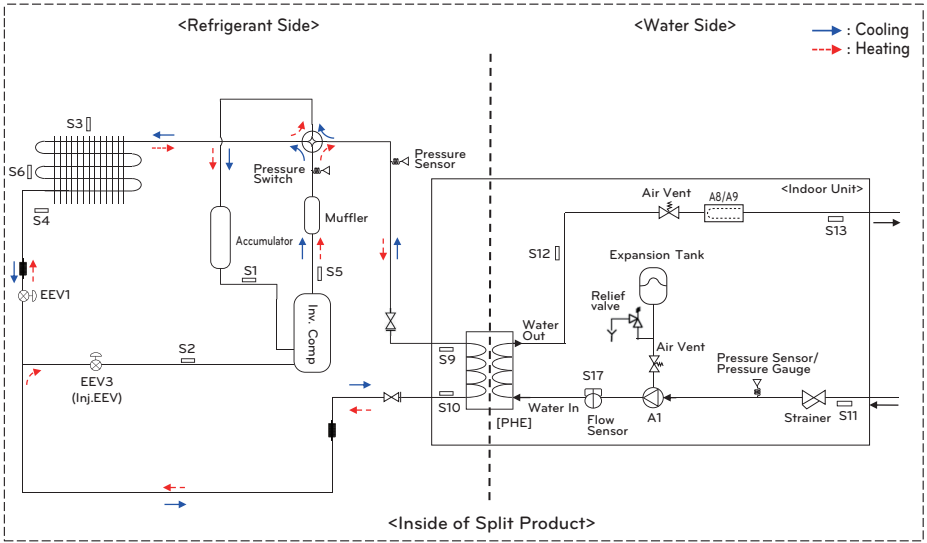

Description

Category	Symbol	Meaning	PCB Connector
Refrigerant side	S1	Compressor-suction pipe temperature sensor	CN_SUCTION
	S2	Inlet IHEX temperature sensor	CN_VI_IN
	S3	Outdoor air temperature sensor	CN_AIR
	S4	Outdoor-HEX temp. sensor	CN_C_PIPE
	S5	Compressor-discharge pipe temperature sensor	CN_DISCHARGE
	S6	Outdoor-HEX middle temp. sensor	CN_MID
	S9	PHEX gas temp. sensor	CN_PIPE/OUT
	S10	PHEX liquid temp. sensor	CN_PIPE/IN
	EEV1	Electronic Expansion Valve (Heating)	CN_EEV1
EEV3	Electronic Expansion Valve (Injection)	CN_EEV3	
Water Side	S11	Inlet water temperature sensor	CN_TH3
	S12	Outlet water temperature sensor	
	S13	Backup heater outlet sensor	
	S17	Flow sensor	CN_F_METER
	A1	Main water pump	CN_MOTOR1 CN_W_PUMP_A
	A8	Electric backup heater (Step 1)	CN_E_HEAT_A
	A9	Electric backup heater (Step 2)	CN_E_HEAT_B

Cycle Diagram (For Hydrosplit 1-Pipe)

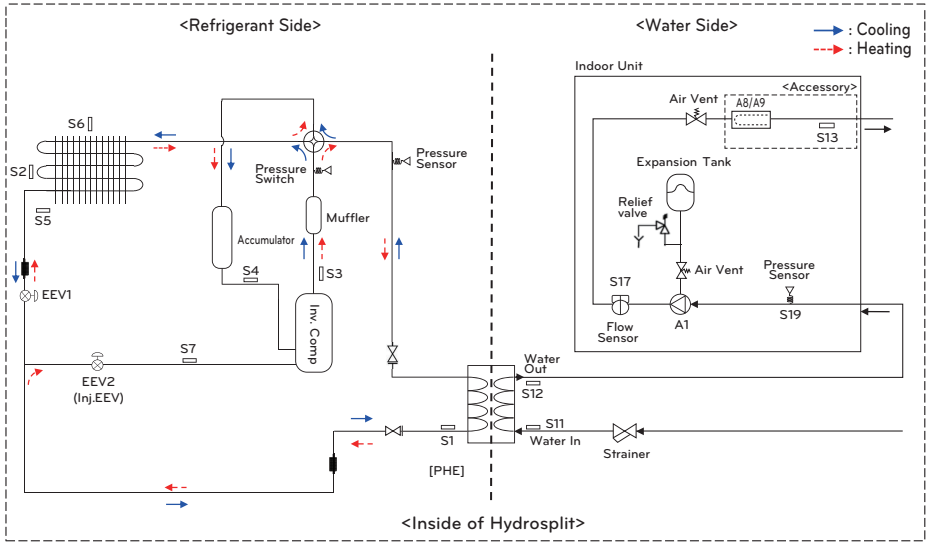

Description

Category	Symbol	Meaning	PCB Connector
Refrigerant side	S1	PHEX liquid temperature sensor	CN_PIPE_IN
	S2	Outdoor-HEX middle temperature sensor	CN_MID
	S3	Compressor-discharge pipe temperature sensor	CN_DISCHARGE
	S4	Compressor-suction pipe temperature sensor	CN_SUCTION
	S5	Outdoor-HEX temperature sensor	CN_C_PIPE
	S6	Outdoor air temperature sensor	CN_AIR
	S7	Compressor-injection pipe temperature sensor	CN_VI_IN
	EEV1	Electronic Expansion Valve (Heating/Cooling)	CN_EEV1
	EEV2	Electronic Expansion Valve (Injection)	CN_EEV_MAIN
Water Side	S12	Outlet water temperature sensor	CN_WATER_OUT
	S11	Inlet water temperature sensor	CN_WATER_IN
	S13	Backup heater outlet temperature sensor	CN_TH3
	S17	Flow sensor	CN_F_SENSOR
	S19	Water pressure sensor	CN_H2O_PRESS
	A1	Main Water Pump	CN_PUMP_A1 CN_MOTOR1
	A8	Electric backup heater (1Ø, Optional accessory)	CN_HEATER_PCB
A9	Electric backup heater (3Ø, Optional accessory)	HEATER1	

Cycle Diagram (For Hydrosplit 2-Pipe)

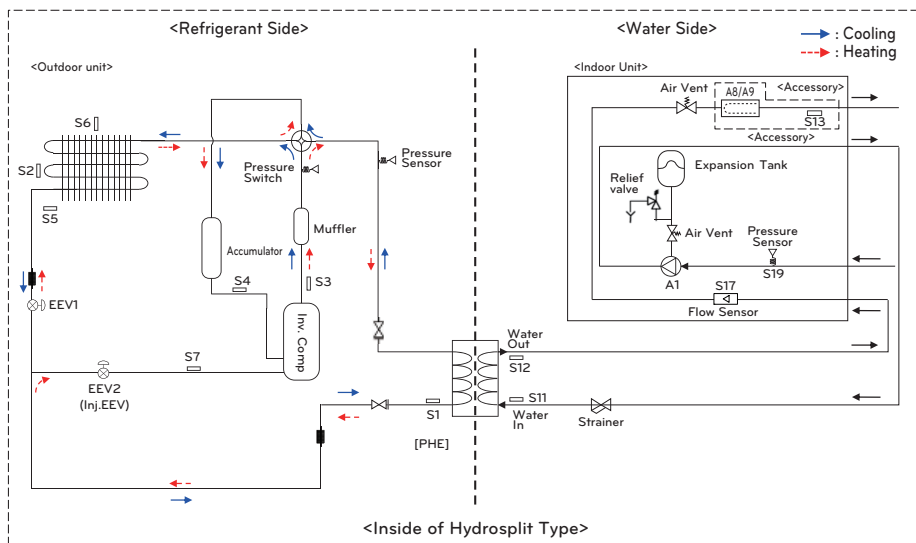

Description

Category	Symbol	Meaning	PCB Connector
Refrigerant side	S1	PHEX liquid temperature sensor	CN_PIPE_IN
	S2	Outdoor-HEX middle temperature sensor	CN_MID
	S3	Compressor-discharge pipe temperature sensor	CN_DISCHARGE
	S4	Compressor-suction pipe temperature sensor	CN_SUCTION
	S5	Outdoor-HEX temperature sensor	CN_C_PIPE
	S6	Outdoor air temperature sensor	CN_AIR
	S7	Compressor-injection pipe temperature sensor	CN_VI_IN
	EEV1	Electronic Expansion Valve (Heating/Cooling)	CN_EEV1
EEV2	Electronic Expansion Valve (Injection)	CN_EEV_MAIN	
Water Side	S12	Outlet water temperature sensor	CN_WATER_OUT
	S11	Inlet water temperature sensor	CN_WATER_IN
	S13	Backup heater outlet temperature sensor	CN_TH3
	S17	Flow sensor	CN_F_SENSOR
	S19	Water pressure sensor	CN_H2O_PRESS
	A1	Main Water Pump	CN_PUMP_A1 CN_MOTOR1
	A8	Electric backup heater (1Ø, Optional accessory)	CN_HEATER_PCB
A9	Electric backup heater (3Ø, Optional accessory)	HEATER1	

Water cycle (For R410A)

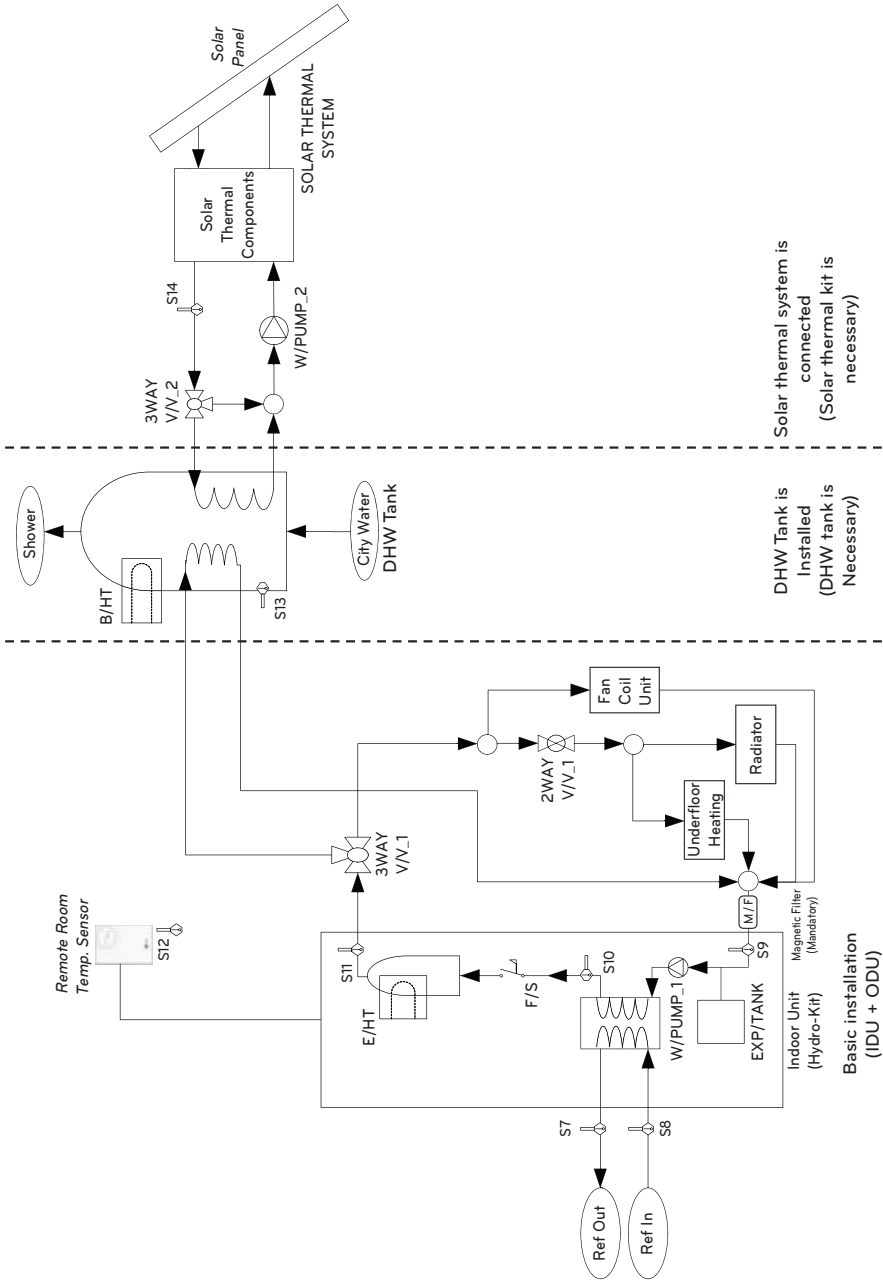

Solar thermal system is connected (Solar thermal kit is necessary)

DHW Tank is Installed (DHW tank is Necessary)

Basic installation (IDU + ODU)

Description (For R410A)

Category	Symbol	Meaning	PCB Connector	Remarks	
Indoor Unit	S7	Refrigerant temperature sensor (Gas side)	CN_PIPE_OUT	- Meaning is expressed based on Cooling mode.	
	S8	Refrigerant temperature sensor (Liquid side)	CN_PIPE_IN		
	S9	Entering Water temperature sensor	CN_TH3	- S9, S10 and S11 are connected at 6 pin type connector CN_TH3.	
	S10	Leaving Water temperature sensor			
	S11	Electric heater outlet temperature sensor			
	F/S	Flow Switch	CN_FLOW1		
	E/HT	Backup heater	CN_E/HEAT(A) CN_E/HEAT(B)	- Heating capacity is divided into two level : partial capacity by E/HEAT(A) and full capacity by E/HEAT(A) + E/HEAT(B). - Operating power(230 V AC 50 Hz) of E/HEAT(A) and E/HEAT(B) are supplied by external power source via relay connector and ELB.	
	W_PUMP1	Internal Water Pump	CN_MOTOR1	- Water Pump is connected at CN_MOTOR1	
	EXP/TANK	Expansion Tank	(no connector)	- Absorb volume change of heated water,	
	S12	Remote Air temperature sensor	CN_ROOM	- Optional accessory (sold separately) - Model : PQRSTAO	
	CTR/PNL	Control Panel (or 'Remote Controller')	CN_REMO	- Pre built-in at indoor unit	
2WAY V/V_1	To control water flow for Fan Coil Unit	CN_2WAY(A)	- 3 rd party accessory and Field installation (sold separately) - 2 wire NO or NC type 2way valve is supported.		
M / F	Magnetic Filter	(No connector)	- 3 rd party accessory and Field installation (sold separately) - It is Mandatory to install an additional filter on the heating water circuit.		
Water Heating	W/TANK	DHW Tank	(No connector)	- 3 rd party accessory and Field installation (sold separately) - Generating and storing DHW by AWHP or built-in electric heater	
	B/HT	Booster heater	CN_B/HEAT(A)	- 3 rd party accessory and Field installation (usually built-in at W/TANK) - Supplying additional water heating capacity.	
	3WAY V/V_1	- Flow control for water which is leaving from indoor unit. - Flow direction switching between underfloor and water tank	CN_3WAY(A)	- 3 rd party accessory and Field installation (sold separately) - SPDT type 3way valve is supported.	
	CITY WATER	Water to be heated by Indoor unit and B/HT of W/TANK	(no connector)	- Field installation	
	SHOWER	Water supplied to end-user	(no connector)	- Field installation	
	S13	W/TANK water temperature sensor	CN_TH4	- S13 and S14 are connected at 4 pin type connector CN_TH4. - S13 is a part of DHW tank kit. (Model : PHLTA, PHLTC) - S14 is a part of solar thermal kit (Model:PHLLA)	
S14	Solar-heated water temperature sensor				
3WAY V/V_2	- Flow control for water which is heated and circulated by SOLAR THERMAL SYSTEM. - Flow direction switching between SOLAR THERMAL SYSTEM and W/TANK	CN_3WAY(B)			- 3 rd party accessory and Field installation (sold separately) - SPDT type 3way valve is supported.
W_PUMP/2	External Water Pump	CN_W/PUMP(B)			- 3 rd party accessory and Field installation (sold separately) - If water pump of SOLAR THERMAL SYSTEM is incapable of circulation, external water pump can be used.
SOLAR THERMAL SYSTEM	- This system can include following components : Solar panel, Sensors, Thermostats, Interim heat exchanger, Water pump, etc. - To utilized hot water heated by SOLAR THERMAL SYSTEM, end-user must install Solar-Kit accessory (PHLLA) provided by LG	(no connector)	- 3 rd party accessory and Field installation (sold separately)		

Water cycle (For Split R32)

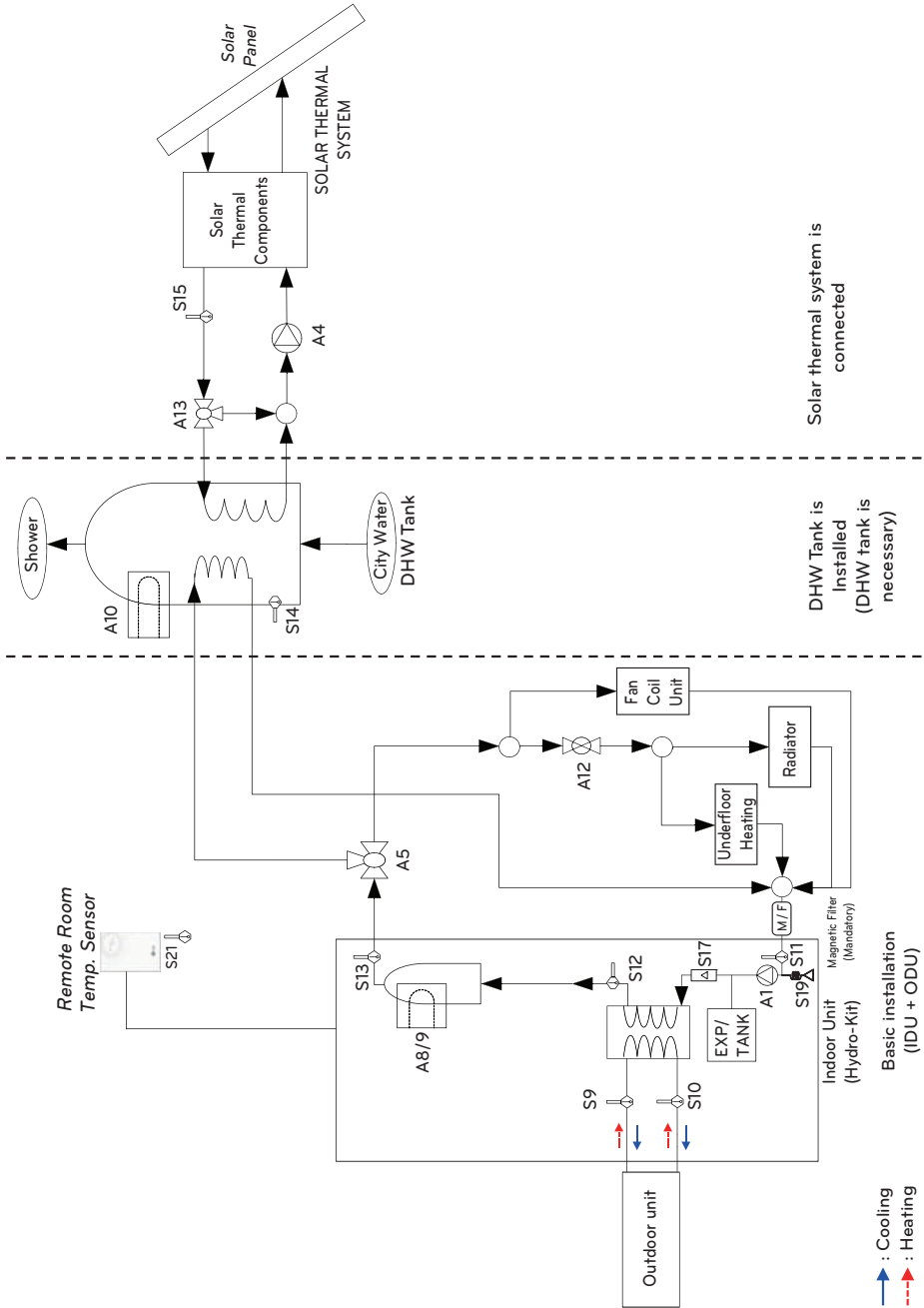

Description (For Split R32)

Category	Symbol	Meaning	PCB Connector	Remarks
Indoor unit / Main circuit	S9	Refrigerant temperature sensor (Gas side)	CN_PIPE_OUT	- NTC5kOhm
	S10	Refrigerant temperature sensor (Liquid side)	CN_PIPE_IN	- NTC5kOhm
	S11	Entering water temperature sensor	CN_TH3 (WATER IN)	- NTC5kOhm - S11,S12 and S13 are connected at 6-pin-type connector CN_TH3
	S12	Leaving water temperature sensor	CN_TH3 (PHEX OUT)	
	S13	Backup heater outlet temperature sensor	CN_TH3 (HEATER OUT)	
	S17	Flow Sensor	CN_F_SENSOR	- to monitor water flow rate
	S19	Entering Water Pressure sensor	CN_H2O_PRESS	- to monitor water pressure
	S20	Reserved	TB_SENSOR (AMBIENT)	
	S21	Remote room air sensor (Direct circuit)	CN_ROOM1	- Accessory: PQRSTA0 - NTC10kOhm
	A1	Internal water pump	CN_PUMP_A1 CN_MOTOR1	- Power is supplied via CN_PUMP_A1 - PWM signal is supplied via CN_MOTOR1
	A2	External pump	TB_EXT (PUMP A2)	- voltage-free contact - External water pump if head of internal pump is not sufficient or if parallel buffer tank is used
	A8 / A9	Backup heater (2 steps)	Coil 1: CN_L1, CN_N1 Coil 2: CN_L2, CN_N2 on HEATER-PCB	- Operating power(230 V AC 50 Hz) is supplied by external power source via Terminal block
	A12	2-way valve to block underfloor circuit from cooling water	CN_2WAY_A	- 3rd party accessory and Field installation (sold separately) - 2-wire NO- or NC-type 2-way valve is supported.
	EXP/TANK	Expansion vessel	-	- Absorbs volume change of eating water
CTR/PNL	Control panel / Remote controller	CN_REMO		
M/F	Magnetic filter	-	- 3rd party accessory and Field installation (sold separately) - It is Mandatory to install an additional filter on the heating water circuit.	
Domestic hot water circuit	S14	DHW tank temperature	CN_TH4 (BOOST)	- S14 is connected at 4-pin-type connector CN_TH4 - Accessory: PHRSTA0 - S14 is a part of DHW Tank kit (Model : PHLTA)
	A5	3-way valve for changing between heating (cooling) and DHW tank	CN_3WAY_A	- 3rd party accessory and Field installation (sold separately) - SPDT type 3way valve is supported.
	A10	DHW booster heater	CN_TANK_HEATER	- 3rd party accessory and Field installation (sold separately) - Operating power (230 V AC 50 Hz) is supplied by external power source via Terminal block - Accessory: PHLTA (Relay, harness and DHW sensor)
	W/TANK	Domestic hot water tank	-	- Accessory (OSHW-series) or third-party tank suitable for heat pumps
	A15	Reserved	CN_PUMP_A15	
	S23	Reserved	CN_RECIRC	
Solar thermal circuit	S15	Solar collector sensor	TB_SENSOR (SOLAR)	- 3rd party accessory and Field installation (sold separately) - PT100
	S16	Reserved	CN_TH4 (SOLAR)	- for solar collector sensor use S15
	A4	Solar collector pump	CN_PUMP_A4	- 3rd party accessory and Field installation (sold separately)
	A13	3way-valve Solar	CN_3WAY_B	- 3rd party accessory and Field installation (sold separately) - SPDT type 3way valve is supported.
	Solar thermal system	Solar thermal equipment such as collector, solar pump, PT1000 sensor, solar heat-exchanger	-	- 3rd party accessory and Field installation (sold separately)

Water cycle (For Hydrosplit 1-Pipe)

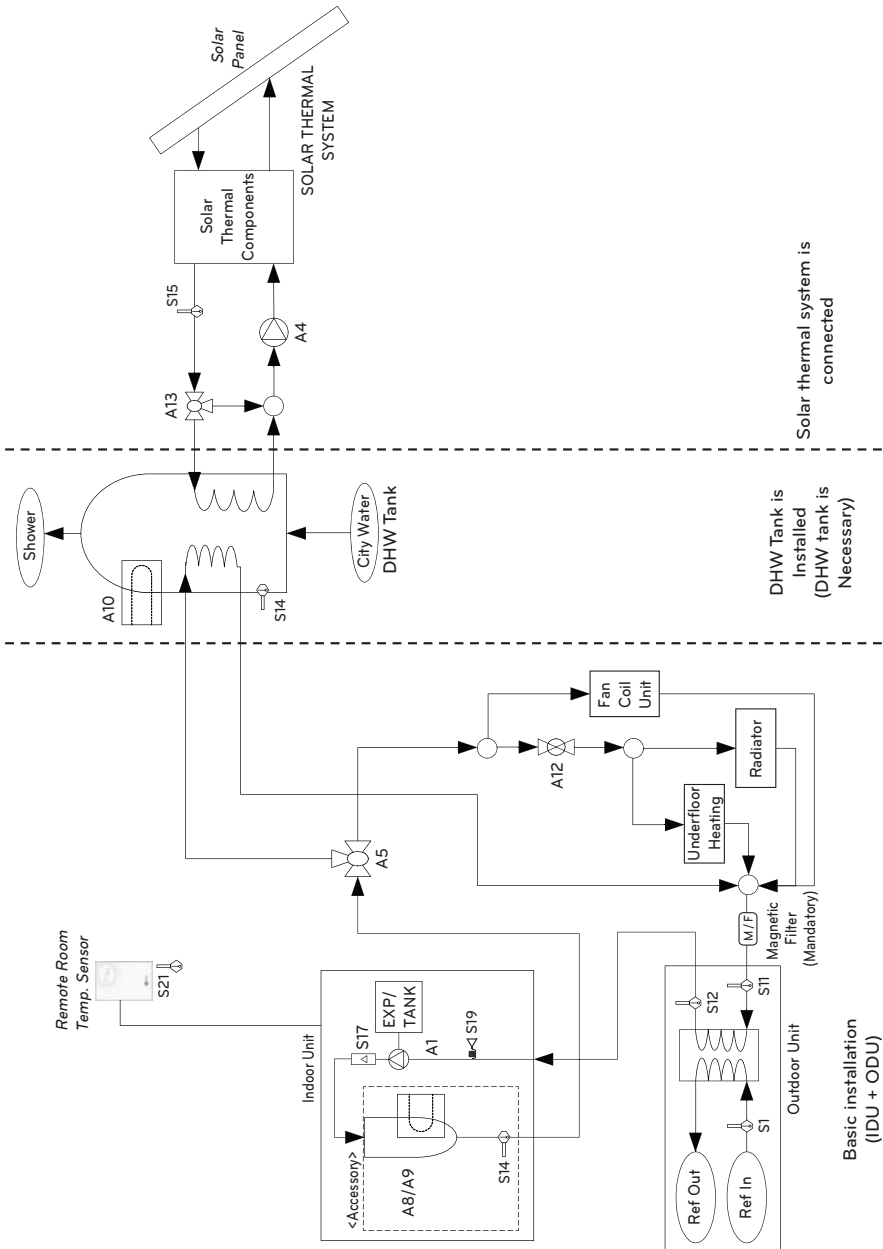

Water cycle (For Hydrosplit 2-Pipe)

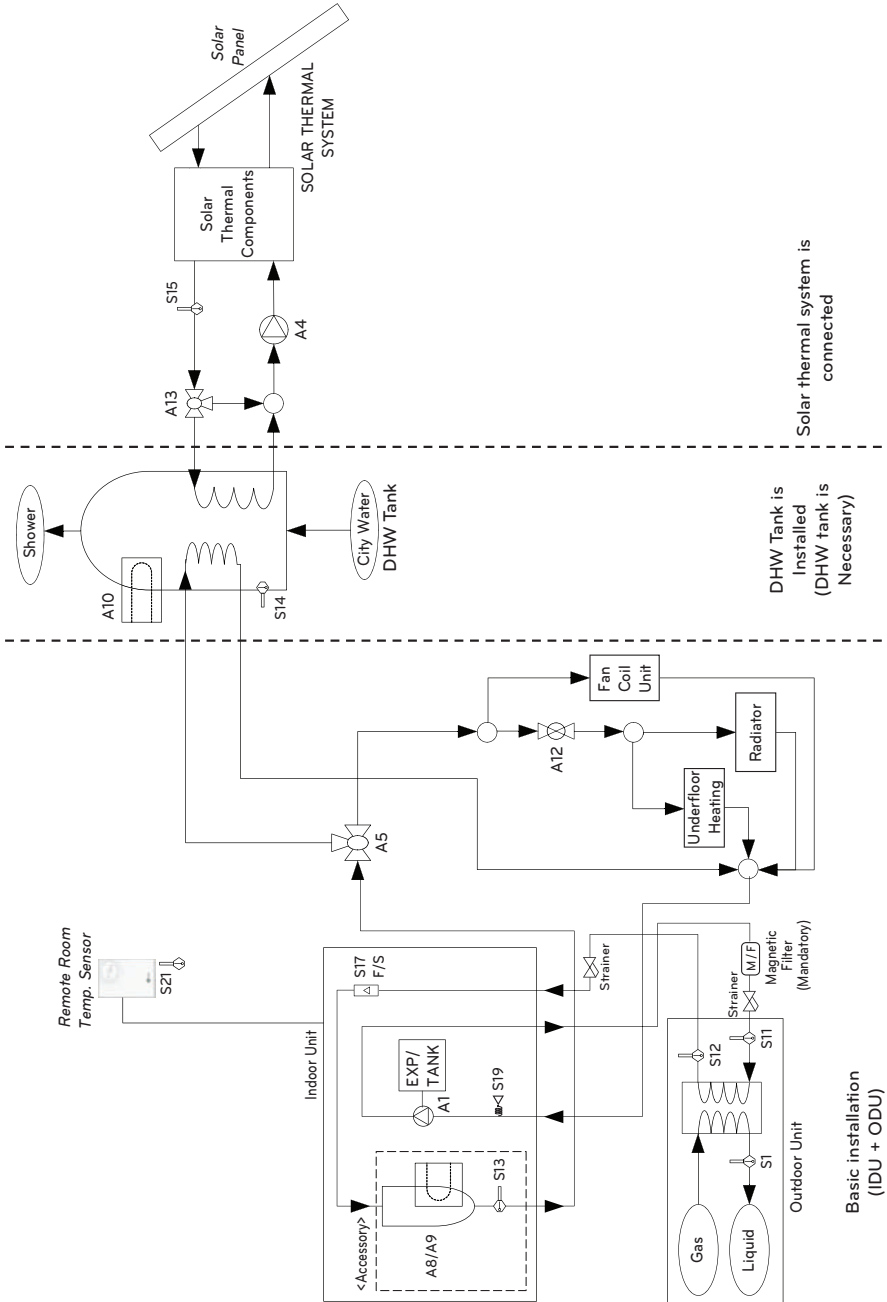

Description (For Hydrosplit)

Category	Symbol	Meaning	PCB Connector	Remarks
Outdoor Unit	S1	Refrigerant temperature sensor (Liquid side)	CN_PIPE_IN	Meaning is expressed based on Cooling mode.
	S11	Inlet water temperature sensor	CN_WATER_IN	Entering water temperature sensor
	S12	Outlet water temperature sensor	CN_WATER_OUT	Leaving water temperature sensor
	M/F	Magnetic Filter	(No connector)	- 3rd party accessory and Field installation (sold separately) - It is Mandatory to install an additional filter on the heating water circuit.
Indoor Unit	S19	Entering Water Pressure sensor	CN_H2O_PRESS	
	A8/A9	Backup Heater	(No connector)	- Optional accessory (sold separately) - HA061B E1 : 1Ø, HA063B E1 : 3Ø
	S13	Backup heater outlet temperature sensor	CN_TH3	- Accessory supplied with Backup heater
	A1	Internal Water Pump	CN_MOTOR1 CN_PUMP_A1	- Water Pump is connected at CN_MOTOR1 and CN_PUMP_A1
	A2	External pump	TB_EXT (PUMP A2)	- voltage-free contact - External water pump if head of internal pump is not sufficient or if parallel buffer tank is used
	EXP/TANK	Expansion Tank	(No connector)	- Absorb volume change of heated water.
	S17	Flow sensor	CN_F_SENSOR	
	S21	Remote room air sensor (Direct circuit)	CN_ROOM2	- Optional accessory (sold separately) - PQRSTA0
	CTR/PNL	Control Panel (or 'Remote Controller')	CN_REMO	- Pre built-in at indoor unit
Water Heating	A12	To control water flow for Fan Coil Unit	CN_2WAY_A	- 3 rd party accessory and Field installation (sold separately) - 2 wire NO or NC type 2way valve is supported
	W/TANK	DHW Tank	(No connector)	- 3 rd party accessory and Field installation (sold separately) - Generating and storing DHW by AWHP or built-in electric heater
	A10	Booster Heater	CN_TANK_HEATER	- 3 rd party accessory and Field installation (usually built-in at W/TANK) - Supplying additional water heating capacity
	A5	- Flow control for water which is leaving from indoor unit. - Flow direction switching between underfloor and water tank.	CN_3WAY_A	- 3 rd party accessory and Field installation (sold separately)
	CITY WATER	Water to be heated by indoor unit and B/HT of W/TANK	(No connector)	- Field installation
	SHOWER	Water supplied to end-user	(No connector)	- Field installation
Solar Heating	S14	W/TANK water temperature sensor	CN_TH4	- S14 are connected at 4 pin type connector CN_TH4 - S14 is a part of DHW tank kit (Model : PHLTA, PHLTC)
	S15	Solar-heated water temperature sensor	TB_SENSOR SOLAR	- 3rd party accessory and Field installation (sold separately) - PT1000
	A13	- Flow control for water which is heated and circulated by SOLAR THERMAL SYSTEM. - Flow direction switching between SOLAR THERMAL SYSTEM and W/TANK	CN_3WAY_B	- 3 rd party accessory and Field installation (sold separately) - SPDT type 3way valve is supported
	A4	Solar collector pump	CN_PUMP_A4	- 3 rd party accessory and Field installation (sold separately) - If water pump of SOLAR THERMAL SYSTEM is incapable of circulation, external water pump can be used.
	SOLAR THERMAL SYSTEM	- This system can include following components : Solar panel, Sensor, Thermostats, Interim heat exchanger, Water pump, etc.	(No connector)	- 3 rd party accessory and Field installation (sold separately)

INSTALLATION OF OUTDOOR UNIT

The outdoor unit of **THERMAV™** is installed outside to exchange heat with ambient air. Therefore, it is important to secure proper space around the outdoor unit and care for specific external conditions. This chapter presents a guide to install the outdoor unit, make a route to connect with the indoor, and what to do when installed around seaside.

Conditions where Outdoor Unit is Installed

- If a sunroof is built over the unit to prevent direct sunlight or rain exposure, make sure that heat radiation from the heat exchanger is not restricted.
- Ensure that the spaces indicated by arrows around front, back and side of the unit.
- Do not place animals and plants in the path of the warm air.
- Take the weight of the outdoor unit into account and select a place where noise and vibration are minimum.
- Select a place so that the warm air and noise from the outdoor unit do not disturb neighbors.
- Place that can sufficiently endure the weight and vibration of the outdoor unit and where even Installation is possible.
- Place that has no direct influence of snow or rain.
- Place with no danger of snowfall or icicle drop.
- Place without weak floor of base such as decrepit part of the building or with a lot of snow accumulation.

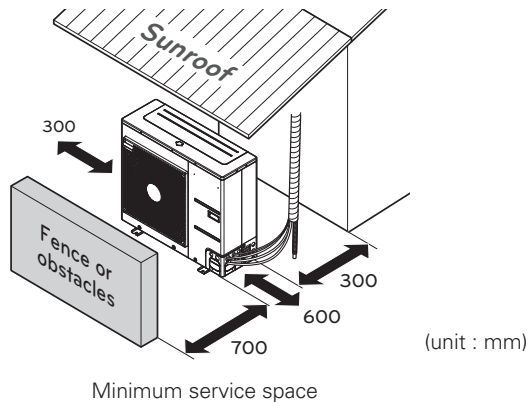

※ The feature may be vary according to the type of model.

Drill a Hole in the Wall (For Split)

- If making a hole to the wall is required to connect pipe between the indoor unit and the outdoor unit, please follow below descriptions.
Drill the piping hole with a $\varnothing 70$ mm hole core drill.
Piping hole should be slightly slant to the outdoor side to prevent raindrop into indoor side.

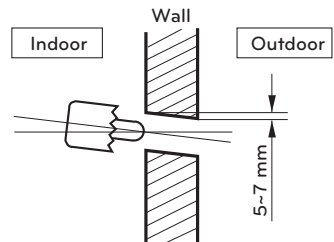

Transporting the Unit

- When carrying the suspended unit, pass the ropes between legs of base panel under the unit.
- Always lift the unit with ropes attached at four points so that impact is not applied to the unit.
- Attach the ropes to the unit at an angle A of 40° or less.
- Use only accessories and parts which are of the designated specification when installing.
- Forklift trucks are not available without a palette.
- Be careful not to damage the product when moving the forklift.

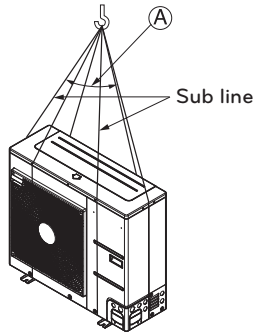

A 40° or less

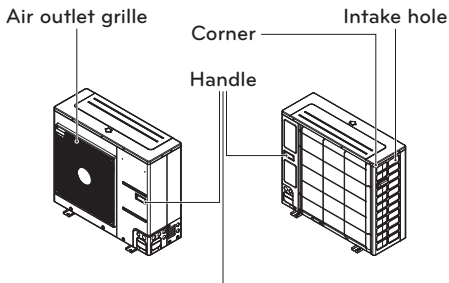
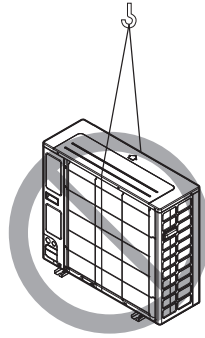

Always hold the unit by the corners, as holding it by the side intake holes on the casing may cause them to deform.

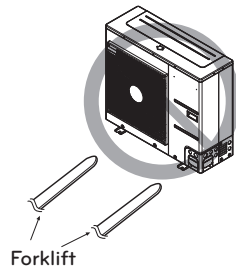

 **CAUTION**

Be very careful while carrying the product.

- Do not have only one person carry product if it is more than 20 kg.
- PP bands are used to pack some products. Do not use them as a mean for transportation because they are dangerous.
- Do not touch heat exchanger fins with your bare hands. Otherwise you may get a cut in your hands.
- Tear plastic packaging bag and scrap it so that children cannot play with it. Otherwise plastic packaging bag may suffocate children to death.
- When carrying in Unit, be sure to support it at four points. Carrying in and lifting with 3-point support may make Outdoor Unit unstable, resulting in a fall.
- Use 2 belts of at least 8 m long.
- Place extra cloth or boards in the locations where the casing comes in contact with the sling to prevent damage.
- Hoist the unit making sure it is being lifted at its center of gravity.

Installation at Seaside

⚠ CAUTION

- Unit should not be installed in areas where corrosive gases, such as acid or alkaline gas, are produced.
- Do not install the product where it could be exposed to sea wind (salty wind) directly. It can result corrosion on the product. Corrosion, particularly on the condenser and evaporator fins, could cause product malfunction or inefficient performance.
- If outdoor unit is installed close to the seaside, it should avoid direct exposure to the sea wind. Otherwise it needs additional anti-corrosion treatment on the heat exchanger.

Selecting the location(Outdoor Unit)

- If the outdoor unit is to be installed close to the seaside, direct exposure to the sea wind should be avoided. Install the outdoor unit on the opposite side of the sea wind direction.

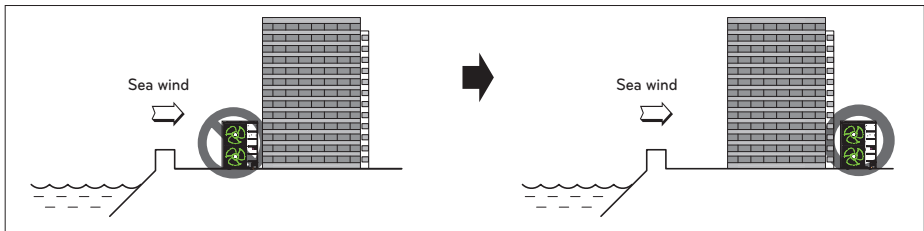

- In case, to install the outdoor unit on the seaside, set up a windbreak not to be exposed to the sea wind.

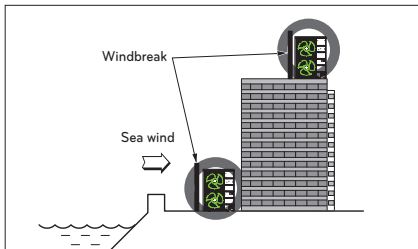

- It should be strong enough like concrete to prevent the sea wind from the sea.
- The height and width should be more than 150% of the outdoor unit.
- It should be keep more than 700 mm of space between outdoor unit and the windbreak for easy air flow.

- Select a well-drained place.

Periodic (more than once/year) cleaning of the dust or salt particles stuck on the heat exchanger by using water.

- If you can't meet above guide line in the seaside installation, please contact your supplier for the additional anti-corrosion treatment.

Seasonal wind and cautions in winter

- Sufficient measures are required in a snow area or severe cold area in winter so that product can be operated well.
- Get ready for seasonal wind or snow in winter even in other areas.
- Install a suction and discharge duct not to let in snow or rain.
- Install the outdoor unit not to come in contact with snow directly. If snow piles up and freezes on the air suction hole, the system may malfunction. If it is installed at snowy area, attach the hood to the system.
- Install the outdoor unit at the higher installation console by 500 mm than the average snowfall (annual average snowfall) if it is installed at the area with much snowfall.
- Where snow accumulated on the upper part of the Outdoor Unit by more than 100 mm, always remove snow for operation.
 - The height of H frame must be more than 2 times the snowfall and its width shall not exceed the width of the product. (If width of the frame is wider than that of the product, snow may accumulate)
 - Don't install the suction hole and discharge hole of the Outdoor Unit facing the seasonal wind.

INSTALLATION OF INDOOR UNIT

The indoor unit of **THERMAV** is installed inside where terminal of under floor water pipe cycle and refrigerant pipe from the outdoor unit are accessible at the same time.

In this chapter conditions for installation place is described. In addition, considerations when installing accessories or 3rd party accessories are described, too.

Conditions where Indoor Unit is Installed

Specific conditions are required for installation place such as service space, wall mounting, water pipe length and height, total volume of water, adjusting expansion vessel, and water quality.

General Considerations

Followings are should be considered before the installation of the indoor unit.

- The installation place should be free from outdoor weather conditions such as rain, snow, wind, frost, etc.
- Choose the place where is water-resistant or good drainage.
- Service space should be secured.
- No flammable materials around the indoor unit.
- Mice can not be appeared to prevent entering the indoor unit or attacking wires.
- Do not place anything in front of the indoor unit to ensure air circulation around the indoor unit.
- Do not locate anything under the indoor unit to be free from unexpected water out.
- In case of water pressure increasing to 3 bar, water drainage should be treated when water is drained by safety valve.

Service Space

- Ensure that the spaces indicated by arrows around bottom, side, and top side.
- Wider spaces are preferred for easy maintenance and piping.
- If minimum service space is not secured, air circulation can be troubled and internal parts of the indoor unit can be damaged by overheating.

NOTE

- The default setting of the product is for heating only. To use the cooling system together, DIP S / W 4 should be turned ON and additional drain pan accessory should be installed.

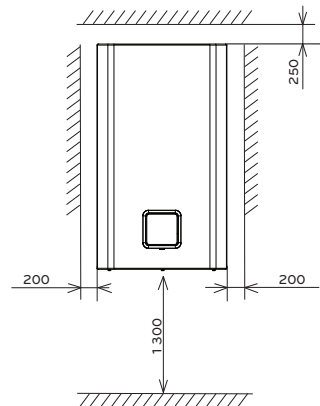

Minimum service space
(unit : mm)

Mounting to Wall

Step 1. Disconnect the remote control case from the front panel and disconnect the remote control cable.

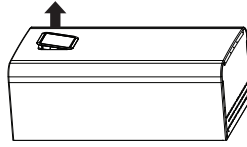
**CAUTION**

After installation is completed, return the remote control to its original state.

NOTE

Use a flat-blade screwdriver or a coin to remove the remote control case.

Step 2. After releasing five screws, detach front cover from the indoor unit. While detaching the front cover, grab the left and right sides of the front cover. Then pull into upward direction.

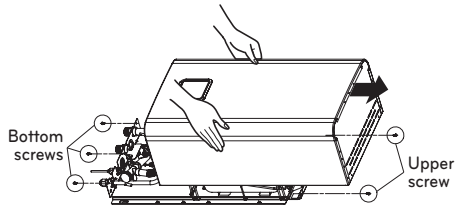

Step 3. Attach "Installation Sheet" to the wall and mark the location of bolts. This sheet helps to find correct location to the bolts.

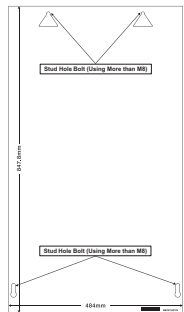
**CAUTION**

The sheet should be attached level. If not, the supporting plate and the indoor unit will not be mounted correctly.

Step 4. Detach the Installation sheet. Screw bolts at the hole marks on the wall.
When screwing bolts, use M8 ~ M11 anchor bolts to secure hanging the indoor unit.

NOTE

Self drilling screw can be used as alternatives of M8 ~ M11 anchor bolts. But M8 ~ M11 anchor bolts are more preferred.

Step 5. Hang the indoor unit at the supporting plate.

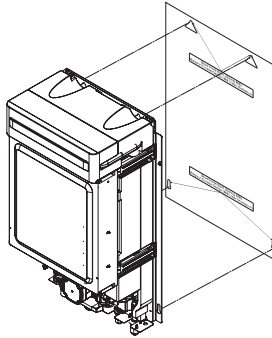

Floor area requirement : indoor unit (For R32 Split)

- If the total refrigerant charge (m_c) is in system ≥ 1.842 kg, additional minimum floor area requirements is complied in the following flow chart.

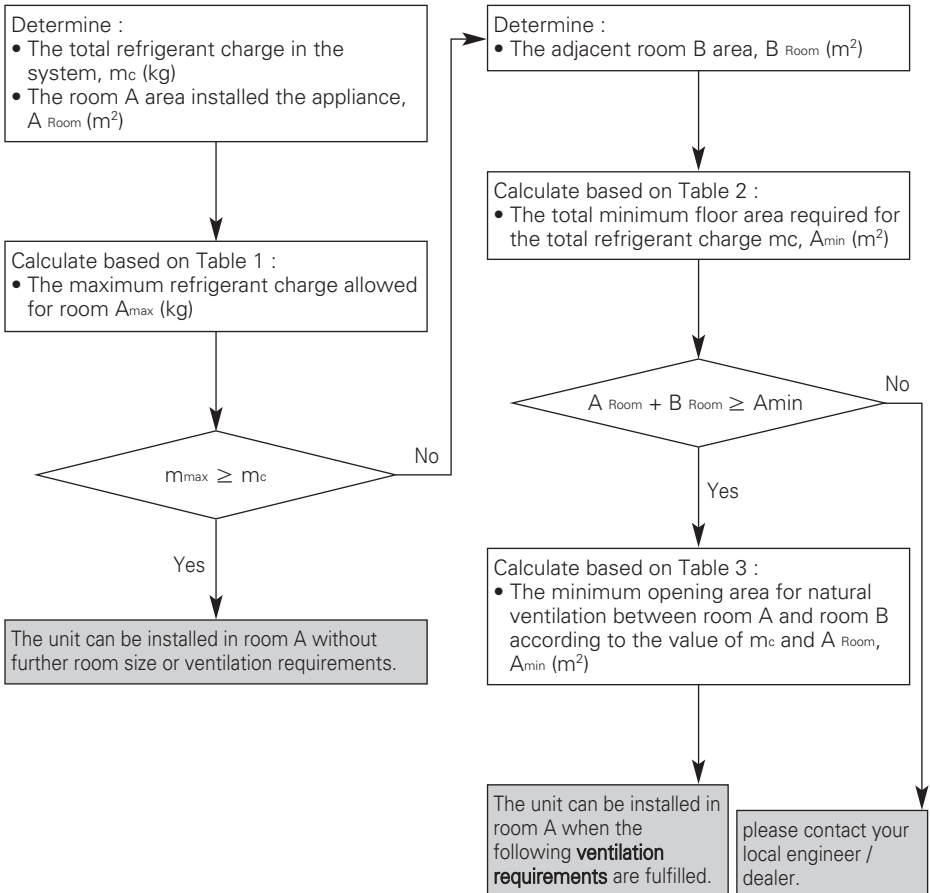
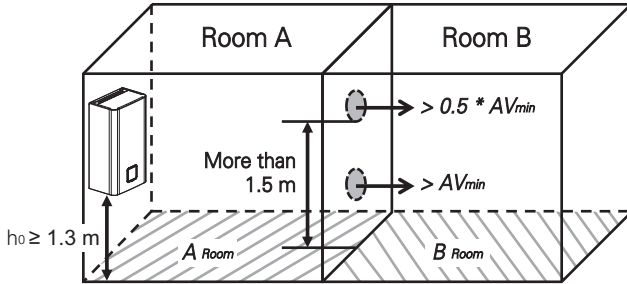

Ventilation requirements

- Two ventilation openings, one at bottom, another at top, for ventilation purposes are made between room A and room B.
- **Bottom opening :**
 - Must comply to the minimum area requirement of AV_{min} .
 - Opening must be located 300 mm from the floor.
 - At least 50 % of required opening area must be 200 mm from the floor.
 - The bottom of the opening shall not be higher than the point of release when the unit is installed and must be situated 100 mm above the floor.
 - Must be as close as possible to the floor and lower than h_0 .
(h_0 = Installation height)
- **Top opening :**
 - The total size of the Top opening must be more than 50 % of AV_{min} .
 - Opening must be located 1 500 mm above the floor.
- The height of the openings between the wall and floor which connect the rooms are not less than 20 mm.
- Ventilation openings to the outside are NOT considered suitable ventilation openings (the user can block them when it is cold).

Table 1 - Maximum refrigerant charge allowed in a room

A_{room} (m^2)	Maximum refrigerant charge in a room m_{max} (kg)					
	Based on h_0 (m)					
	1.3	1.4	1.5	1.6	1.7	1.8
1	0.30	0.32	0.35	0.37	0.39	0.41
2	0.60	0.64	0.69	0.74	0.78	0.83
3	0.90	0.97	1.04	1.11	1.17	1.24
4	1.20	1.29	1.38	1.47	1.57	1.66
5	1.50	1.61	1.73	1.84	1.96	2.07
6	1.80	1.93	2.07	2.21	2.35	2.49
7	1.96	2.12	2.27	2.42	2.57	2.72
8	2.10	2.26	2.42	2.59	2.75	2.91
9	2.23	2.40	2.57	2.74	2.91	3.09
10	2.35	2.53	2.71	2.89	3.07	3.25
11	2.46	2.65	2.84	3.03	3.22	3.41
12	2.57	2.77	2.97	3.17	3.36	3.56
13	2.68	2.88	3.09	3.30	3.50	3.71
14	2.78	2.99	3.21	3.42	3.63	3.85
15	2.88	3.10	3.32	3.54	3.76	3.98
16	2.97	3.20	3.43	3.66	3.88	4.11
17	3.06	3.30	3.53	3.77	4.00	4.24
18	3.15	3.39	3.64	3.88	4.12	4.36

NOTE

- h_0 : Installation height, height measured from the bottom of the casing to the floor
- For intermediate $A_{room A}$ values, the value that corresponds to the lower $A_{room A}$ value from the table is considered.
(If $A_{room A}=10.5 m^2$, consider the value that corresponds to $A_{room A} = 10 m^2$.)

Table 2 - Minimum floor area

Total Ref. Amount m_c (kg)	Minimum Floor Area A_{min} (m ²)					
	Based on h_o (m)					
	1.3	1.4	1.5	1.6	1.7	1.8
1.84	6.15	5.71	5.33	4.99	4.70	4.44
1.86	6.27	5.77	5.39	5.05	4.75	4.49
1.88	6.41	5.83	5.44	5.10	4.80	4.54
1.90	6.54	5.89	5.50	5.16	4.85	4.58
1.92	6.68	5.96	5.56	5.21	4.91	4.63
1.94	6.82	6.02	5.62	5.27	4.96	4.68
1.96	6.96	6.08	5.67	5.32	5.01	4.73
1.98	7.11	6.14	5.73	5.37	5.06	4.78
2.00	7.25	6.25	5.79	5.43	5.11	4.83
2.02	7.40	6.38	5.85	5.48	5.16	4.87
2.04	7.54	6.51	5.91	5.54	5.21	4.92
2.06	7.69	6.63	5.96	5.59	5.26	4.97
2.08	7.84	6.76	6.02	5.65	5.31	5.02
2.10	8.00	6.89	6.08	5.70	5.37	5.07
2.12	8.15	7.03	6.14	5.75	5.42	5.12
2.14	8.30	7.16	6.24	5.81	5.47	5.16
2.16	8.46	7.29	6.35	5.86	5.52	5.21
2.18	8.62	7.43	6.47	5.92	5.57	5.26
2.20	8.77	7.57	6.59	5.97	5.62	5.31
2.22	8.93	7.70	6.71	6.03	5.67	5.36
2.24	9.10	7.84	6.83	6.08	5.72	5.40
2.26	9.26	7.98	6.96	6.13	5.77	5.45
2.28	9.42	8.13	7.08	6.22	5.82	5.50
2.30	9.59	8.27	7.20	6.33	5.88	5.55
2.32	9.76	8.41	7.33	6.44	5.93	5.60
2.34	9.93	8.56	7.46	6.55	5.98	5.65
2.36	10.10	8.71	7.58	6.67	6.03	5.69
2.38	10.27	8.85	7.71	6.78	6.08	5.74
2.40	10.44	9.00	7.84	6.89	6.13	5.79
2.42	10.62	9.15	7.97	7.01	6.21	5.84
2.44	10.79	9.31	8.11	7.13	6.31	5.89
2.46	10.97	9.46	8.24	7.24	6.42	5.94
2.48	11.15	9.61	8.38	7.36	6.52	5.98
2.50	11.33	9.77	8.51	7.48	6.63	6.03
2.52	11.51	9.93	8.65	7.60	6.73	6.08
2.54	11.70	10.09	8.79	7.72	6.84	6.13
2.56	11.88	10.24	8.92	7.84	6.95	6.20
2.58	12.07	10.41	9.06	7.97	7.06	6.29
2.60	12.26	10.57	9.21	8.09	7.17	6.39
2.62	12.44	10.73	9.35	8.22	7.28	6.49
2.64	12.64	10.89	9.49	8.34	7.39	6.59
2.66	12.83	11.06	9.64	8.47	7.50	6.69
2.68	13.02	11.23	9.78	8.60	7.61	6.79
2.70	13.22	11.40	9.93	8.72	7.73	6.89
2.72	13.41	11.57	10.07	8.85	7.84	7.00
2.74	13.61	11.74	10.22	8.99	7.96	7.10
2.76	13.81	11.91	10.37	9.12	8.08	7.20
2.78	14.01	12.08	10.52	9.25	8.19	7.31
2.80	14.21	12.26	10.68	9.38	8.31	7.41

Total Ref. Amount m_c (kg)	Minimum Floor Area A_{min} (m ²)					
	Based on h_o (m)					
	1.3	1.4	1.5	1.6	1.7	1.8
2.82	14.42	12.43	10.83	9.52	8.43	7.52
2.84	14.62	12.61	10.98	9.65	8.55	7.63
2.86	14.83	12.79	11.14	9.79	8.67	7.74
2.88	15.04	12.97	11.29	9.93	8.79	7.84
2.90	15.25	13.15	11.45	10.07	8.92	7.95
2.92	15.46	13.33	11.61	10.20	9.04	8.06
2.94	15.67	13.51	11.77	10.34	9.16	8.17
2.96	15.88	13.70	11.93	10.49	9.29	8.29
2.98	16.10	13.88	12.09	10.63	9.41	8.40
3.00	16.32	14.07	12.26	10.77	9.54	8.51
3.02	16.53	14.26	12.42	10.92	9.67	8.62
3.04	16.75	14.45	12.58	11.06	9.80	8.74
3.06	16.98	14.64	12.75	11.21	9.93	8.85
3.08	17.20	14.83	12.92	11.35	10.06	8.97
3.10	17.42	15.02	13.09	11.50	10.19	9.09

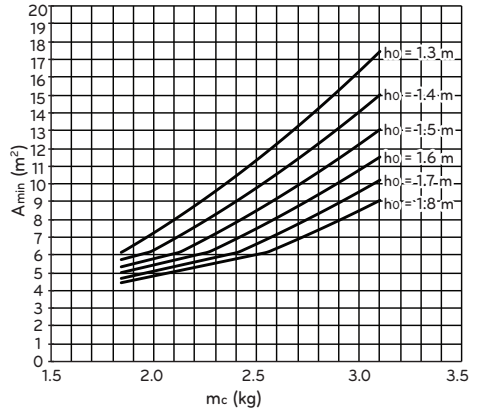

NOTE

- h_o : Installation height, height measured from the bottom of the casing to the floor
- For intermediate m_c values, the value that corresponds to the higher m_c value from the table is considered. (If $m_c = 1.85$ kg, the value that corresponds to $m_c = 1.86$ kg is considered.)
- Systems with total refrigerant charge lower than 1.84 kg are not subjected to any room area requirements.
- Charges above 3.10 kg are not allowed in the unit.

A_{room} (m^2)	Minimum opening area An_{vmin} (cm^2) (Based on h_0 1.7 m)													
	Total Ref. Amount (kg)													
	3.1	3.0	2.9	2.8	2.7	2.6	2.5	2.4	2.3	2.2	2.1	2.0	1.9	
1	651	627	603	579	555	531	507	483	459	435	411	387	363	
2	557	533	509	485	461	437	413	389	365	341	317	293	268	
3	463	439	415	391	367	343	319	295	271	247	222	198	174	
4	369	345	321	297	273	249	225	201	176	152	128	104	80	
5	275	251	227	203	179	155	130	106	82	58	34	10		
6	181	157	133	108	84	60	36	12						
7	132	107	82	57	32	8								
8	91	65	39	14										
9	49	23												
10	8													

A_{room} (m^2)	Minimum opening area An_{vmin} (cm^2) (Based on h_0 1.8 m)													
	Total Ref. Amount m_c (kg)													
	3.1	3.0	2.9	2.8	2.7	2.6	2.5	2.4	2.3	2.2	2.1	2.0	1.9	
1	627	604	581	557	534	510	487	464	440	417	394	370	347	
2	530	507	484	460	437	414	390	367	344	320	297	274	250	
3	434	410	387	364	340	317	294	270	247	223	200	177	153	
4	337	313	290	267	243	220	197	173	150	127	103	80	57	
5	240	217	193	170	147	123	100	77	53	30	6			
6	143	120	97	73	50	26	3							
7	91	67	43	19										
8	48	23												
9	4													

NOTE

- h_0 : Installation height, height measured from the bottom of the casing to the floor
- For intermediate $A_{\text{room A}}$ values, the value that corresponds to the lower $A_{\text{room A}}$ value from the table is considered.
(If $A_{\text{room A}} = 10.5 \text{ m}^2$, consider the value that corresponds to $A_{\text{room A}} = 10 \text{ m}^2$.)
- For intermediate m_c values, the value that corresponds to the higher m_c value from the table is considered. (If $m_c = 2.15 \text{ kg}$, the value that corresponds to $m_c = 2.2 \text{ kg}$ is considered.)

Electrical Wiring

Two kind of cables should be connected to the outdoor unit : One is 'Power cable', the other one is 'Connecting cable'. Power cable is a cable which is used to supply external electricity to the outdoor unit. This cable is generally connected between external power source (such as main electric power distribution panel of user's house) and the outdoor unit. Connecting cable is, on the other hand, used to connect between the outdoor unit and the indoor unit to supply electric power to the indoor unit and to establish the communication between the outdoor unit and the indoor unit.

Procedure for wiring to the outdoor unit is four steps. Before starting wiring, check if wire specification is suitable and read following directions and cautions VERY carefully.



CAUTION

The power cord connected to the outdoor unit should be complied with IEC 60245 or HD 22.4 S4 (This equipment shall be provided with a cord set complying with the national regulation.)

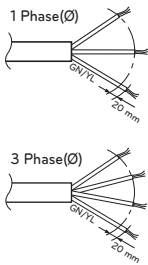

NORMAL CROSS-SECTIONAL AREA

Model Name		Area (mm ²)	Cable Type
Phase (Ø)	Capacity (kW)		
1	5	4	H07RN-F
	7		
	9		
	12	6	
	14		
3	16	2.5	
	12		
	14		
	16		

The connecting cable connected to the outdoor unit should be complied with IEC 60245 or HD 22.4 S4 (This equipment shall be provided with a cord set complying with the national regulation.)

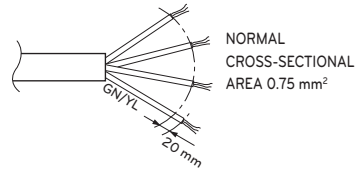

When the connection line between the indoor unit and outdoor unit is over 40 m, connect the telecommunication line and power line separately.

In order to avoid a hazard due to inadvertent resetting of the thermal cut-out, this appliance must not be supplied through an external switching device, such as a timer, or connected to a circuit that is regularly switched on and off by the utility.

If the supply cord is damaged, it must be replaced by the manufacturer, its service agent or similarly qualified persons in order to avoid a hazard.

Precautions when laying power wiring

Use round pressure terminals for connections to the power terminal block.

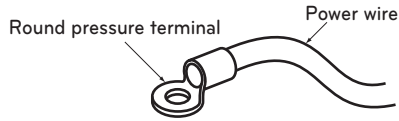

When none are available, follow the instructions below.

- Do not connect wiring of different thicknesses to the power terminal block. (Slack in the power wiring may cause abnormal heat.)
- When connecting wiring which is the same thickness, do as shown in the figure below.

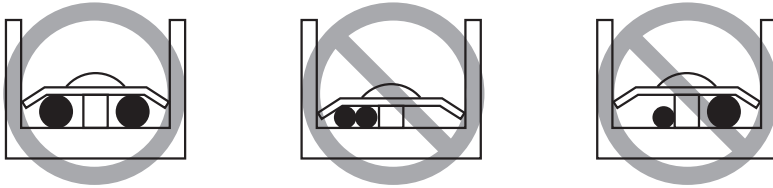

- For wiring, use the designated power wire and connect firmly, then secure to prevent outside pressure being exerted on the terminal block.
- Use an appropriate screwdriver for tightening the terminal screws. A screwdriver with a small head will strip the head and make proper tightening impossible.
- Over-tightening the terminal screws may break them.

! WARNING

Make sure that the screws of the terminal are free from looseness.

Point for attention regarding quality of the public electric power supply

- European/International Technical Standard setting the limits for voltage changes, voltage fluctuations and flicker in public low-voltage supply systems for equipment with rated current ≤ 75 A.
- European/International Technical Standard setting the limits for harmonic currents produced by equipment connected to public low-voltage systems with input current ≤ 16 A of > 75 A per phase.

R410A Split 3 series**For 1 Phase (5, 7, 9 kW)**

This equipment complies with IEC (EN) 61000-3-12 in harmonic currents emission limits corresponding $R_{sce} = 33$.

This device is intended for the connection to a power supply system with a maximum permissible system impedance Z_{MAX} of $0.3410(0.289+j0.181) \Omega$ at the interface point (power service box) of the user's supply. The user has to ensure that this device is connected only to a power supply system which fulfills the requirement above. If necessary, the user can ask the public power supply company for the system impedance at the interface point.

For 1 Phase (12, 14, 16 kW)

This equipment complies with IEC (EN) 61000-3-12 in harmonic currents emission limits corresponding $R_{sce} = 33$.

This device is intended for the connection to a power supply system with a maximum permissible system impedance Z_{MAX} of 0.3138Ω at the interface point (power service box) of the user's supply. The user has to ensure that this device is connected only to a power supply system which fulfills the requirement above. If necessary, the user can ask the public power supply company for the system impedance at the interface point.

For 3 Phase (12, 14, 16 kW)

This equipment complies with IEC (EN) 61000-3-12 provided that the short-circuit power S_{sc} is greater than or equal to 1421 kVA at the interface point between the user's supply and the public system. It is the responsibility of the installer or user of the equipment to ensure, by consultation with the distribution network operator if necessary, that the equipment is connected only to a supply with a short-circuit power S_{sc} greater than or equal to 1421 kVA.

This equipment complies with IEC (EN) 61000-3-3.

R410A Split 4 series

For 1 Phase (12, 14, 16 kW)

This equipment complies with IEC (EN) 61000-3-12 in harmonic currents emission limits corresponding $R_{sce} = 33$.

This device is intended for the connection to a power supply system with a maximum permissible system impedance Z_{MAX} of 0.3268Ω at the interface point (power service box) of the user's supply. The user has to ensure that this device is connected only to a power supply system which fulfills the requirement above. If necessary, the user can ask the public power supply company for the system impedance at the interface point.

For 3 Phase (12, 14, 16 kW)

This equipment complies with IEC (EN) 61000-3-12 provided that the short-circuit power S_{sc} is greater than or equal to 2088 kVA at the interface point between the user's supply and the public system. It is the responsibility of the installer or user of the equipment to ensure, by consultation with the distribution network operator if necessary, that the equipment is connected only to a supply with a short-circuit power S_{sc} greater than or equal to 2088 kVA.

This equipment complies with IEC (EN) 61000-3-3.

R32 Split

For 1 Phase (5, 7, 9 kW)

This equipment complies with IEC (EN) 61000-3-12 in harmonic currents emission limits corresponding $R_{sce} = 33$.

This device is intended for the connection to a power supply system with a maximum permissible system impedance Z_{MAX} of 0.4305Ω at the interface point (power service box) of the user's supply. The user has to ensure that this device is connected only to a power supply system which fulfills the requirement above. If necessary, the user can ask the public power supply company for the system impedance at the interface point.

Hydrosplit

For 1 Phase (12, 14, 16 kW)

This equipment complies with IEC (EN) 61000-3-12 in harmonic currents emission limits corresponding $R_{sce} = 33$.

This equipment complies with reference impedance for IEC (EN) 61000-3-11.

For 3 Phase (12, 14, 16 kW)

This equipment complies with IEC (EN) 61000-3-12 provided that the short-circuit power S_{sc} is greater than or equal to 1959 kVA at the interface point between the user's supply and the public system. It is the responsibility of the installer or user of the equipment to ensure, by consultation with the distribution network operator if necessary, that the equipment is connected only to a supply with a short-circuit power S_{sc} greater than or equal to 1959 kVA.

This equipment complies with IEC (EN) 61000-3-3.

Circuit Breaker Specification

Perform the electrical wiring work according to the electrical wiring connection.

- All wiring must comply with local requirements.
- Select a power source that is capable of supplying the current required by the unit.
- Use a recognized ELCB(Electric Leakage Circuit Breaker) between the power source and the unit. A disconnection device to adequately disconnect all supply lines must be fitted.
- Model of circuit breaker recommended by authorized personnel only

*Pipes and wires should be purchased separately for installation of the product.

Heat Pump							Backup Heater				
Type	Refrigerant	Indoor Unit Series	Phase [Ø]	Capacity [kW]	Power Supply	Outdoor Unit ELCB [A]	Phase [Ø]	Capacity [kW]	Power Supply	Area [mm ²]	ELCB [A]
Split	R32	4	1	5 / 7 / 9	220-240 V~50 Hz	16 / 20 / 25	1	6 (3+3)	220-240 V~50 Hz	4	40
		5									
	R410A	3	1	5 / 7 / 9	220-240 V~50 Hz	30	1	6 (3+3)	220-240 V~50 Hz	4	40
			1	12 / 14 / 16		40	1	6 (3+3)		6	40
		3	12 / 14 / 16	380-415 V~50 Hz	20	3	9 (3+3+3)	380-415 V~50 Hz	2.5	32	
		5	1	12 / 14 / 16	220-240 V~50 Hz	40	1	6 (3+3)	220-240 V~50 Hz	6	40
3	12 / 14 / 16		380-415 V~50 Hz	20	3	6 (2+2+2)	380-415 V~50 Hz	2.5	32		
Hydrosplit	R32	0	1	12 / 14 / 16	220-240 V~50 Hz	40	1	-	-	-	-
			3	12 / 14 / 16	380-415 V~50 Hz	16	3	-	-	-	-

- Power Supply for Heat Pump

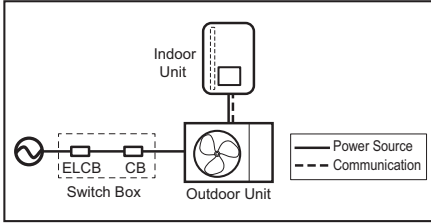

- Power Supply for Backup Heater

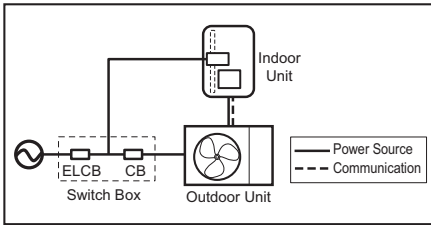

- Power Supply for DHW Booster Heater

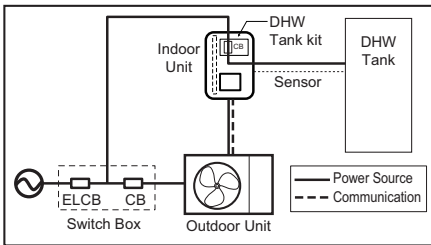

PIPING AND WIRING FOR OUTDOOR UNIT

Procedures about refrigerant piping and electric wiring at the outdoor are described in this chapter. Most of procedures are similar to those of LG Air Conditioner.

*Pipes and wires should be purchased separately for installation of the product.

(For Split)

*In the case of Hydrosplit Model, there is no refrigerant piping

Refrigerant Piping

Before starting refrigerant piping, constraints in pipe length and elevation should be examined. After resolving all constraints, some preparations are required to proceed. Then connecting pipe to the outdoor and the indoor unit is beginning.

Constraints in Pipe Length and Elevation

Refrigerant	Capacity (kW)	Pipe Diameter [mm(inch)]		Length A (m)		Elevation B (m)	Additional Refrigerant (g/m)
		Gas	Liquid	Standard	Max.	Max.	
R410A	5/7/9/12/ 14/16	15.88(5/8")	9.52(3/8")	7.5	50	30	40
R32	5/7/9	15.88(5/8")	9.52(3/8")	5	50	30	40

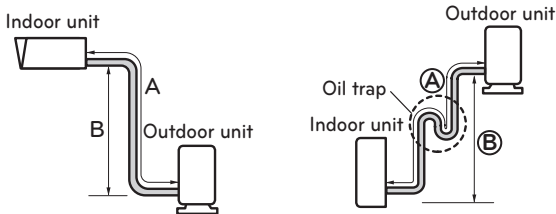

A trap is necessary when the outdoor unit is installed in a higher position than the indoor unit.

CAUTION

- For R410A products, If the pipe length is longer than 7.5 m, additional charge of the refrigerant is required according to the table.
 - Example : If 16 kW model is installed at a distance of 50 m, 1 700 g of refrigerant should be added according to following formula : $(50-7.5) \times 40 \text{ g} = 1\,700 \text{ g}$
- For R32 products, If the pipe length is longer than 10 m, additional charge of the refrigerant is required according to the table.
 - Example : If R32 9 kW model is installed at a distance of 50 m, 1 600 g of refrigerant should be added according to following formula : $(50-10) \times 40 \text{ g} = 1\,600 \text{ g}$
- Rated capacity of the product is based on standard length and maximum allowable length is based on the product reliability in the operation.
- Improper refrigerant charge may result in abnormal operation.
- Oil trap should be installed every 10 meters, when the outdoor unit is installed in a higher position than the indoor unit.

NOTE

Fill in the f-gas Label attached on outdoor about the quantity of the fluorinated greenhouse gases (This note about f-gas label may not apply depending on your product type or market.)

- Manufacturing site (See Model Name label)
- Installation site (If possible being placed adjacent to the service points for the addition or removal of refrigerant)
- The total Charge (① + ②)

Preparation for Piping

- Main cause of gas leakage is defect in flaring work. Carry out correct flaring work in the following procedure.
- Use the de-oxidised copper as piping materials to install.

Step 1. Cut the pipes and the cable.

- Use the accessory piping kit or the pipes purchased locally.
- Measure the distance between the indoor unit and the outdoor unit.
- Cut the pipes a little longer than measured distance.
- Cut the cable 1.5 m longer than the pipe length.

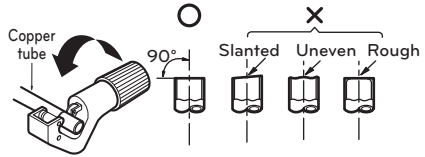

Step 2. Burrs removal

- Completely remove all burrs from the cut cross section of pipe/tube.
- Put the end of the copper tube/pipe to downward direction as you remove burrs in order to avoid to let burrs drop in the tubing.

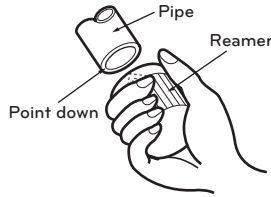

Step 3. Putting nut on

- Remove flare nuts attached to indoor and outdoor units, then put them on pipe/tube having completed burr removal. (Not possible to put them on after flaring work)

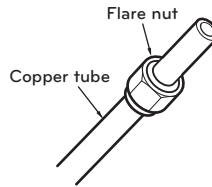

Step 4. Flaring work.

- Carry out flaring work using dedicated flaring tool for R-410A refrigerant as shown below.

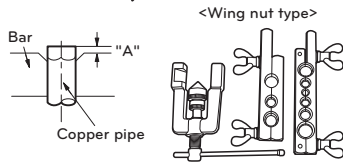

Pipe diameter [inch(mm)]	A inch (mm)		Clutch type
	Wing nut type	Clutch type	
1/4 (6.35)	0.04~0.05(1.1~1.3)	0~0.02 (0~0.5)	
3/8 (9.52)	0.06~0.07(1.5~1.7)		
1/2 (12.7)	0.06~0.07(1.6~1.8)		
5/8 (15.88)	0.06~0.07(1.6~1.8)		
3/4 (19.05)	0.07~0.08(1.9~2.1)		

<Clutch type>

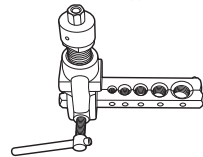

- Firmly hold copper tube in a bar(or die) as indicated dimension in the table above.

Step 5. Check

- Compare the flared work with right figure.
- If flare is seemed to be defective, cut off the flared section and do flaring work again.

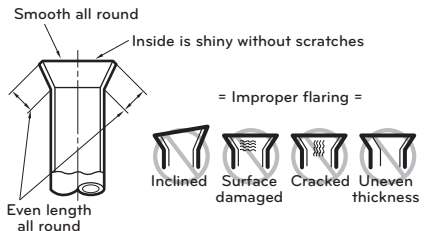

Connecting Pipe to Indoor Unit

Connecting pipe to the indoor unit is two steps. Read following directions carefully.

Step 1. Pre-tightening.

- Align the center of the pipes and sufficiently tighten the flare nut by hand.

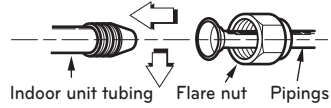

Step 2. Tightening.

- Tighten the flare nut with a wrench.
- Tightening torque is as following.

Outside diameter [mm(inch)]	Torque [kgf·m]
6.35 (1/4)	1.8 ~ 2.5
9.52 (3/8)	3.4 ~ 4.2
12.7 (1/2)	5.5 ~ 6.6
15.88 (5/8)	6.6 ~ 8.2
19.05 (3/4)	9.9 ~ 12.1

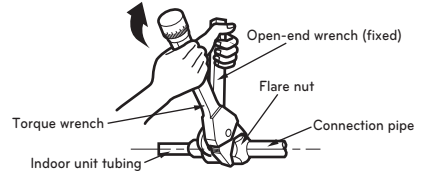

Connecting Pipe to Outdoor Unit

Connecting pipe to the outdoor unit is five steps including PCB setting.

Step 1. Determine direction of pipes.

- The pipes can be connectable in three directions.
- The directions are expressed in below figure.
- When connecting in a downward direction, knock out the knock-out hole of the base pan.
- Detailed geometry may vary by model.

Product Heating Capacity : 5 kW, 7 kW, 9 kW

Product Heating Capacity : 12 kW, 14 kW, 16 kW

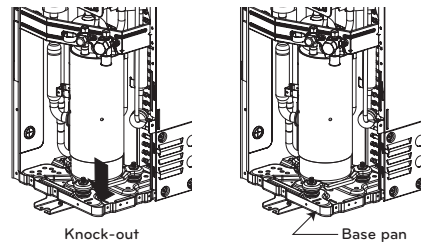
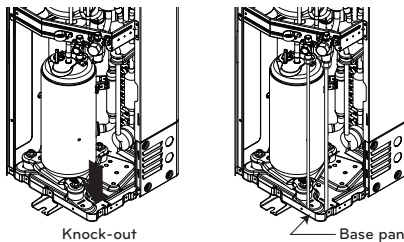
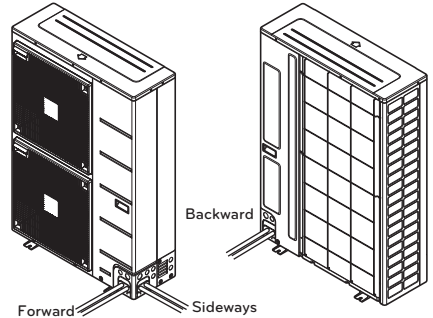
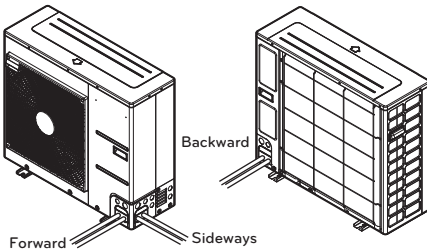

Step 2. Tightening

- Align the center of the pipes and sufficiently tighten the flare nut by hand.
- Tighten the flare nut with a wrench until the wrench clicks.
- Tightening torque is as following.

Outside diameter [mm(inch)]	Torque [kgf·m]
6.35 (1/4)	1.8 ~ 2.5
9.52 (3/8)	3.4 ~ 4.2
12.7 (1/2)	5.5 ~ 6.6
15.88 (5/8)	6.6 ~ 8.2
19.05 (3/4)	9.9 ~ 12.1

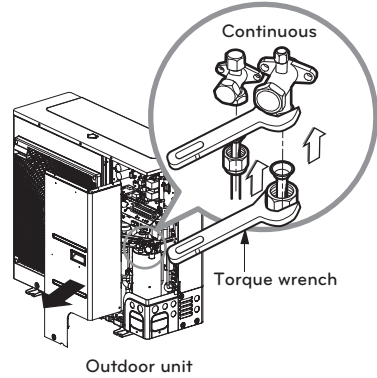

Step 3. Preventing entering of foreign objects

- Plug the pipe through-holes with putty or insulation material (procured locally) to fill up all gaps as shown in right figure.
- If insects or small animals enter the outdoor unit, it may cause a short circuit in the electrical box.
- Finally, form the pipes by wrapping the connecting portion of the indoor unit with insulation material and secure it with two kinds of vinyl tape. Ensuring thermal insulation is very important.

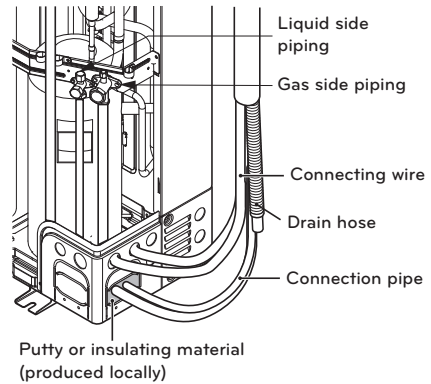

Wiring Procedure for Power Cable and Connecting Cable

Step 1. : Disassemble the side panel from the outdoor unit by loosening screws.

Step 2. : Connect Power cable to Main Power Terminal and Connecting cable to Control Terminal, respectively. See below figure for detailed information. When connecting earth cable, the diameter of cable should be bigger than 1.6 mm² to secure safety. The earth cable is connected to the terminal block where earth symbol \oplus is marked.

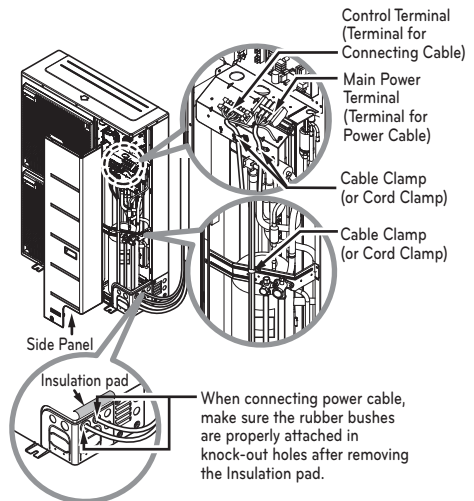

(For R410A Split)

Step 3 : Use cable clamps (or cord clamps) to prevent unintended move of Power cable and Connecting cable.

Step 4 : Reassemble the side panel to the outdoor unit by fastening screws.

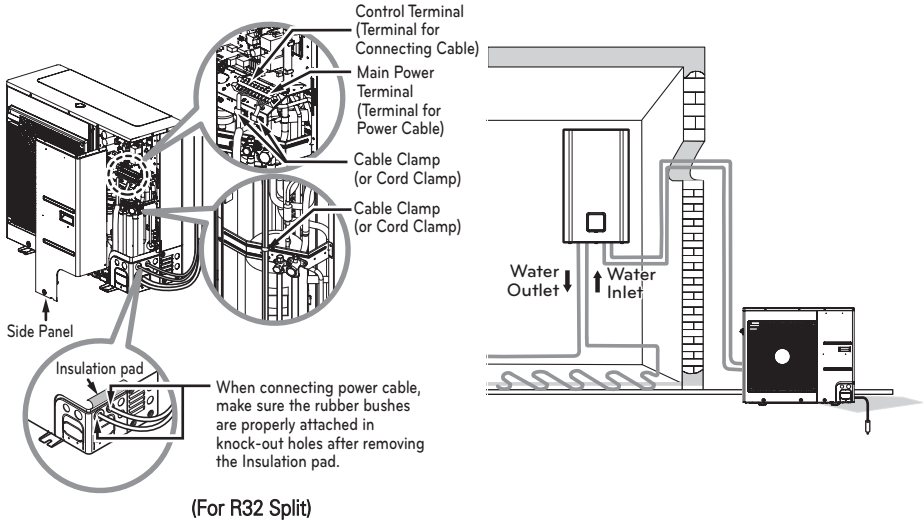

⚠ CAUTION

After checking and confirming following conditions, start wiring work.

- Secure dedicated power source for the Air-to-Water heat pump. The wiring diagram (attached inside the control box of the indoor unit) is presenting related information.
- Provide a circuit breaker switch between power source and the outdoor unit.
- Although it is very rare case, sometimes the screws used to fasten internal wires can be loosen due to the vibration while product transportation. Check these screws and make it sure if they are all fastened tightly. If not tightened, burn-out of the wire can be occurred.
- Check the specification of power source such as phase, voltage, frequency, etc.
- Confirm that electrical capacity is sufficient.
- Be sure that the starting voltage is maintained at more than 90 percent of the rated voltage marked on the name plate.
- Confirm that the cable thickness is as specified in the power sources specification. (Particularly note the relation between cable length and thickness.)
- Provide an ELB(electric leakage breaker) when the installation place is wet or moist.
- The following troubles would be caused by abnormal voltage supply such as sudden voltage increasing or voltage drop-down.
 - Chattering of a magnetic switch. (frequent on and off operation.)
 - Physical damage of parts where magnetic switch is contacted.
 - Break of fuse.
 - Malfunction of overload protection parts or related control algorithms.
 - Failure of compressor start up.
- Ground wire to ground outdoor unit to prevent electrical shock.

CAUTION

The Power cord connected to the unit should be selected according to the following specifications.

Finalizing

After pipes are connected and electric cables are wired, pipe forming and some tests are remained. Especially, careful attention is required while proceeding leakage test because the leakage of the refrigerant effects degrade of performance directly. Also, it is very hard to find leaked point after all installation procedures are finished.

Pipe Forming

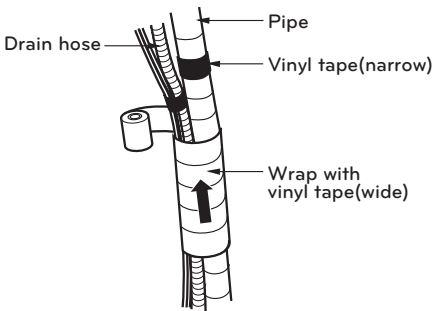

Do pipe forming by wrapping the connecting cable and refrigerant pipe (between the indoor unit and outdoor unit) with thermal insulation material and secure it with two kinds of vinyl tape.

- Tape the refrigerant pipe, power cable and connecting cable from down to up.
- Secure the taped pipe is along with the exterior wall. Form a trap to prevent water entering the room and electrical part.
- Fix the taped pipe onto the wall by saddle or equivalent.

Taping Procedure

- Tape the pipes, connecting cable and power cable from down to up. If taping direction is up to down, rain drop may be sinking into the pipes or cables.
- Secure the taped pipe along the exterior wall using saddle or equivalent.
- Trap is required to prevent water from entering into electrical parts.

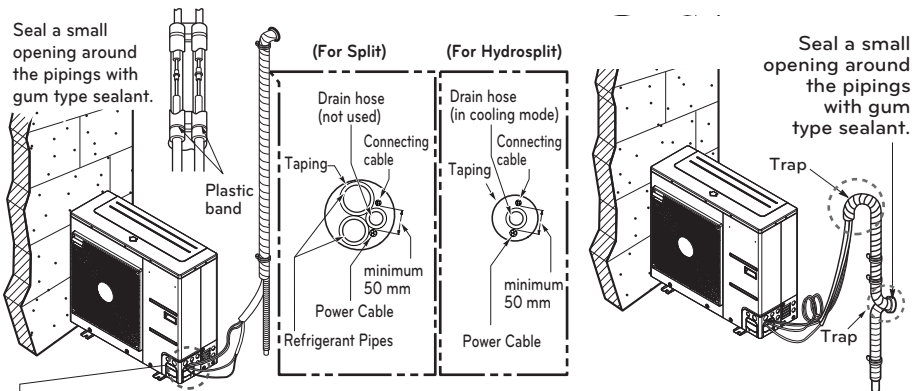

- Trap is required to prevent water from entering into electrical parts.

Leakage test and Evacuation

Air and moisture remaining in the refrigerant system have undesirable effects as indicated below.

- Pressure in the system rises.
- Operating current rises.
- Cooling(or heating) efficiency drops.
- Moisture in the refrigerant circuit may freeze and block capillary tubing.
- Water may lead to corrosion of parts in the refrigeration system.

Therefore, the indoor/outdoor unit and connecting tube must be checked for leak tight, and vacuumed to remove incondensable gas and moisture in the system.

Preparation

- Check that each tube(both liquid and gas side tubes) between the indoor and outdoor units have been properly connected and all wiring for the test run has been completed. Remove the service valve caps from both the gas and the liquid side on the outdoor unit. Check that both the liquid and the gas side service valves on the outdoor unit are kept closed at this stage.

Leakage test

- Connect the manifold valve(with pressure gauges) and dry nitrogen gas cylinder to this service port with charge hoses.

CAUTION

Be sure to use a manifold valve for leakage test. If it is not available, use a stop valve for this purpose. The "Hi" knob of the manifold valve must always be kept close.

- Pressurize the system to no more than 3.0 MPa with dry nitrogen gas and close the cylinder valve when the gauge reading reached 3.0 MPa Next, test for leaks with liquid soap.

To avoid nitrogen entering the refrigerant system in a liquid state, the top of the cylinder must be higher than its bottom when you pressurize the system. Usually, the cylinder is used in a vertical standing position.

- Do a leakage test of all joints of the tubing(both indoor and outdoor) and both gas and liquid side service valves. Bubbles indicate a leak. Be sure to wipe off the soap with a clean cloth
- After the system is found to be free of leaks, relieve the nitrogen pressure by loosening the charge hose connector at the nitrogen cylinder. When the system pressure is reduced to normal, disconnect the hose from the cylinder.

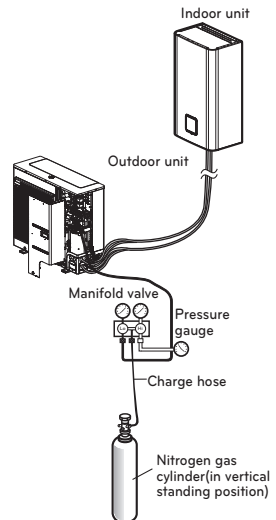

Evacuation

- Connect the charge hose end described in the preceding steps to the vacuum pump to evacuate the tubing and indoor unit. Confirm the "Lo and Hi" knob of the manifold valve is open. Then, run the vacuum pump. The operation time for evacuation varies with tubing length and capacity of the pump. The following table shows the time required for evacuation.

Required time for evacuation when 30 gal/h vacuum pump is used	
If tubing length is less than 10 m(33 ft)	If tubing length is longer than 10 m(33 ft)
30 min. or more	60 min. or more
0.8 torr or less	

- When the desired vacuum is reached, close the "Lo and Hi" knob of the manifold valve and stop the vacuum pump.

Finishing the job

- With a service valve wrench, turn the valve stem of liquid side valve counter-clockwise to fully open the valve.
- Turn the valve stem of gas side valve counter-clockwise to fully open the valve.
- Loosen the charge hose connected to the gas side service port slightly to release the pressure, then remove the hose.
- Replace the flare nut and its bonnet on the gas side service port and fasten the flare nut securely with an adjustable wrench. This process is very important to prevent leakage from the system.
- Replace the valve caps at both gas and liquid side service valves. This completes air purging with a vacuum pump.

THERMAV. is now ready to test run.

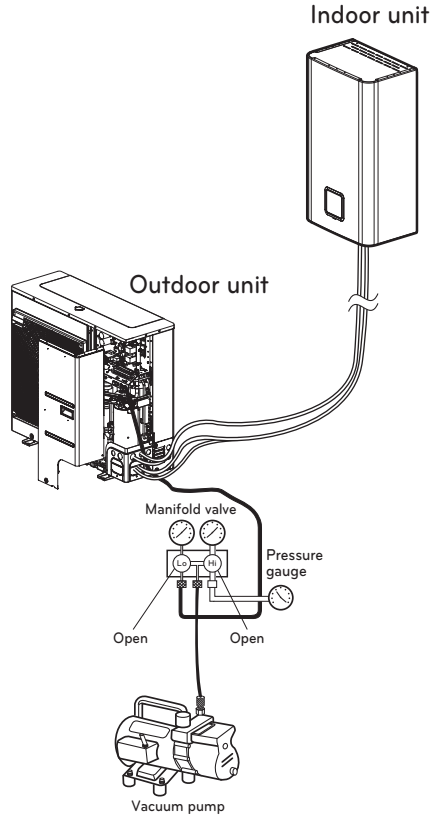

Wiring Procedure for Power Cable and Connecting Cable

(For Hydrosplit)

This cable is generally connected between external power source (such as main electric power distribution panel of user's house) and the unit. Before starting wiring, check if wire specification is suitable and read following directions and cautions VERY carefully.

Step 1. : Disassemble side panel and front panel from the unit by loosening screws.

- 1Ø

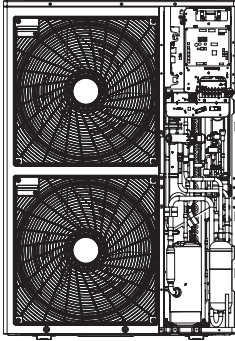

- 3Ø

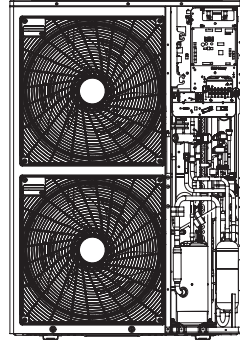

Step 2. : Connect power cable to main power terminal
 See below figure for detailed information. When connecting earth cable, the diameter of cable should refer to the below table. The earth cable is connected to the Control box case where earth symbol is \oplus marked.

Step 3. : Use cable clamps (or cord clamps) to prevent unintended move of power cable.

Step 4. : Reassemble the side panel to the unit by fastening screws.

- 1Ø

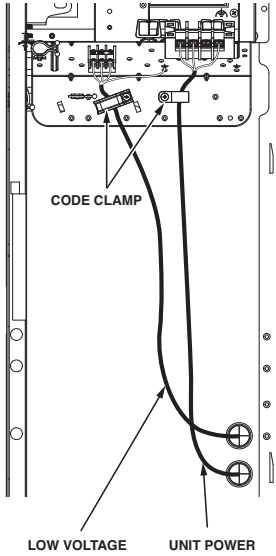

- 3Ø

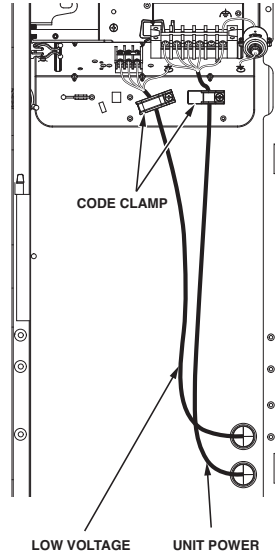

Failure to do these instruction can result in fire, electric shock or death.

- Make sure the power cable do not touch to copper tube.
- Make sure to fix [cord clamp] firmly to sustain the connection of terminal.
- Make sure to connect unit power & heater power separately.

Electrical Wiring

General Consideration

Followings are should be considered before beginning indoor unit wiring.

- Field-supplied electrical components such as power switches, circuit breakers, wires, terminal boxes, etc should be properly chosen with compliance with national electrical legislation or regulation.
- Make it sure that supplied electricity is enough to operate the product including outdoor unit, electric heater, water tank heater, etc. The capacity of fuse also selected according to the power consumption.
- The main electricity supply should be dedicated line. Sharing main electricity supply with other devices such as washing machine or vacuum cleaner is not permitted.

CAUTION

- Before starting wiring job, the main electricity supply should be turned off until wiring is completed.
- When adjusting or changing wiring, the main electricity supply should be turned off and ground wire should be connected securely.
- Installation place should be free from the attack of wild animal. For example, mice's wire attacking or frog's entering into the indoor unit may cause critical electrical accident.
- All power connections should be protected from dew condensation by thermal insulation.
- All electrical wiring should comply with national or local electrical legislation or regulation.
- The ground should be connected exactly. Do not earth the product to the copper pipe, steel fence at the veranda, city water outlet pipe, or any other conductivity materials.
- Fix all cable using cord clamp tightly. (When cable is not fixed with cord clamp, use additionally supplied cable ties.)

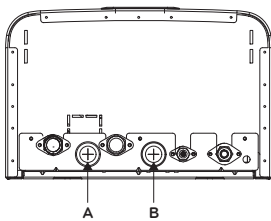

(For Split)

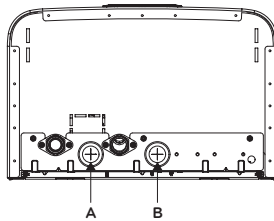

(For Hydrosplit)

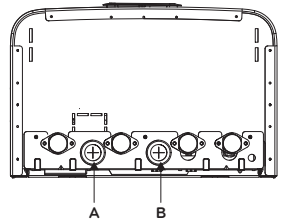

Hole A : For DC line (wire which is connected to the PCB of the control box)

Hole B : For AC line (wire which is connected to the terminal block of the control box)

Terminal Block Information

(For Split R32 Indoor unit 4 Series, For Split R410A Indoor unit 3 Series)

Symbols used below pictures are as follows :

- L, L1, L2 : Live (230 V AC)
- N : Neutral (230 V AC)
- BR : Brown, WH : White, BL : Blue, BK : Black

Terminal Block 1

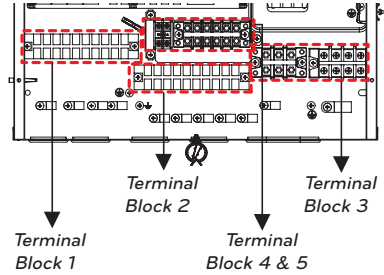
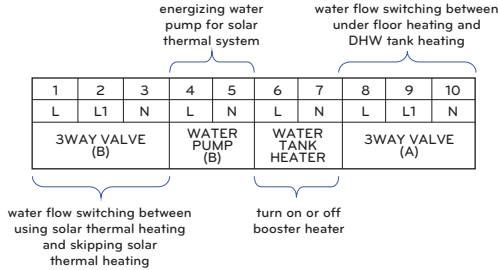

Terminal Block 2

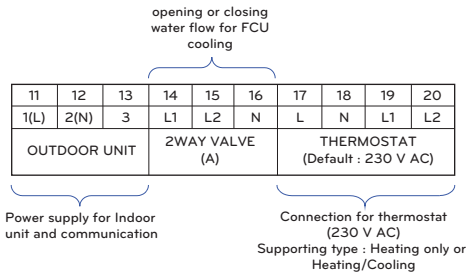

Terminal Block 3 (1Ø Backup Heater)

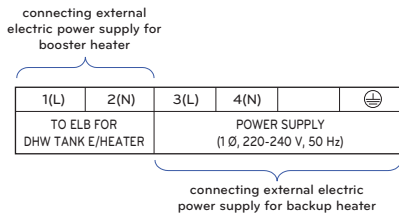

Terminal Block 3 (3Ø Backup Heater)

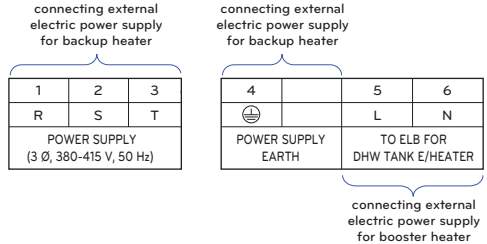

Terminal Block 4 & 5

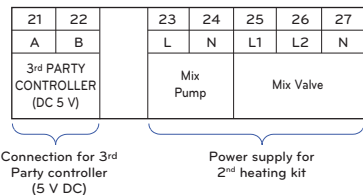

Terminal Block Information

(For Split Indoor unit 5 series, Hydrosplit 2-Pipe)

Symbols used below pictures are as follows :

- L, L1, L2 : Live (230 V AC)
- N : Neutral (230 V AC)
- BR : Brown, WH : White, BL : Blue, BK : Black

For 1Ø

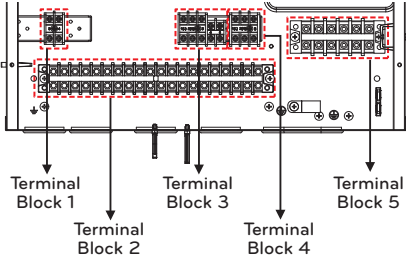

For 3Ø

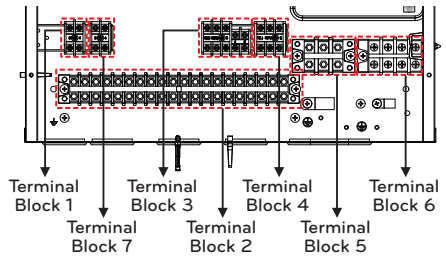

Terminal Block 1 ~ 4

Connection for 3rd Party controller (5 V DC)

21	22
A	B

3rd PARTY CONTROLLER (5V DC)

Connection for thermostat (230 V AC)
Supporting type : Heating only or Heating/Cooling

23	24	25	26	27
L	N	L1	L2	L3

THERMOSTAT (Default : 230 V AC)

Water flow switching between using solar thermal heating and skipping solar thermal heating

18	19	20
L	L1	N

3WAY VALVE (B)

1	2	3	4	5	6	7	8	9	10	11	12	13	14	15	16	17	18	19	20
L	N	L	N	L	N	L	N	L1	L2	N	L	L1	N	L1	L2	N	1(L)	2(N)	3
WATER TANK HEATER		WATER PUMP (C)		WATER PUMP (B)		MIX PUMP		MIX VALVE		3WAY VALVE (A)			2WAY VALVE (A)		OUTDOOR UNIT				
Turn on or off booster heater		Energizing water pump for DHW-recirculation		Energizing water pump for solar thermal system		Power supply for 2nd heating kit				Water flow switching between under floor heating and DHW tank heating			Opening or closing water flow for FCU cooling		Power supply for Indoor unit and communication				

Terminal Block 5 (For 1Ø)

TO ELB FOR DHW TANK E/HEATER	POWER SUPPLY (1 Ø, 220-240 V, 50 Hz)
------------------------------	--------------------------------------

connecting external electric power supply for booster heater

connecting external electric power supply for backup heater

Terminal Block 5 (For 3Ø)

R	S	T
---	---	---

POWER SUPPLY (3 Ø, 380-415 V, 50 Hz)

connecting external electric power supply for backup heater

Terminal Block 6 (For 3Ø)

⊕		L	N
POWER SUPPLY EARTH		TO ELB FOR DHW TANK E/HEATER	

Connecting external electric power supply for backup heater

Connecting external electric power supply for backup heater

Terminal Block Information

(For Hydrosplit 1-Pipe)

Symbols used below pictures are as follows :

- L, L1, L2, L3 : Live (230 V AC)
- N : Neutral (230 V AC)
- BR : Brown, WH : White, BL : Blue, BK : Black

Terminal Block 1

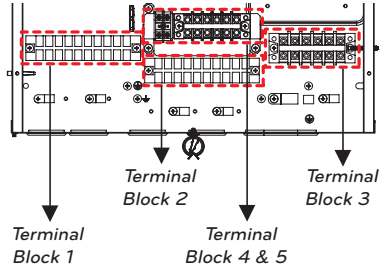
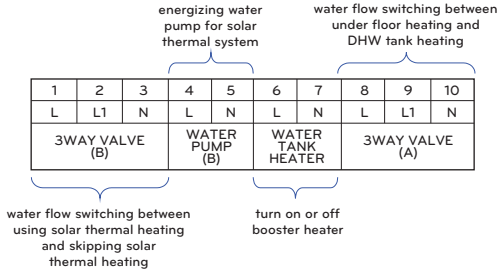

Terminal Block 2

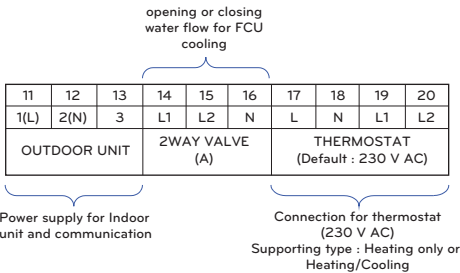

Terminal Block 3 (1Ø Backup Heater)

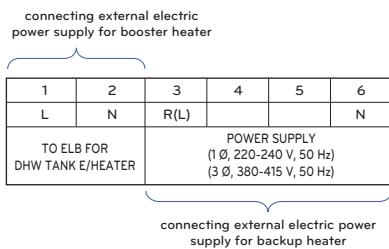

Terminal Block 3 (3Ø Backup Heater)

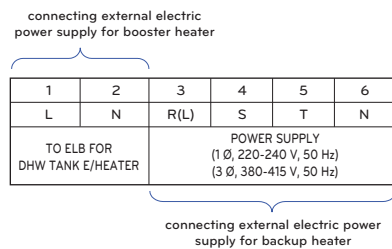

Terminal Block 4 & 5

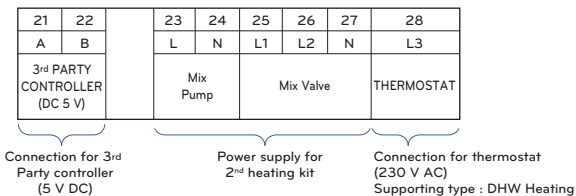

CAUTION

You should separate the communication wiring, in case of communication wiring length is over 40 M.

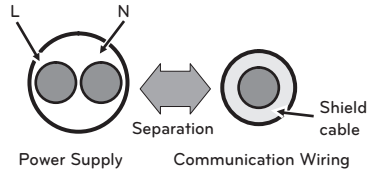

Connecting with Outdoor Unit

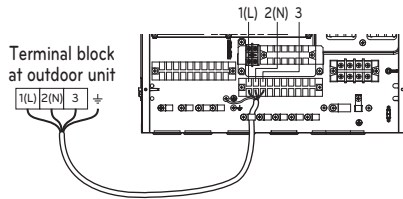

(For Split R410A Indoor unit 3 Series, For Split R32 Indoor unit 4 Series)

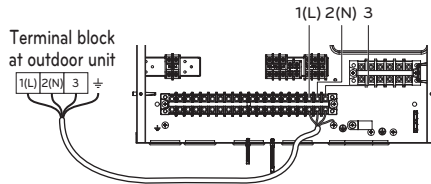

(For Split Indoor unit 5 Series)

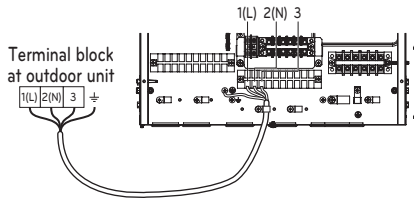

(For Hydrosplit)

The feature may be changed according to the type of model.

Backup Heater Wiring

CAUTION

Power Cable Specification : The power cord connected to the outdoor unit should be complied with IEC 60245 or HD 22.4 S4(Rubber insulated cord, type 60245 IEC 66 or H07RN-F)

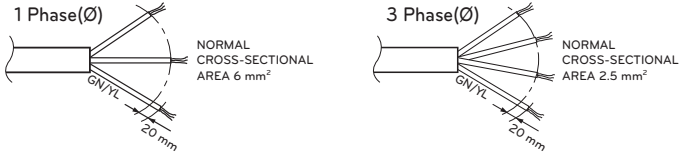

If the supply cord is damaged, it must be replaced by the manufacturer, its service agent or similarly qualified persons in order to avoid a hazard.

External power supply
(same dedicated power supply for the indoor unit and outdoor unit)

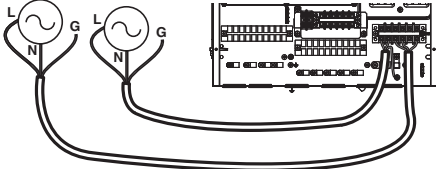

1 \emptyset Backup Heater
(For Split R410A Indoor unit 3 Series)

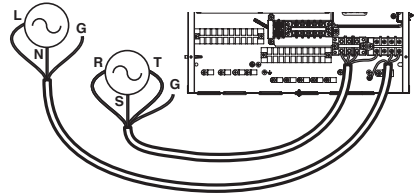

3 \emptyset Backup Heater
(For Split R410A Indoor unit 3 Series)

External power supply
(same dedicated power supply for the indoor unit and outdoor unit)

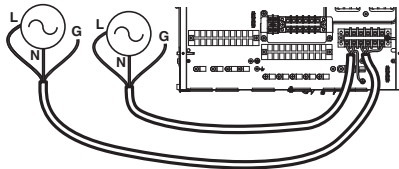

1 \emptyset Backup Heater
(For Split R32 Indoor unit 4 Series)

! CAUTION

External power supply
(same dedicated power
supply for the indoor
unit and outdoor unit)

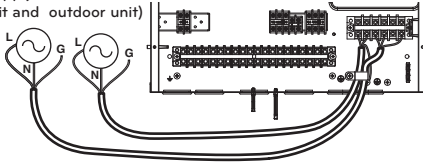

1Ø Backup Heater
(For Split R410A Indoor unit 5 Series,
For Split R32 Indoor unit 5 Series)

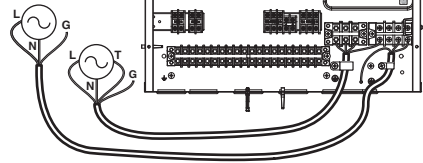

3Ø Backup Heater
(For Split R410A Indoor unit 5 Series)

External power supply
(same dedicated power
supply for the indoor
unit and outdoor unit)

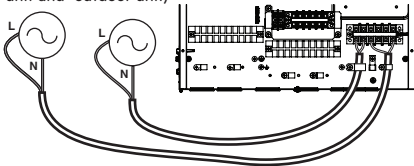

1Ø Backup Heater
(For Hydrosplit)

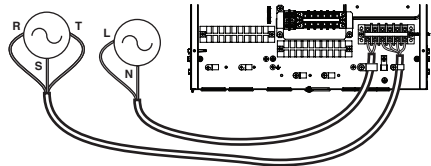

3Ø Backup Heater
(For Hydrosplit)

PIPING AND WIRING FOR INDOOR UNIT

Procedures about water piping and electric wiring at the indoor unit are described in this chapter. Water piping and water circuit connection, water charging, pipe insulations will be shown for water piping procedures. For wiring, terminal block connection, connecting with the outdoor unit, electric heater wiring will be introduced. Accessories connection, such as sanitary water tank, thermostat, 3way or 2way valves, etc will be dealt in separated chapter.

Water Piping and Water Circuit Connection

⚠ CAUTION

General Considerations

Followings are should be considered before beginning water circuit connection.

- Service space should be secured.
- Water pipes and connections should be cleaned using water.
- Space for installing external water pump should be provided if internal water pump capacity is not enough for installation field.
- Never connect electric power while proceeding water charging.

Definition of terms are as follow :

- Water piping : Installing pipes where water is flowing inside the pipe.
- Water circuit connecting : Making connection between the product and water pipes or between pipes and pipes. Connecting valves or elbows are, for example, in this category.

Configuration of water circuit is shown in Chapter 2. All connections should be complied with presented diagram.

While installing water pipes, followings should be considered :

- While inserting or putting water pipes, close the end of the pipe with pipe cap to avoid dust entering.
- When cutting or welding the pipe, always be careful that inner section of the pipe should not be defective. For example, no weldments or no burrs are found inside the pipe.
- Drain piping should be provided in case of water discharge by the operation of the safety valve. This situation can be happened when the internal pressure is over 3.0 bar and water inside the indoor unit will be discharged to drain hose.

While connecting water pipes, followings should be considered.

- Pipe fittings (e.g. L-shape elbow, T-shape tee, diameter reducer, etc) should be tightened strongly to be free from water leakage.
- Connected sections should be leakage-proof treatment by applying teflon tape, rubber bushing, sealant solution, etc.
- Appropriate tools and tooling methods should be applied to prevent mechanical breakage of the connections.
- Operation time of flow control valve(e.g. 3way valve or 2way valve) should be less than 90 seconds.
- Drain hose should be connected with drain piping.
- Maximum allowable Torque at the water piping connection is 50 N·m

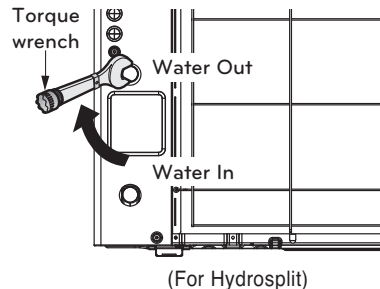

 **WARNING****Installing shut-off valve**

- While assembling two shut-off valves pop sound will be heard when valve is open or close by rotating handles. It is normal condition because the sound is due to leakage of charged nitrogen gas inside the valve. The nitrogen gas is applied to secure quality assurance.
 - For Split R32 Indoor unit 4 Series, For Split R410A Indoor unit 3 Series : LG Supply (Inside 'AWHP Installation Kit')
 - For Split 5 series, Hydrosplit : Field Supply
- Before starting water charging, these two shut-off valves should be assembled with water inlet and outlet pipe of the indoor unit.

Water condensation on the floor

While cooling operation, it is very important to keep leaving water temperature higher than 16 °C. Otherwise, dew condensation can be occurred on the floor.

If floor is in humid environment, do not set leaving water temperature below 18 °C.

Water condensation on the radiator

While cooling operation, cold water may not flow to the radiator. If cold water enters to the radiator, dew generation on the surface of the radiator can be occurred.

Drainage treatment

While cooling operation, condensed dew can drop down to the bottom of the indoor unit. In this case, prepare drainage treatment (for example, vessel to contain condensed dew) to avoid water drop.

Water Charging

For water charging, please follow below procedures.

Step 1. Open all valves of whole water circuit. Supplied water should be charged not only inside the indoor unit, but also in the under floor water circuit, sanitary water tank circuit, FCU water circuit, and any other water circuits controlled by the product.

Step 2. Connect supply water into drain valve and fill valve.

CAUTION

No water-leakage permitted at the drain and fill valve. Leakage-proof treatment which is described in previous section should be applied.

*The configuration of the valve may vary by model type.

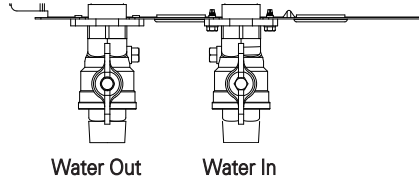

Step 3. Start to supply water. While supplying water, following should be kept.

- Pressure of supplying water should be 2.0 bar approximately.
- For supplying water pressure, time to be taken from 0 bar to 2.0 bar should be more than 1 minute. Sudden water supply can yield water drain through safety valve.
- Fully open the cap of air vent to assure air purging. If air is exist inside the water circuit, then performance degrade, noise at the water pipe, mechanical damage at the surface of electric heater coil.
- Open both the air vent in the water pipe and the air vent in the pump.

Step 4. Stop water supplying when the pressure gauge located in front of the control panel indicates 2.0 bar.

Step 5. Close drain valve and fill valve. Then wait for 20~30 seconds to observe water pressure being stabilized.

Step 6. If following conditions are satisfactory, then go to step 7(pipe insulation). Otherwise, go to step 3.

- Pressure gauge indicates 2.0 bar. Note that sometimes pressure is decreased after step 5 due to water charging inside expansion vessel.
- No air purging sound is heard or no water drop are popping out from air vent.

CAUTION

Keep the air vent of the water pipe open and keep the air vent of the pump closed. Otherwise, the pump may make noise.

Pipe Insulation

Purpose of water pipe insulation is :

- To prevent heat loss to external environment
- To prevent dew generation on the surface of the pipe in cooling operation
- Minimum insulation thickness recommendations ensure correct operation of the product, but local regulations may vary and must be followed.

Water Piping length (m)	Minimum insulation Thickness(mm)
<20	20
20~30	30
30~40	40
40~50	50

* $\lambda = 0.04 \text{ W/mk}$
(Thermal conductivity of pipe insulation)

Water pump Capacity

The water pump is variable type which is capable to change flow rate, so it may be required to change default water pump capacity in case of noise by water flow. In most case, however, it is strongly recommended to set capacity as Maximum.

NOTE

- To secure enough water flow rate, do not set water pump capacity as Minimum. It can lead unexpected flow rate error CH14.

Pressure Drop

NOTE

When installing the product, install additional pump in consideration of the pressure loss and pump performance.
If flow-rate is low, overloading of product can occur.

Model	Capacity [kW]	Rated flow-rate [LPM]	Pump Head [m] (at rated flow-rate)	Product pressure drop [m] (Plate heat exchanger)	Serviceable Head [m]
For Split R410A Indoor unit 3 Series	16	46.0	9.5	1.4	8.1
	14	40.25	10.0	1.1	8.9
	12	34.5	10.7	0.8	9.9
	9	25.87	11.3	0.4	10.9
	7	20.12	11.6	0.3	11.3
	5	15.81	11.8	0.2	11.6
For Split R32	9	25.87	6.1	0.4	5.7
	7	20.12	7.3	0.3	7.0
	5	15.81	7.5	0.2	7.3
For Split R410A Indoor unit 5 Series, For Hydrosplit	16	46.0	9	1.4	7.6
	14	40.25	9.3	1.1	8.2
	12	34.5	9.8	0.8	9

Performance curve

Indoor : Electric Heater 1Ø, Indoor : Electric Heater 3Ø

Pump model : PY-122NDDD3 (For Split R410A Indoor unit 3 Series)

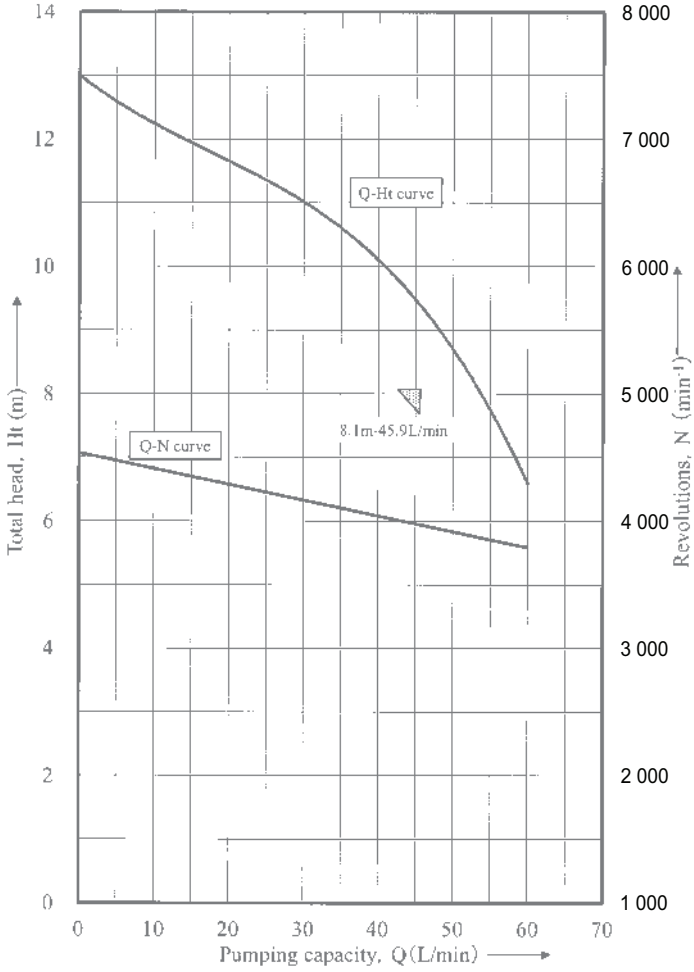

MGQ62321902 : UPM3K GEO 20 - 75 CHBL
 (5 kW, 7 kW, 9 kW / For Split R32)

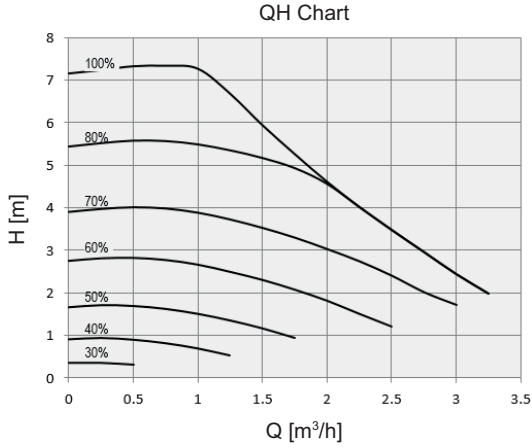

MGQ62321901 : UPML GEO 20-105 CHBL
 (12 kW, 14 kW, 16 kW / For Split R410A Indoor unit 5 Series, For Hydrosplit)

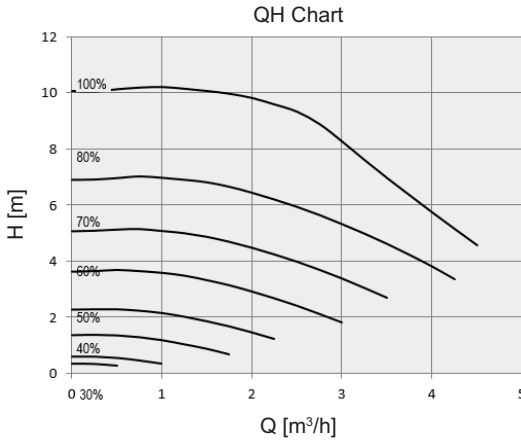

Performance test based on standard ISO 9906 with pre-pressure 2.0bar and liquid temperature 20 °C.



WARNING

Selecting a water flowrate outside the curves can cause damage to or malfunction of the unit.

Water Quality

Water quality should be complied with EN 98/83 EC Directives.
Detailed water quality condition can be found in EN 98/83 EC Directives.

CAUTION

- If the product is installed at existing hydraulic water loop, it is important to clean hydraulic pipes to remove sludge and scale.
- Installing sludge strainer in the water loop is very important to prevent performance degrade.
- Chemical treatment to prevent rust should be performed by installer.
- It is strongly recommended to install an additional filter on the heating water circuit. Especially to remove metallic particles from the heating piping, it is advised to use a magnetic or cyclone filter, which can remove small particles. Small particles may damage the unit and will NOT be removed by the standard filter of the heat pump system.

Frost protection by antifreeze

In areas of the country where entering water temperatures drop below 0 °C, the water pipe must be protected by using an approved antifreeze solution. Consult your AWHP unit supplier for locally approved solutions in your area. Calculate the approximate volume of water in the system. (Except the AWHP unit.) And add six liters to this total volume to allow for the water contained in AWHP unit.

Antifreeze type	Antifreeze mixing ratio					
	0 °C	-5 °C	-10 °C	-15 °C	-20 °C	-25 °C
Ethylene glycol	0 %	12 %	20 %	30 %	-	-
Propylene glycol	0 %	17 %	25 %	33 %	-	-
Methanol	0 %	6 %	12 %	16 %	24 %	30 %

If you use frost protection function, change DIP switch setting and input the temperature condition in Installation mode of remote controller. Refer to 'CONFIGURATION > DIP Switch Setting > DIP Switch Information > Option Switch 3' and 'INSTALLER SETTING > Antifreezing Temperature'.

CAUTION

- Use only one of the above antifreeze.
- If a antifreeze is used, pressure drop and capability degradation of the system can be occurred.
- If one of antifreezes is used, corrosion can be occurred. So please add corrosion inhibitor.
- Please check the concentration of the antifreeze periodically to keep same concentration.
- When the antifreeze is used (for installation or operation), take care to ensure that antifreeze must not be touched.
- Ensure to respect all laws and norms of your country about Anti-freeze usage.

Frost protection by antifreeze valve (For Hydrosplit)

About antifreeze valve

This is a valve to prevent freeze in winter. When no antifreeze is added to the water, you can use antifreeze valves at all lowest points of the field piping to drain the water from the system before it can freeze.

To install antifreeze valve

To protect the field piping against freezing, install the following parts:

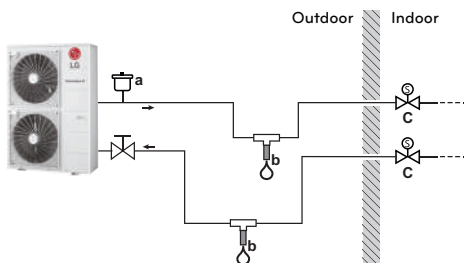

- a Automatic air intake
- b Antifreeze valve (Optional – field supply)
- c Normally closed valves (recommended – field supply)

Part	Description
	An automatic air intake (for air supply) should be installed at the highest point. For example, an automatic air purge.
	Protection for the field piping. The antifreeze valve must be installed: <ul style="list-style-type: none"> • Vertically to allow water to flow out properly and free from obstructions. • At all lowest points of the field piping. • In the coldest part and away from heat sources.
	Isolation of water inside the house when there is a power interruption. Normally closed valves (located indoors near the piping entry/exit points) can prevent that all water from indoor piping is drained when the antifreeze valve open. <ul style="list-style-type: none"> • When there is a power interruption: The normally closed valves close and isolate the water inside the house. If the antifreeze valve open, only the water outside the house is drained. • In other circumstances (example: when there is a pump failure): The normally closed valves remain open. If the antifreeze valve open, the water from inside the house is also drained.

NOTE

- Do not make any trap connections. If the shape of the connection pipe has the potential to create a trap effect, part of the pipe will not be able to drain and frost protection will no longer be guaranteed.
- Leave at least 15 cm clearance from the ground to prevent ice from blocking the water exit.
- Keep a distance of at least 10 cm between the antifreeze valves.
- The valve must be free of insulation for the system to work properly.
- When antifreeze valves are installed, do NOT select a minimum cooling setpoint lower than 7 °C. If lower, antifreeze valves can open during cooling operation.
- When installed outdoors, the antifreeze valve must be protected from rain, snow and direct sunlight.

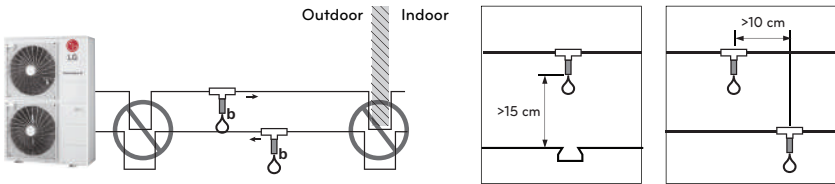

Water Volume and Expansion Vessel Pressure

Inside expansion vessel is included which is 8 liter capacity with 1 bar pre-pressure. That means, according to the volume-pressure graph, total water volume of 230 liter is supported as default. If total water volume is changed because of installation condition, the pre-pressure should be adjusted to secure proper operation.

- Minimum total water volume is 20 liter.
- Pre-pressure is adjusted by the total water volume. If the indoor is located at the highest position of the water circuit, adjustment is not required.
- To adjust pre-pressure, use nitrogen gas by certificated installer.

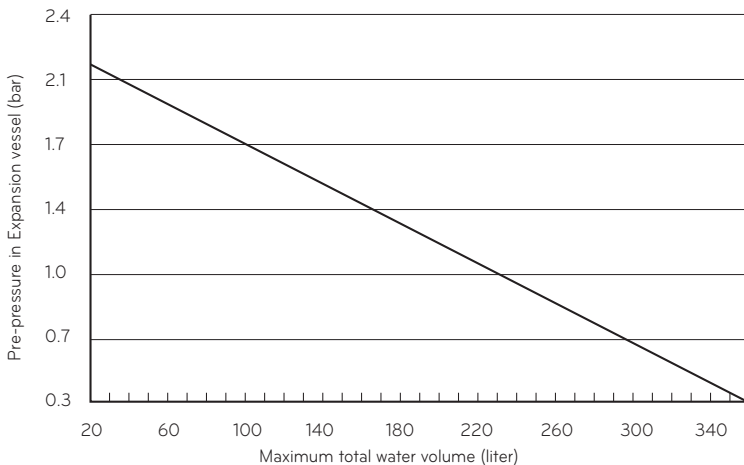

Adjusting pre-pressure of expansion vessel is as following :

Step 1. Refer "Volume-Height" table.

If installation scene is belong to Case A, go to Step 2.

Otherwise, if it is Case B, do nothing. (pre-pressure adjustment is not required.)

Otherwise, if it is Case C, go to Step 3.

Step 2. Adjust pre-pressure by following equation.

$$\text{Pre-pressure [bar]} = (0.1 \times H + 0.3) \text{ [bar]}$$

where H : difference between unit and the highest water pipe

0.3 : minimum water pressure to secure product operation

Step 3. Volume of expansion vessel is less than installation scene.

Please install additional expansion vessel at the external water circuit.

Volume-Height Table

	V < 230 liter	V ≥ 230 liter
H < 7 m	Case B	Case A
H ≥ 7 m	Case A	Case C

H : difference between unit and the highest water pipe

V : total water volume of installation scene

ACCESSORIES INSTALLATION

THERMAV. can interface to various accessories to extend its functionality and to improve user convenience. In this chapter, specifications about supported 3rd party accessories and how to connect to **THERMAV.** is introduced.

It is noted that this chapter only deal with 3rd party accessories. For accessories supported by LG Electronics, please refer to installation manual of each accessories.

Accessories supported by LG Electronics

Item	Purpose	Model
DHW Tank Kit	To operate with DHW tank	PHLTA : 1Ø PHLTC : 3Ø
Remote Air Sensor	To control by air temperature	PQRSTA0
Dry Contact	To receive on & off external signal	PDRYCB000
	Dry Contact For Thermostat	PDRYCB320
Solar Thermal Kit	To operate with solar heating system	(For Split) PHLLA (Limit temperature : 96 °C)
DHW Tank	To generate and store hot water	OSHW-200F : 200 L, Single Heating Coil, 1Ø 230 V 50 Hz 2.4 kW Booster heater OSHW-300F : 300 L, Single Heating Coil, 1Ø 230 V 50 Hz 2.4 kW Booster heater OSHW-500F : 500 L, Single Heating Coil, 1Ø 230 V 50 Hz 2.4 kW Booster heater OSHW-300F : 300 L, Double Heating Coil, 1Ø 230 V 50 Hz 2.4 kW Booster heater
Thermistor for DHW Tank	To control hot water temperature of DHW tank	PHRSTA0
Drain Pan	To prevent drain water drop	PHDPB
Meter Interface	To measure production / consumption power	PENKTH000
Central Controller	Multiple installed products into one central control	AC EZ Touch (PACEZA000) AC Smart IV (PACS4B000) AC Smart 5 (PACS5A000) ACP 5 (PACP5A000) AC Manager 5 (PACM5A000)

Item	Purpose	Model
PI485	To use Central Controller	PP485A00T
Cloud Gateway	To use Becon cloud	PWFMDDB200
Wi-Fi Modem	To enable remote system operation from smartphone	PWFMDDD200
Extension cable for Wi-Fi Modem	To connect with Wi-Fi modem to the USB cable	PWYREW000
Thermistor for 2nd Circuit or E/Heater	To interlock with 2nd circuit operation and control temperature of main zone or To interlock with 3rd party E/Heater and control temperature of water out3rd party E/Heater.	PRSTAT5K10
Extension wire	To connect remote controller with Indoor PCB for communication	PZCWRC1
Cover Plate	To relocate remote controller from indoor unit	PDC-HK10
Backup heater	To supplement in sufficient capacity	For Hydrosplit 1-Pipe HA061B E1 : 1Ø HA063B E1 : 3Ø For Hydrosplit 2-Pipe HA061C E1 : 1Ø HA063C E1 : 3Ø
ESS	To control the operation mode according to the energy storage state	(For Split Indoor unit 5 Series, For Hydrosplit) HOME 8 (PCS) : D008KE1N211 HOME10 (PCS) : D010KE1N211 HB7H (Battery) : BLGRESU7H HB10H (Battery) : BLGRESU10H
RS3 remote controller	To control unit with 2 remote controllers	PREMTW101
2-Remo Control Wire	The wire for 2 remo control	PZCWRC2

**CAUTION**

- Install the drain pan when cooling.
- If not installed, water may form.
- Please refer to separate installation manual when installing drain pan.

Accessories supported by 3rd party Companies

Item	Purpose	Specification
Solar Heating System	To generate auxiliary heating energy for water tank	(For Split Indoor unit 5 Series, For Hydrosplit) <ul style="list-style-type: none"> • Solar collector • Solar pump • 3way valve(B) • Solar Thermal Sensor : PT1000
Thermostat	To control by air temperature	Heating-Only type (230 V AC) Cooling/Heating type (230 V AC with Mode selection switch)
Mix Kit	To use 2 nd Circuit	<ul style="list-style-type: none"> • Mixing valve • Mix pump
3 rd Party Boiler	To use auxiliary boiler.	
3 rd Party Controller	To connect external controller using modbus protocol	
3way valve and actuator	(A) : To control water flow for hot water heating or floor heating / To control water flow when installing 3rd party boiler (B) : To control close/open mode of solar circuit	3 wire, SPDT (Single Pole Double Throw) type, 230 V AC
2way valve and actuator	To block underfloor heating coil from cooling water	2 wire, NO(Normal Open) or NC(Normal Closed) type, 230 V AC
External Pump	To control the water flow at the rear of the buffer tank	
Smart Grid	To control operation mode depending on input signal from provider	
3 rd Party ESS	To control the operation mode according to the energy storage state	(For Split Indoor unit 5 Series, For Hydrosplit)
3 rd party Backup heater	To supplement in sufficient capacity	(For Hydrosplit)
Antifreeze valve	To protect the pipes against freezing	
DHW Recirculation Pump	To control the water flow of DHW recirculation pump	(For Split Indoor unit 5 Series, Hydrosplit 2-Pipe)

Before Installation

! WARNING

Followings should be kept before installation

- Main power must be turned off during installing accessories.
- 3rd party accessories should be comply with supported specification.
- Proper tools should be chosen for installation.
- Never do installation with wet hands.

Thermostat

Thermostat is generally used to control the product by air temperature. When thermostat is connected to the product, the product operation is controlled by the thermostat.

Installation condition

! CAUTION

- USE 220-240 V~ Thermostat
- Some electro-mechanical type thermostat has internal delay time to protect compressor. In that case, mode change can takes time more than user's expectation. Please read thermostat manual carefully if the unit does not response quickly.
- Setting temperature range by thermostat can be different with that of the unit. The heating or cooling set temperature should be chosen within the setting temperature range of the unit.
- It is highly recommended that the thermostat should be installed where space heating is mainly applied.

Following location should be avoid to secure proper operation :

- Height from floor is approximately 1.5 m.
- Thermostat can not be located where the area may be hidden when door is open.
- Thermostat can not be located where external thermal influence may be applied. (such as above heating radiator or open window)

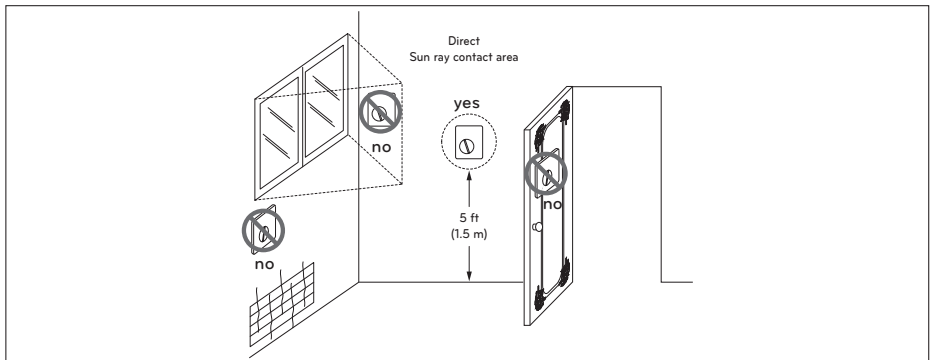

Thermostat

General Information

The Heat Pump supports following thermostats.

Type	Power	Operating Mode	Supported
Mechanical (1)	230 V~	Heating Only (3)	Yes
		Heating / Cooling (4)	Yes
		Heating / Cooling / DHW Heating (5)	Yes
Electrical (2)	230 V~	Heating Only (3)	Yes
		Heating / Cooling (4)	Yes
		Heating / Cooling / DHW Heating (5)	Yes

- (1) There is no electric circuit inside the thermostat and electric power supply to the thermostat is not required.
- (2) Electric circuit such as display, LED, buzzer, etc is included in the thermostat and electric power supply is required.
- (3) Thermostat generates "Heating ON or Heating OFF" signal according to user's heating target temperature.
- (4) Thermostat generates both "Heating ON or Heating OFF" and "Cooling ON or Cooling OFF" signal according to user's heating and cooling target temperature.
- (5) Thermostat generates "Heating ON or Heating OFF", "Cooling ON or Cooling OFF", "DHW Heating ON or DHW Heating OFF" signal according to user's heating, cooling and DHW heating target temperature. (For Split Indoor unit 5 Series, For Hydrosplit)



CAUTION

Choosing heating / cooling thermostat

- Heating / cooling thermostat must have "Mode Selection" feature to distinguish operation mode.
- Heating / cooling thermostat must be able to assign heating target temperature and cooling target temperature differently.
- If above conditions are not kept, the unit can not operation properly.
- Heating / cooling thermostat must send cooling or heating signal immediately when temperature condition is satisfied. No delay time while sending cooling or heating signal is permitted.

How to wire thermostat

Follow below procedures Step 1 ~ Step 5.

Step 1. Uncover front cover of the unit and open the control box.

Step 2. Identify the power specification of the thermostat. If it is 220-240 V~, go to Step 3.

Step 3. If it is Heating only thermostat, go to step 4. Otherwise, if it is Heating / cooling thermostat, go to step 5.

Step 4. Find terminal block and connect wire as below.

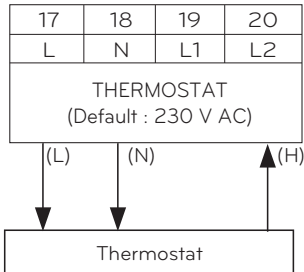

! WARNING

Mechanical type thermostat.

Do not connect wire (N) as mechanical type thermostat does not require electric power supply.

! CAUTION

Do not connect external electric loads.

Wire (L) and (N) should be used only for operation electric type thermostat.

Never connect external electric loads such as valves, fan coil units, etc. If connected, Main PCB (Heater) can be seriously damaged.

(L) : Live signal from PCB to thermostat

(N) : Neutral signal from PCB to thermostat

(H) : Heating signal from thermostat to PCB

Step 5. Find terminal block and connect wire as below.

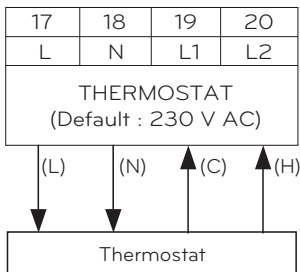

! WARNING

Mechanical type thermostat.

Do not connect wire (N) as mechanical type thermostat does not require electric power supply.

! CAUTION

Do not connect external electric loads.

Wire (L) and (N) should be used only for operation Electric type thermostat.

Never connect external electric loads such as valves, fan coil units, etc. If connected, Main PCB (Heater) can be seriously damaged.

(L) : Live signal from PCB to thermostat

(N) : Neutral signal from PCB to thermostat

(C) : Cooling signal from thermostat to PCB

(H) : Heating signal from thermostat to PCB

How to wire Heating / Cooling / DHW Heating thermostat (For Split Indoor unit 5 Series, For Hydrosplit)

Follow below procedures Step 1 ~ Step 3.

Step 1. Uncover front cover of the unit and open the control box.

Step 2. Identify the power specification of the thermostat. If it is 220-240 V~, go to Step 3.

Step 3. Find terminal block and connect wire as below.

For Split Indoor unit 5 Series
For Hydrosplit 2-Pipe

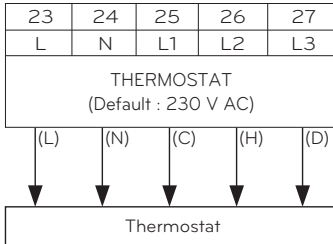

For Hydrosplit 1-Pipe

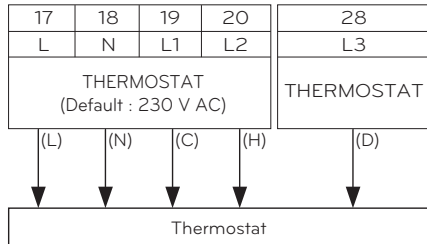

! WARNING

Mechanical type thermostat.

Do not connect wire (N) as mechanical type thermostat does not require electric power supply.

! CAUTION

Do not connect external electric loads.

Wire (L) and (N) should be used only for operation electric type thermostat.

Never connect external electric loads such as valves, fan coil units, etc. If connected, Main PCB (Heater) can be seriously damaged.

(L) : Live signal from PCB to thermostat

(N) : Neutral signal from PCB to thermostat

(C) : Cooling signal from thermostat to PCB

(H) : Heating signal from thermostat to PCB

(D) : DHW Heating signal from thermostat to PCB

Final check

- DIP switch setting :
Set DIP switch No. 8 to 'ON'. Otherwise, the unit can not recognize the thermostat.
- Remote Controller :
 - 'Thermostat' text is displayed on the remote controller.
 - Button input is prohibited.
 - In case of Heating / Cooling / DHW Heating thermostat, select 'Heat&Cool / DHW' as the Thermostat Control Type in the remote controller installer settings.

2nd Circuit

The 2nd circuit is generally used to control the temperature of 2 rooms differently. To use the 2nd Circuit, you need to prepare a separate Mix Kit. The mix kit must be installed in the circuit 2.

- For Split R32 Indoor unit 4 Series, For Split R410A Indoor unit 3 Series

[Install Guide 2nd Circuit Heating]

Circuit 1 \ Circuit 2	Floor (35°C)	Convector (FCU, 45 °C)	Radiator (45 °C)	Radiator (55 °C)
Floor (35 °C)	○	X	X	X
Convector (FCU, 45 °C)	○	○	○	X
Radiator (45 °C)	○	○	○	X
Radiator (55 °C)	○	○	○	○

[Install Guide 2nd Circuit Cooling]

Circuit 1 \ Circuit 2	Floor (18 °C)	Convector (FCU, 5 °C)
Floor (18 °C)	○	X
Convector (FCU, 5 °C)	○	○

- For Split Indoor unit 5 Series, For Hydrosplit

[Install Guide 2nd Circuit Heating]

Circuit 1 \ Circuit 2	Floor (35°C)	Convector (FCU, 45 °C)	Radiator (45 °C)	Radiator (55 °C)
Floor (35 °C)	○	○	○	○
Convector (FCU, 45 °C)	○	○	○	○
Radiator (45 °C)	○	○	○	○
Radiator (55 °C)	○	○	○	○

[Install Guide 2nd Circuit Cooling]

Circuit 1 \ Circuit 2	Floor (18 °C)	Convector (FCU, 5 °C)
Floor (18 °C)	○	○
Convector (FCU, 5 °C)	○	○

※ To use a floor combination during cooling operation, the flow through the floor of the flow must be blocked by the 2 way valve.

NOTE

Circuit 1 = Direct circuit : Zone where the water temperature is lowest when heating

Circuit 2 = Mixing circuit : The other zone

How to Wire Mix Pump, Mixing Valve and Thermistor for 2nd Circuit (For Split R32 4 Series, For Split R410A 3 Series)

Follow below procedures Step 1 ~ Step 3.

Step 1. Uncover front cover of the unit.

Step 2. Find terminal block and connect wire as below

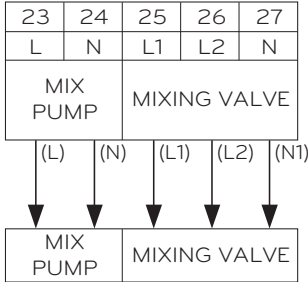

(L) : Live signal from PCB to mix pump

(N) : Neutral signal from PCB to mix pump

(L1) : Live signal (for Normal* Closed type) from PCB to mixing valve

(L2) : Live signal (for Normal Open type) from PCB to mixing valve

(N1) : Neutral signal from PCB to mixing valve

*Closed = NOT Mixed

Step3. Insert the temperature sensor to 'CN_MIX_OUT' (Brown) of the main PCB as shown below. The sensor should be mounted correctly to discharge pipe of mix pump as shown below.

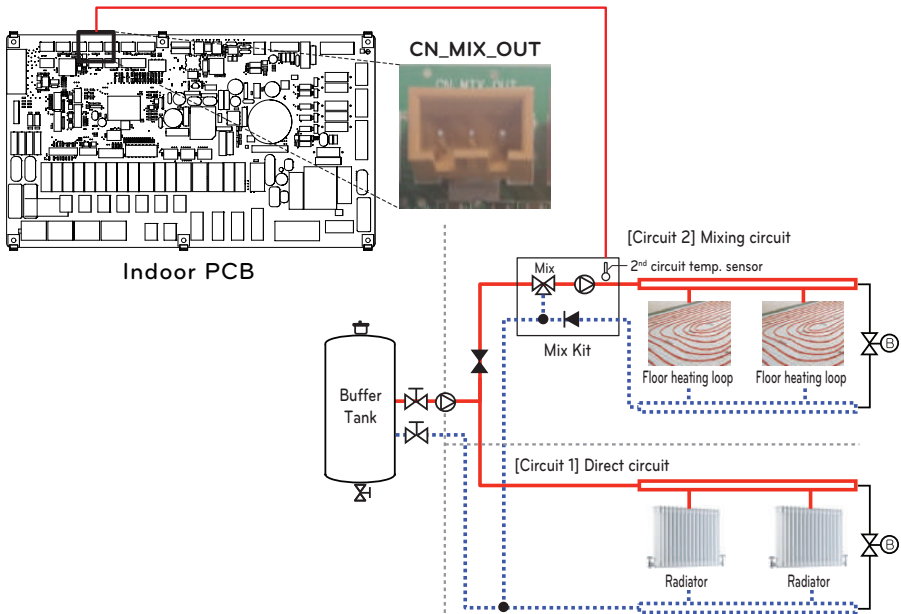

NOTE

Temperature sensor specification:

Type : Thermistor, NTC

Resistance at 25 °C : 5 kΩ

Minimum operating temperature range : -30 °C~100 °C

[Thermistor for 2nd circuit]

Sensor



Sensor Holder



Sensor Connector

Follow below procedures step 1 ~ step 4.

Step 1. Install sensor connector to discharge pipe of mix pump.

(Welding must be performed to connect the sensor connector to the pipe)

Step 2. Check if the power of the unit is turned off.

Step 3. Fasten the sensor connector to the sensor holder as shown in the figure below.

Step 4. Insert harness into PCB(CN_TH4) fully and fix the thermal sensor into tube connector as shown below.



How to Wire Mix Pump, Mixing Valve and Thermistor for 2nd Circuit (For Split Indoor unit 5 Series, For Hydrosplit)

Follow below procedures Step 1 ~ Step 3.

Step 1. Uncover front cover of the unit.

Step 2. Find terminal block and connect wire as below

For Split Indoor unit 5 Series
For Hydrosplit 2-Pipe

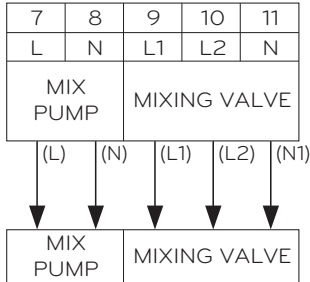

For Hydrosplit 1-Pipe

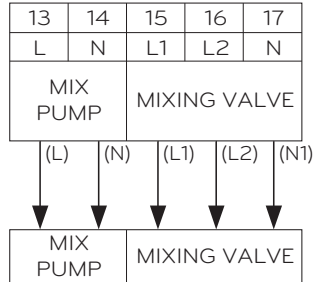

(L) : Live signal from PCB to mix pump

(N) : Neutral signal from PCB to mix pump

(L1) : Live signal (for Normal* Closed type) from PCB to mixing valve

(L2) : Live signal (for Normal Open type) from PCB to mixing valve

(N1) : Neutral signal from PCB to mixing valve

*Closed = NOT Mixed

Step3. Insert the temperature sensor to 'CN_MIX_OUT' (Brown) of the main PCB as shown below. The sensor should be mounted correctly to outlet pipe of mix kit water pump as shown below.

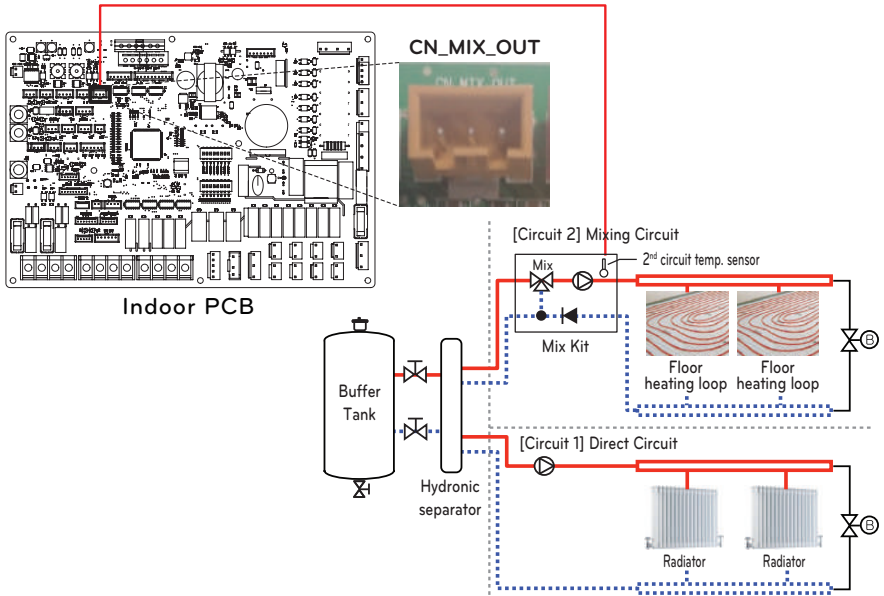

NOTE

Temperature sensor specification:

Type : Thermistor,NTC

Resistance at 25 °C : 5 kΩ

Minimum operating temperature range : -30 °C~100 °C

3rd party Backup heater (For Hydrosplit)

The product can be used by connecting an Auxiliary Backup heater. You can control the Backup heater automatically and manually by comparing the water out temperature of Backup heater and the set temperature.

How to install 3rd party Backup heater

Follow below procedures Step 1 ~ 4.

Step 1. Find the middle link harness and the temperature sensor.

Step 2. Insert connector(Brown) of the temperature sensor to connector(White) of the middle link harness as shown below.

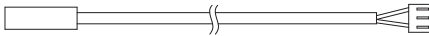

Temperature sensor

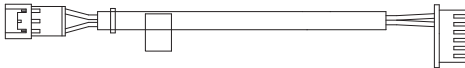

Middle Link Harness

Step 3. Insert connector(Black) of middle link harness to 'CN_TH3' in the Main PCB connector(Black) as shown below. The sensor should be mounted correctly to outlet pipe of backup heater as shown below.

[Thermistor for 3rd party Backup heater]

Sensor



Sensor Holder



Sensor Connector

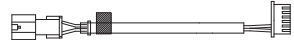

Middle link harness

Follow below procedures Step 1 ~ 4.

Step 1. Install sensor connector to outlet pipe of backup heater.

(Welding must be performed to connect the sensor connector to the pipe.)

Step 2. Check if the power of the unit is turned off.

Step 3. Fasten the sensor connector to the sensor holder as shown in the figure below.

Step 4. Insert harness into PCB(CN_TH3) fully and fix the thermal sensor into tube connector as shown below.



3rd Party Boiler

The product can be used by connecting an Auxiliary boiler. 3rd party boiler can be controlled by manually via remote controller or automatically itself by means of comparing the outside air temperature and the pre-set temperature.

How to wire 3rd party boiler

Follow below procedures step 1 ~ step 3.

Step 1. Check if the power of the unit is turned off.

Step 2. Disassemble front panels and Distinguish terminal block in Indoor PCB.

Step 3. Connect Power cable to terminal block (TB_BOILER) fully.

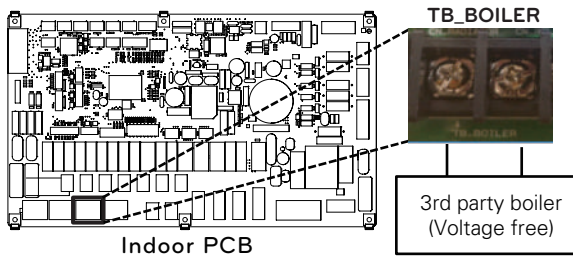

(For Split R32 Indoor unit 4 Series, For Split R410A Indoor unit 3 Series)

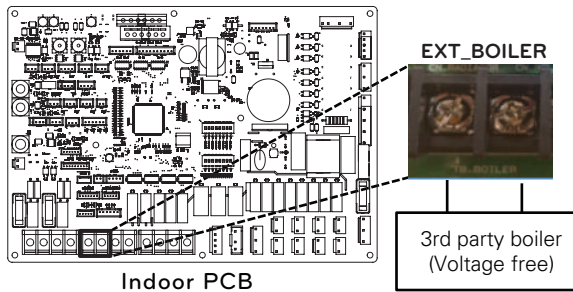

(For Split Indoor unit 5 Series, For Hydrosplit)

3rd Party Controller

The product can also be linked to 3rd party controller. 3rd party boiler can be controlled by manually via RS3 remote controller or automatically itself by means of comparing the outside air temperature and the pre-set temperature.

How to wire 3rd party controller

Follow below procedures step 1 ~ step 4.

- Step 1.** Check if the power of the unit is turned off.
- Step 2.** Disassemble front panels and distinguish control box(Indoor) of the unit.
- Step 3.** Check if the harness(White) is inserted fully to the indoor unit PCB (CN_COM).
- Step 4.** Connect the 3rd party controller to terminal block 4(21/22) completely. (including Meter interface module)

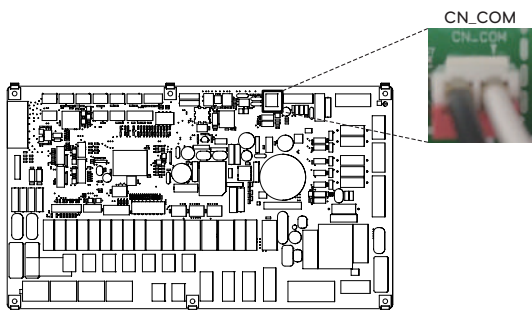
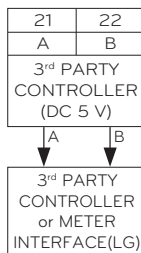

Indoor PCB

(For Split R32 Indoor unit 4 Series, For Split R410A Indoor unit 3 Series)

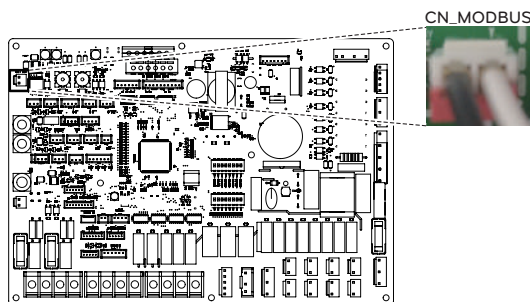

Indoor PCB

(For Split Indoor unit 5 Series, For Hydrosplit)

Meter Interface

This product can be used by connecting the meter interface module supplied in the field. The meter interface module can communicate with the wired remote controller. The meter interface module lets you know the amount of power generated by the product.

How to install Meter Interface

[Parts of Meter interface]

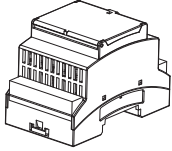

Meter interface body

Follow below procedures step 1 ~ step 4.

Step 1. Check if the power of the unit is turned off.

Step 2. Disassemble front panels and Distinguish control box(Indoor) of the unit.

Step 3. Check if the harness(White) is inserted fully to the indoor unit PCB (CN_COM).

Step 4. Connect the external pump to terminal block 4(21/22).

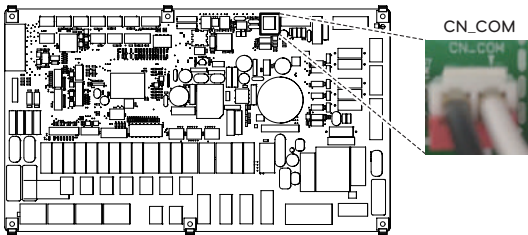

Indoor PCB

(For Split R32 Indoor unit 4 Series, For Split R410A Indoor unit 3 Series)

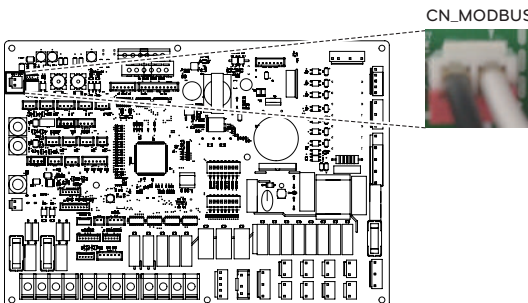

Indoor PCB

(For Split Indoor unit 5 Series, For Hydrosplit)

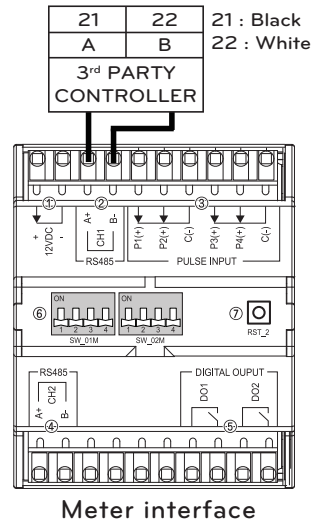

Central Controller

The product can communicate and control through the central controller. The following functions can be controlled in the central control linked state (Operation/Stop, Desired temperature, Hot water operation / stop, Warm water temperature, Full lock, Etc)

How to Install Central Controller

To use central controller, you need to establish an environment for mutual communication between central controller and the THERMA V and register the corresponding devices through the functions of central controller. To use central controller, it shall be installed in the following order.

Step 1. Installation environment inspection and device address setting

Before installing central controller, check the network for any interfacing devices and assign non overlapping addresses to the connected devices.

Step 2. PI485 setting

Install PI485 and set the DIP switch accordingly.

Step 3. Connections

Connect PI485 and central controller through RS-485 cable.

Step 4. Access and Device Registration

Log in to central controller and register device with address set.

Consult a qualified engineer/ technician for the installation of central controller. If you have any installation queries, contact the LG service center or LG Electronics.

How to Installation PI485

Fix the PI485 PCB as shown in below images.

For detailed installation method refer to PI485 Installation Manual

Product Heating Capacity : 12 kW, 14 kW, 16 kW Product Heating Capacity : 5 kW, 7 kW, 9 kW

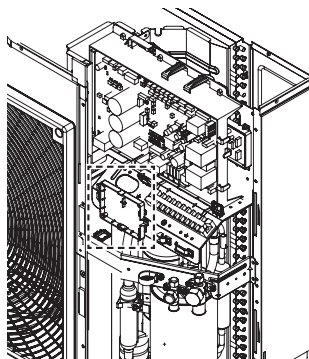
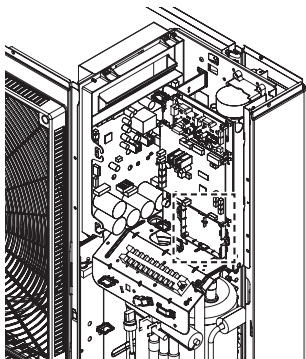

- For detailed installation instructions, refer to the manual included in the accessories.

DHW Tank

To establish DHW circuit, 3way valve and DHW tank kit is required. If solar thermal system is pre-installed at the installation field, solar thermal kit is required to interface solar thermal system – to – DHW tank – to – **THERMAV**.

Installation condition

Installing DHW tank following considerations :

- DHW tank should be located at the flat place.
- Water quality should be complied with EN 98/83 EC directives.
- As this water tank is sanitary water tank (indirect heat exchange), do not use anti water-freezing treatment like ethylene glycol.
- It is highly recommend to wash out inside of the DHW tank after installation. It ensures generating clean hot water.
- Near the DHW tank there should be water supply and water drain to easy access and maintenance.
- Set the maximum value of the temperature control device of DHW tank.

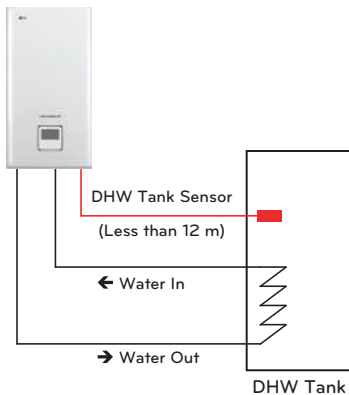

* Water In / Water Out installation scene may vary depending on the model.

General Information

THERMAV supports following 3way valve.

Type	Power	Operating Mode	Supported
SPDT 3-wire (1)	230 V AC	Selecting "Flow A" between "Flow A" and "Flow B" (2)	Yes
		Selecting "Flow B" between "Flow A" and "Flow B" (3)	Yes

(1) : SPDT = Single Pole Double Throw. Three wires consist of Live1 (for selecting Flow A), Live 2 (for selecting Flow B), and Neutral (for common).

(2) : 'Flow A' means water flow from the unit to under floor water circuit.

(3) : 'Flow B' means water flow from the unit to DHW tank.

Installing recirculation pump (For Split R32 4 Series, Split R410A 3 Series, Hydrosplit 1-pipe)

When **THERMAV** is used with DHW tank, it is **STRONGLY** recommended to install recirculation pump to prevent flooding out cold water at the end of hot water supply and to stabilize the water temperature inside DHW tank

- The recirculation pump should be operated when DHW demand is not required. Therefore, external time scheduler to determine when the recirculation pump should turn on and turn off is required.
- The operating duration time of the recirculation pump is calculated as follow :
Duration time [minute] = $k \times V \times R$
k : 1.2 ~ 1.5 is recommended. (If distance between pump and tank is far, then choose high number)
V : Volume of DHW tank [liter]
R : Water flow rate of pump [liter per minute], which is determined by pump performance curve.
- The pump operating start time should be prior to the DHW demand.

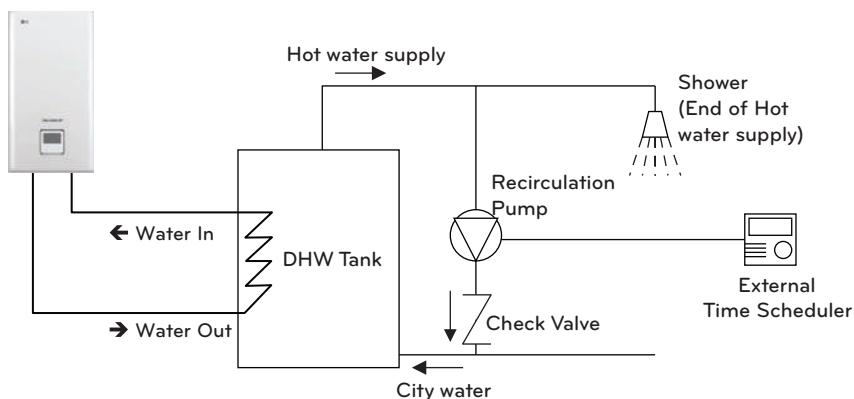

* Water In / Water Out installation scene may vary depending on the model.

Installing recirculation pump (For Split indoor unit 5 series, Hydrosplit 2-pipe)

When **THERMAV** is used with DHW tank, it is STRONGLY recommended to install recirculation pump to prevent flooding out cold water at the end of hot water supply and to stabilize the water temperature inside DHW tank

- The recirculation pump should be operated when DHW demand is not required. Therefore, external time scheduler to determine when the recirculation pump should turn on and turn off is required.
- The operating duration time of the recirculation pump is calculated as follow :
Duration time [minute] = $k \times V \times R$
k : 1.2 ~ 1.5 is recommended. (If distance between pump and tank is far, then choose high number)
V : Volume of DHW tank [liter]
R : Water flow rate of pump [liter per minute], which is determined by pump performance curve.
- The pump operating start time should be prior to the DHW demand.

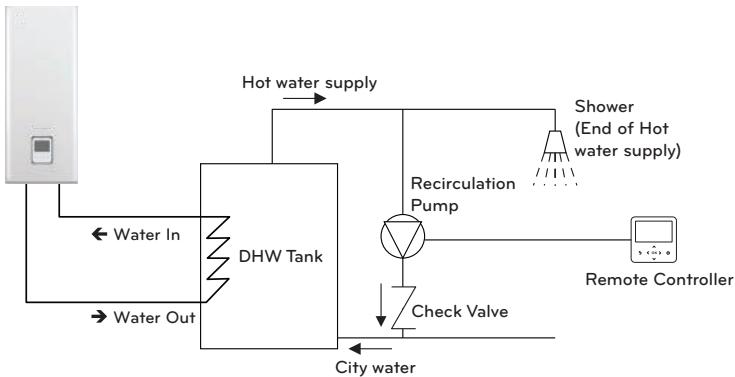

* Water In / Water Out installation scene may vary depending on the model.

NOTE

- For more information about recirculation pump, Please refer chapter 8 and chapter 9 of **THERMAV** installation manual and owners manual.

How to wire recirculation pump

Follow below procedures step 1 ~ step 4.

- Step 1.** Check if the power of the unit is turned off.
- Step 2.** Disassemble front panels and distinguish control box(Indoor) of the unit.
- Step 3.** Check if the harness(Violet) is inserted fully to the indoor unit PCB (CN_PUMP_A15).
- Step 4.** Connect the DHW recirculation pump to terminal block 1(3/4).

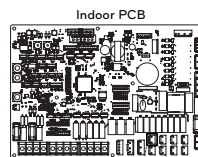

CN_PUMP_A15

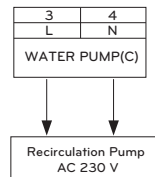

How to Wire Booster Heater

Step 1. Uncover heater cover of the DHW tank. It is located side of the tank.

Step 2. Find terminal block and connect wires as below. Wires are field-supplied item.

(L) : Live signal from PCB to Heater.

(N) : Neutral signal from PCB to Heater.

⚠ WARNING

Wire specification

- Cross-sectional area of the wire should be 6 mm².

Adjusting thermostat temperature

- To guarantee proper operation, it is recommended to set temperature of thermostat to maximum temperature (symbol **A** at the picture).
- 1Ø Backup Heater Model and 3Ø Backup Heater Model are set by same method as below.

For Split R32 Indoor unit 4 Series,
For Split R410A Indoor unit 3 Series,
For Hydrosplit 1-Pipe

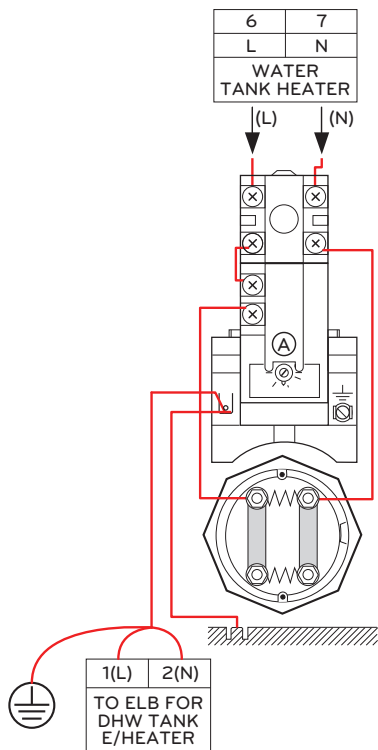

For Split Indoor unit 5 Series
For Hydrosplit 2-Pipe

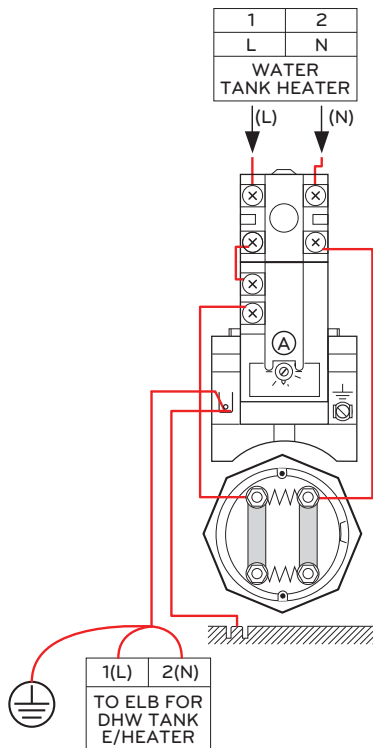

DHW Tank Kit

This product can be used by connecting the DHW tank kit in the field. It can be utilized hot water heated by booster heater in DHW tank.

How to install DHW tank kit

[Parts of DHW Tank Kit]

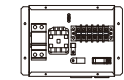

Tank kit body



Sensor

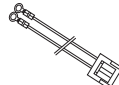

Multi harness

Temperature sensor for DHW tank is used to control hot water temperature of DHW tank. If sensor will be defective, you can purchase it separately.(Model name : PHRSTA0)

Follow below procedures step 1 ~ step 4.

Step 1. Uncover DHW tank kit and locate it on the wall.

Step 2. Connect Harness of Main PCB assembly(TB1(6/7)) to 'CN_B_Heat_A' of the Main PCB like following fig. 1.

Step 3. Insert DHW tank sensor to 'CN_TH4' (Red) of the Main PCB refer as below.

Step 4. Connect power supply to the DHW tank kit as shown fig. 1.

* The sensor should be mounted correctly to the sensor hole of DHW water tank like below fig. 1.

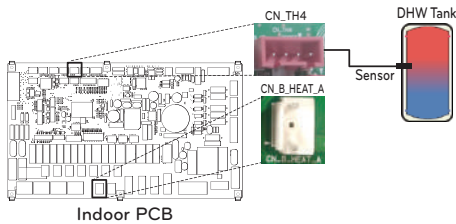

(For Split R32 Indoor unit 4 Series,
For Split R410A Indoor unit 3 Series)

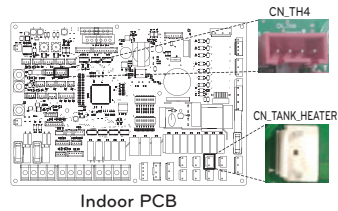

(For Split Indoor unit 5 Series, For Hydrosplit)

Fig. 1

For Split R410A Indoor unit 3 Series,
For Split R32 Indoor unit 4 Series,
For Hydrosplit 1-Pipe

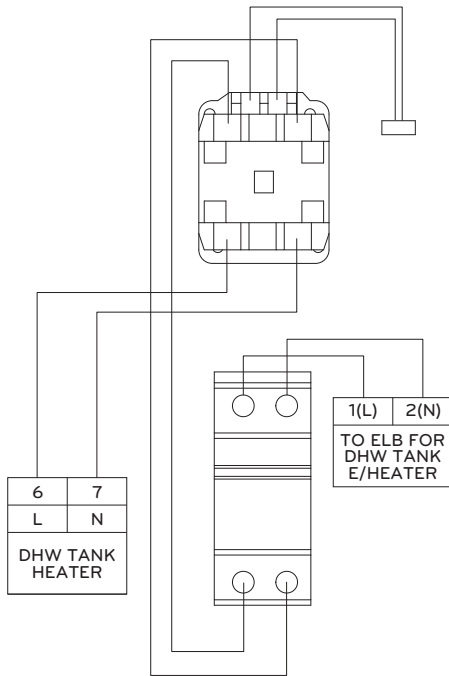

For Split Indoor unit 5 Series
For Hydrosplit 2-Pipe

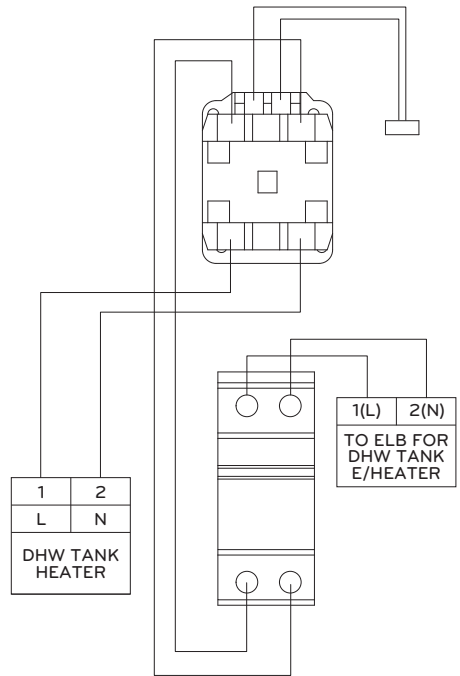

Check Polarity (For Split R410A Indoor unit 3 Series, For Split R32 Indoor unit 4 Series)

Booster heater for 1Ø model

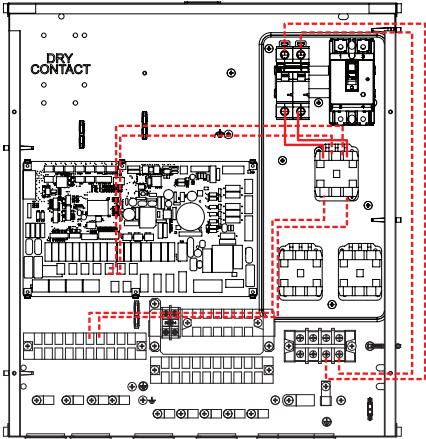

With magnet switch
(Production date : Until Sep. 30, 2019)

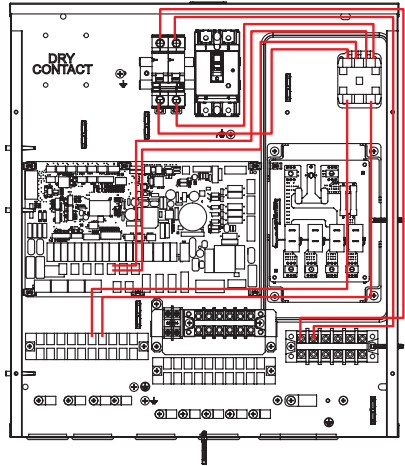

With heater PCB
(Production date : From Oct. 1, 2019)

Booster heater for 3Ø model

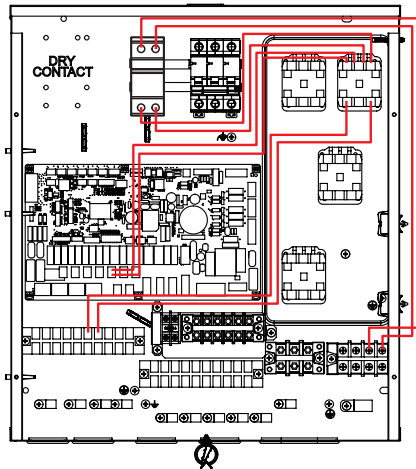

Check Polarity (For Split Indoor unit 5 Series)

Booster heater for 1Ø model

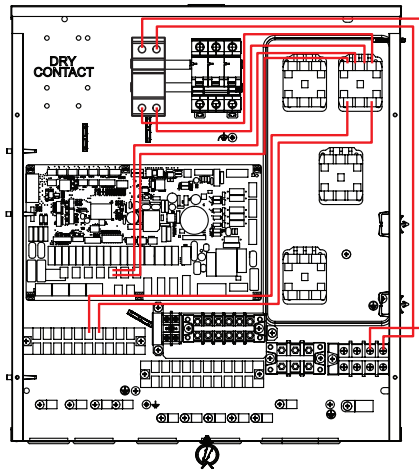

Booster heater for 3Ø model

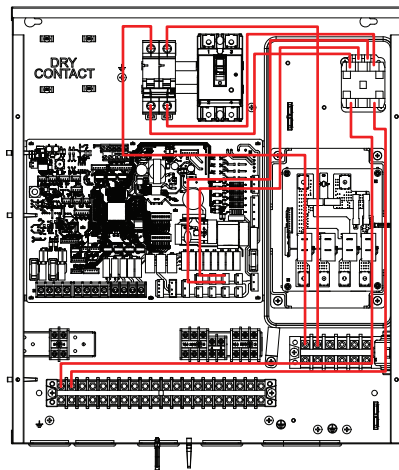

Solar Thermal Kit

This product can be used by connecting the solar thermal kit in the field. It can be utilized hot water heated by solar thermal system. End-user must be install solar thermal kit accessory(PHLLA) provided by LG.

How to Install Solar Thermal Kit

[Parts of Solar Thermal Kit]



Sensor Holder

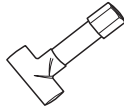

Tube Connector



Solar Thermal Sensor

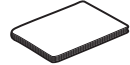

Installation Manual

Follow below procedures step 1 ~ step 4.

Step 1. Install tube connector on the pipe of solar thermal system and insert the sensor holder and solar thermal sensor in order. A reducer or expander could be required to fit with the piping diameter.

Step 2. Check if the power of the unit is turned off.

Step 3. Disassemble front panels and distinguish control box(Indoor) of the unit.

Step 4. Insert harness into PCB fully and fix the thermal sensor into tube connector as shown below.

* If the DHW tank sensor is connected, disconnect the sensor from PCB first.
Solar Thermal Sensor : PT1000 (Field Supply)

For Split R32 Indoor unit 4 Series, For Split R410A Indoor unit 3 Series

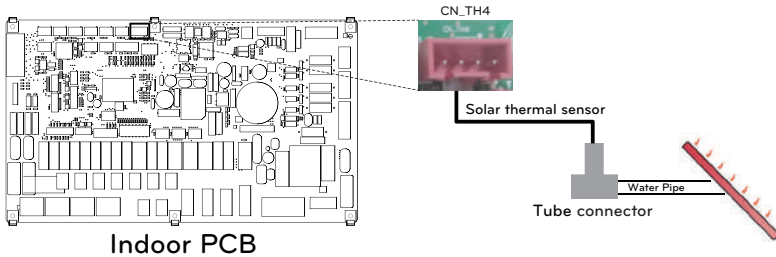

For Split Indoor unit 5 Series, For Hydrosplit

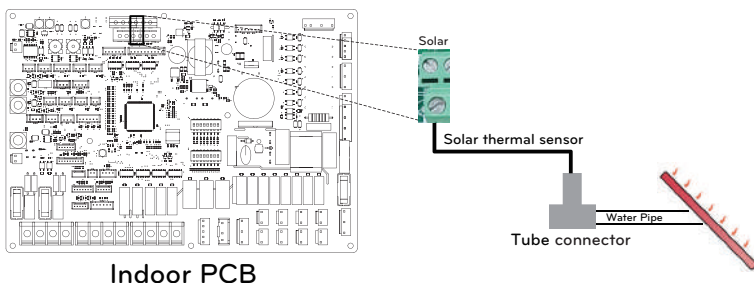

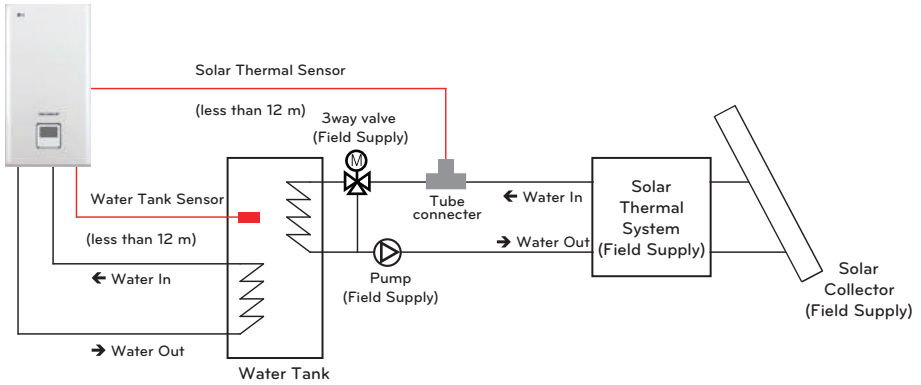

* Water In / Water Out installation scene may vary depending on the model.

- insert sensor until the cable tie as shown below.



CAUTION

Sensor mounting

Insert sensor into sensor socket and bolt it tightly.

Dry Contact

Dry Contact is a solution for automatic control of HVAC system at the owner's best. In simple words, it's a switch which can be used to turn the unit On/Off after getting the signal from external sources.

How to install dry contact

[Parts of Dry contact]

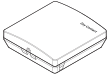

Dry Contact body



Cable(for connecting with IDU)

Follow below procedures step 1 ~ step 4.

Step 1. Check if the power of the unit is turned off.

Step 2. Disassemble front panels and distinguish terminal block in Indoor PCB.

Step 3. Connect cable to the unit PCB(CN_CC) fully.

Step 4. Then, Insert harness to the dry contact PCB(CN_INDOOR) firmly as shown below.

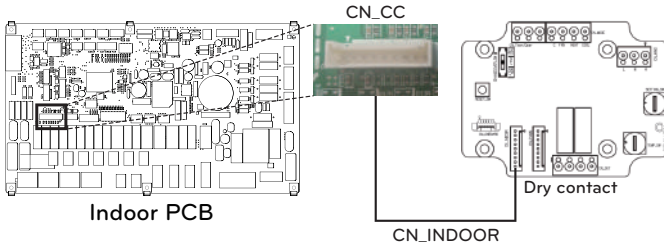

(For Split R32 Indoor unit 4 Series, For Split R410A Indoor unit 3 Series)

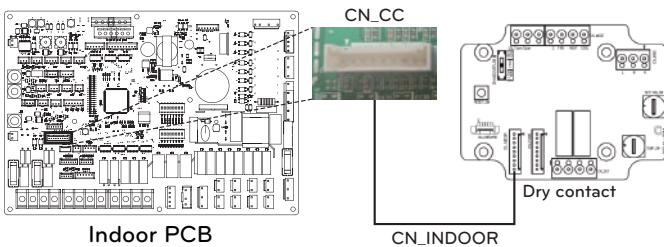

(For Split Indoor unit 5 Series, For Hydrosplit)

NOTE

- For more information about installing Dry Contact, Please refer installation manual provided with Dry Contact.
- For system set-up, please read chapter 8 (Accessory Installation) and chapter 9 (DIP Switch setting).

[Setting of Contact Signal Input]

- For input contact closure only (No power input)

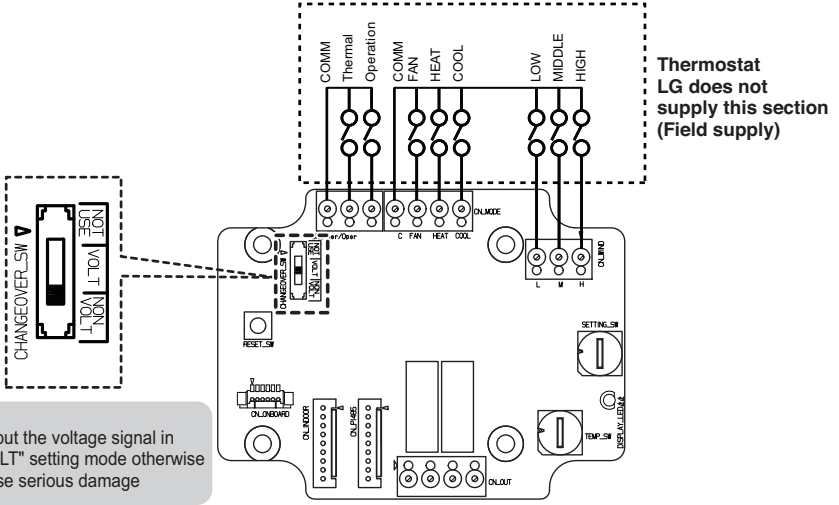

Notes
Do not input the voltage signal in "NON VOLT" setting mode otherwise it will cause serious damage

- For input contact voltage : DC 12 V, 24 V~

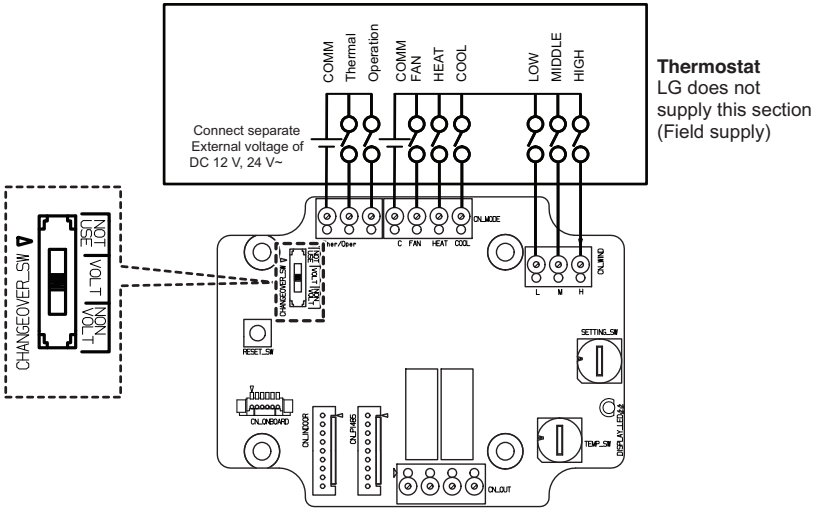

Thermostat LG does not supply this section (Field supply)

External Controller - Setting up programmable digital input operation

If you require to control depending on external digital input(ON/OFF), connect cable to indoor PCB(CN_EXT).

Follow below procedures step 1 ~ step 4.

Step 1. Check if the power of the unit is turned off.

Step 2. Disassemble front panels and distinguish control box(Indoor) of the unit

Step 3. Connect the external controller to PCB(CN_EXT) completely.

Step 4. Connect the cable and field installation part.

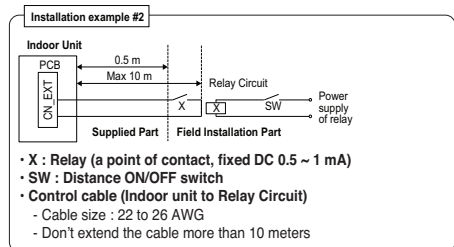
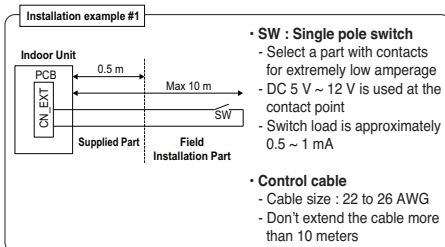
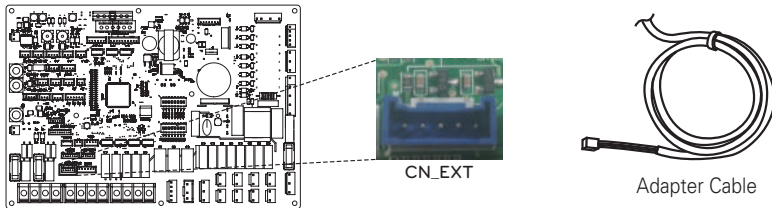
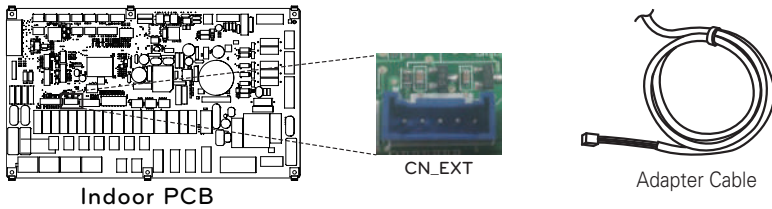

Remote Temperature Sensor

Remote temperature sensor can be installed any place a user wants to detect the temperature.

- The function is not available for some products.

Installation condition

Role and constraint while installation of remote air temperature sensor is very similar to that of thermostat.

- Distance between the unit and the remote air temperature sensor should be less than 15 m due to length of the connection cable of remote air temperature sensor.
- For other constraints, please refer to previous page where constraints about thermostat is described.

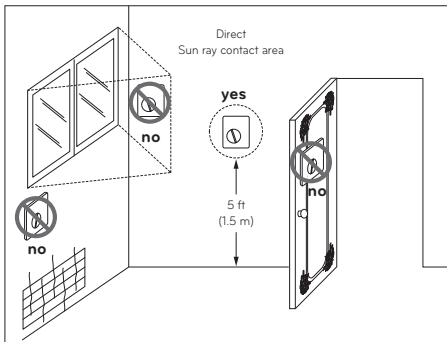

Thermostat

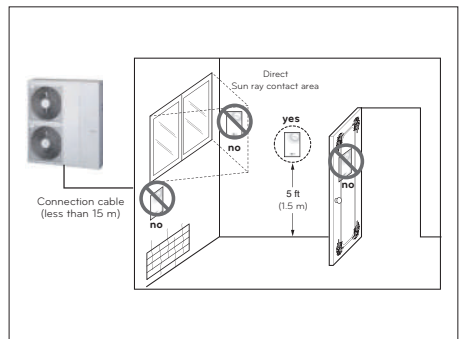

Remote Air Temperature Sensor

How to Install Remote Temperature Sensor

[Parts of Remote Temperature Sensor]



Cable



Screw(to fix remote sensor)

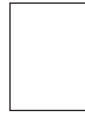

Installation Manual

Follow below procedures step 1 ~ step 6.

Step 1. Decide where the remote temperature sensor is installed. Then, Determine the location and height of the fixing screws in fig. 1 (Interval between the screws : 60 mm)

Step 2. Check if the power of the unit is turned off.

Step 3. Disassemble front panels and distinguish control box(Indoor) of the unit.

Step 4. Insert temperature sensor into PCB(CN_ROOM) and fix the sensor firmly in fig. 2.

Step 5. The Connection wire does not matter if you change the color of the wire because of nonpolar.

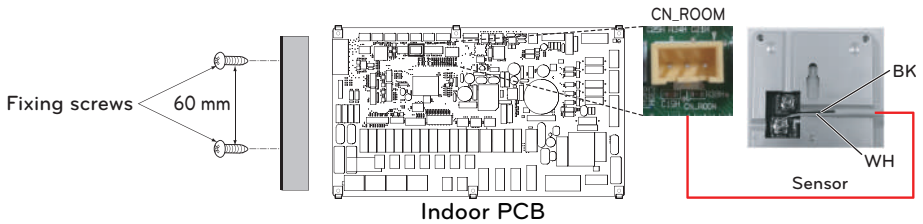

[fig. 1]

[fig. 2]

(For Split R32 Indoor unit 4 Series, For Split R410A Indoor unit 3 Series)

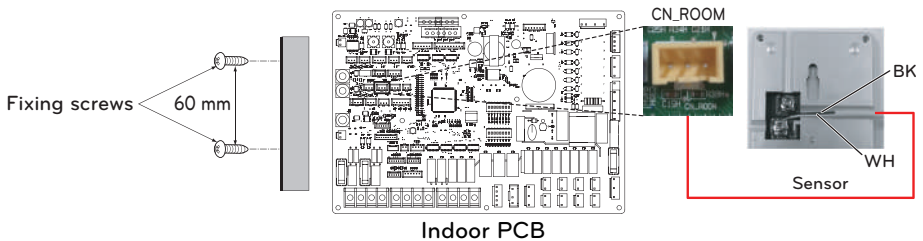

[fig. 1]

[fig. 2]

(For Split Indoor unit 5 Series, For Hydrosplit)

Step 6. Integrate the remote temperature sensor with the screws as the order of arrows.

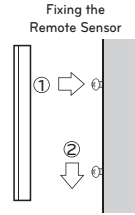

! CAUTION

- Choose the place where the average temperature can be measured for the unit operates.
- Avoid direct sunlight.
- Choose the place where the cooling/heating devices do not affect the remote sensor.
- Choose the place where the outlet of the cooling fan do not affect the remote sensor.
- Choose the place where the remote sensor isn't affected when door is open.

NOTE

- For more information about installing Remote Temperature Sensor, Please refer installation manual provided with Remote Temperature Sensor.
- For system set-up, please read chapter 8 (Accessory Installation) and chapter 9 (DIP Switch setting).

Solar pump

Solar pump can be required to energize water flow when solar thermal system is installed.

How to wire solar pump

Follow below procedures step 1 ~ step 4.

Step 1. Check if the power of the unit is turned off.

Step 2. Disassemble front panels and distinguish control box(Indoor) of the unit.

Step 3. Check if the harness(Black) is inserted fully to the indoor unit PCB (CN_W_PUMP_B).

Step 4. Connect the external pump to terminal block 1(4/5).

※ It is possible to un-use solar pump depending on instal environment.

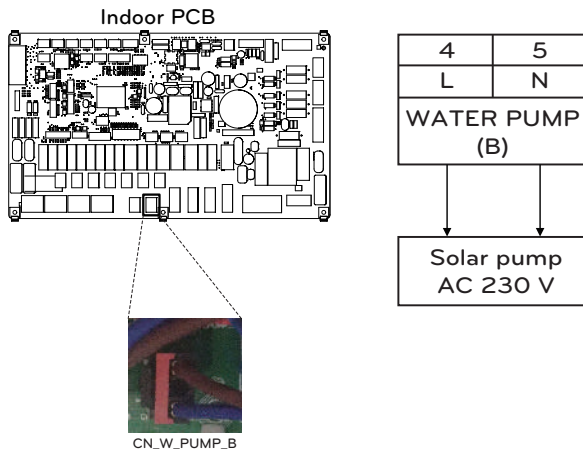

(For Split R32 Indoor unit 4 Series, For Split R410A Indoor unit 3 Series)

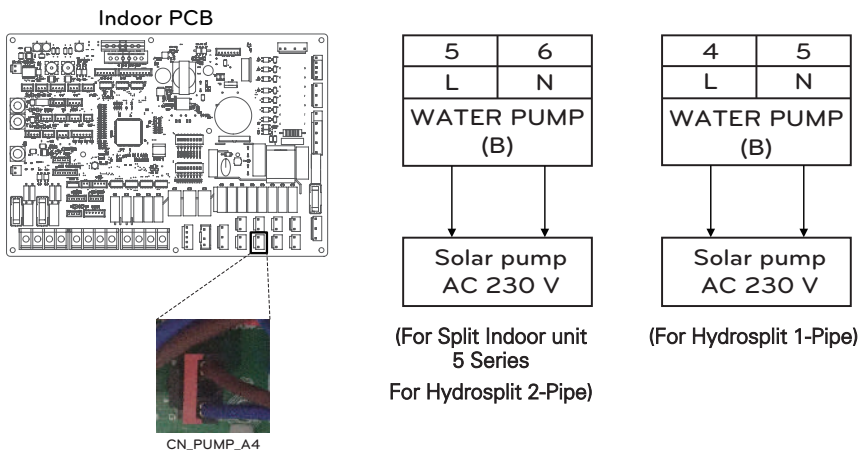

External pump

External pump can be required when the room to take floor heating is too large or not well-insulated.(potential free) Also, External pump is installed with buffer tank to retain sufficient capacity.

How to wire external pump

Follow below procedures step 1 ~ step 3.

Step 1. Check if the power of the unit is turned off.

Step 2. Disassemble front panels and distinguish terminal block in Indoor PCB.

Step 3. Connect signal cable to terminal block fully.

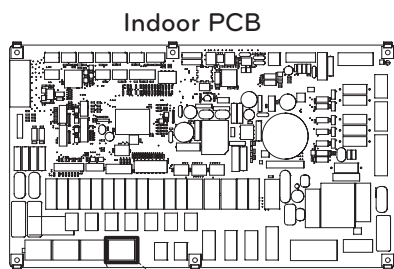

TB_EXT_PUMP



External pump
(Voltage free)

(For Split R32 Indoor unit 4 Series,
For Split R410A Indoor unit 3 Series)

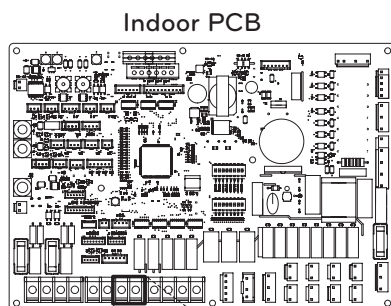

PUMP A2

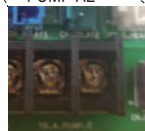

External pump
(Voltage free)

(For Split Indoor unit 5 Series, For Hydrosplit)

Wi-fi Modem

Wi-fi modem enables remote system operation from smartphone. Available functions include selection of on/off, operation mode, DHW heating, temperature setup and weekly scheduling etc. For detailed instructions, refer to the manual included in the accessories.

How to wire Wi-fi Modem

[Parts of Wi-fi modem]



Wi-fi modem body

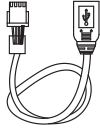

USB Cable

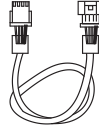

Extension Cable

※ Extension cable for Wi-Fi Modem : PWYREW000 (Sold Separately)

Follow below procedures step 1 ~ step 5.

Step 1. Check if the power of the unit is turned off.

Step 2. Disassemble front panels and distinguish control box(Indoor) of the unit.

Step 3. Connect the USB cable to the indoor unit PCB (CN_WF ; Blue) until it clicks into place.

Step 4. Connect the Wi-Fi modem to the USB cable fully.

Step 5. Refer to the image below to install the Wi-Fi modem in the marked position.

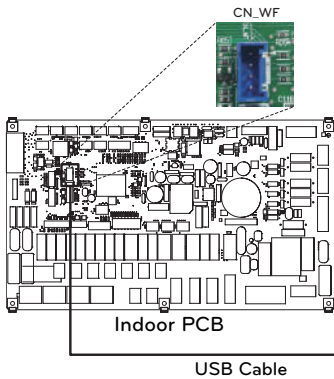

(For Split R32 Indoor unit 4 Series,
For Split R410A Indoor unit 3 Series)

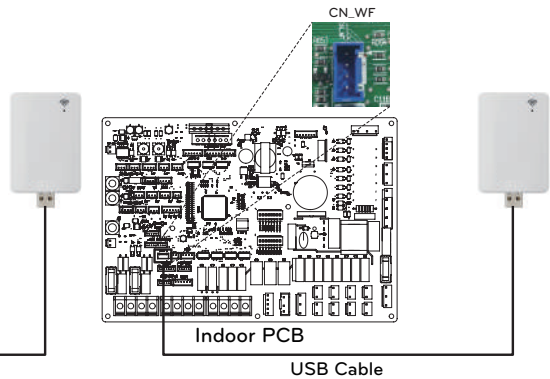

(For Split Indoor unit 5 Series, For Hydrosplit)

Smart Grid (For Split R32 Indoor unit 4 Series, For Split R410A Indoor unit 3 Series)

This product provides SG function for users. It enables to stop internal operation(Heating / DHW) and control target temperature depending on input signal from power provider.

How to wire smart grid

Follow below procedures step 1 ~ step 3.

Step 1. Check if the power of the unit is turned off.

Step 2. Disassemble front panels and distinguish terminal block in Indoor PCB.

Step 3. Connect signal cable to terminal block in PCB (TB_SG2, TB_SG1) fully as shown below.

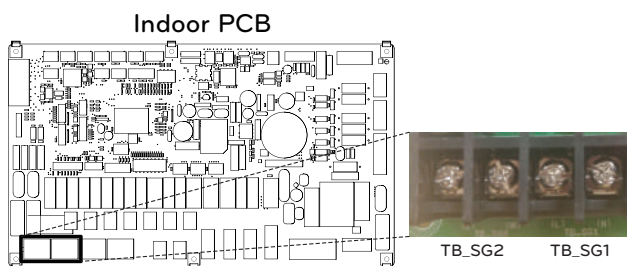

Heating and DHW Operation depend on input signal(SG1 / SG2)

Status display	Input Signal		Command	Cost (Electric)	Operation	
	SG1	SG2			Heating	Domestic How Water
SGN	Open	Open	Normal Operation	Normal Price	Maintain operation status	Maintain operation status
SG1	Close	Open	Operation Off (Utility lock)	High Price	Forced internal operation off	Forced internal operation off
SG2	Open	Close	Operation On Recommend	Low Price	Target temperature change automatically depend on SG Mode value in installer setting - Step 0 : maintain target temperature - Step 1 : increase 2 °C from target temperature - Step 2 : increase 5 °C from target temperature	Target temperature change automatically depend on SG Mode value in install setting - Step 0 : increase 5 °C from target temperature - Step 1 : increase 5 °C from target temperature - Step 2 : increase 7 °C from target temperature
SG3	Close	Close	Operation On Command	Very Low Price	Maintain operation status	Target temperature change automatically to 80 °C

Energy State (For Split Indoor unit 5 Series, For Hydrosplit)

This product provides energy states that enable customers to use as much as possible of their own renewable energy. It can shift setpoints depending on input signal from Energy Storage System (ESS) or from any other third-party device using Modbus RTU or Digital 230V inputs.

Available Energy States

There are 8 energy states available. 4 fixed and 4 customizable - each with the possibility to enhance self-consumption of renewable energy.

Energy state	Command	Battery State of charge	Operation (standard setting)					
			Heating		Cooling		Domestic Hot Water	
			Setting	Range	Setting	Range	Setting	Range
1	Operation Off (Utility lock)	Low	Forced internal operation off	Fixed	Forced internal operation off	Fixed	Forced internal operation off	Fixed
2	Normal Operation	Normal	Maintain operation status	Fixed	Maintain operation status	Fixed	Maintain operation status	Fixed
3	Operation On Recommend	High	Increase 2 °C from target temperature	Fixed	Maintain operation Status	Fixed	Increase 5 °C from target temperature	Fixed
4	Operation On Recommend	Very High	Maintain operation status	Fixed	Maintain operation status	Fixed	DHW Target 80 °C	Fixed
5	Operation On Command	Very High	Increase from target temperature	0/+30 (Default : +5)	Decrease from target temperature	0/-30 (Default : -5)	Increase from target temperature	0/+50 (Default : +30)
6	Operation On Recommend	High	Increase from target temperature	0/+30 (Default : +2)	Decrease from target temperature	0/-30 (Default : -2)	Increase from target temperature	0/+50 (Default : +10)
7	Operation Save	Low	Decrease from target temperature	0/-30 (Default : -2)	Increase from target temperature	0/+30 (Default : +2)	Decrease from Target Temperature	0/-50 (Default : 0)
8	Operation Super Save	Very Low	Decrease from target temperature	0/-30 (Default : -5)	Increase from target temperature	0/+30 (Default : +5)	Decrease from Target Temperature	0/-50 (Default : 0)

Digital Input for energy saving (ESS, Smart Grid) (For Split Indoor unit 5 Series, For Hydrosplit)

This product provides two digital inputs (ES1 / ES2) that can be used to switch between energy states when not using Modbus RTU (CN-COM).

Available Energy States

There are 8 energy states available in total. Four different states can be triggered using the 230V-inputs – by default Energy states 1-4.

With the digital input assignment in the menu 'Energy state/Digital input assignment' of the control pane, different Energy states can be selected for Signals 0:1 and 1:1.

0:0 is always linked with ES2 (Normal operation) and 1:0 is always linked with ES1 (Operation off/Utility lock).

How to set Digital input signal

Follow below procedures step 1 ~ step 3.

Step 1. Check if the power of the unit is turned off.

Step 2. Disassemble front panels and distinguish terminal block in Indoor PCB.

Step 3. Connect signal cable to terminal block in PCB (ES2, ES1) fully as shown below.

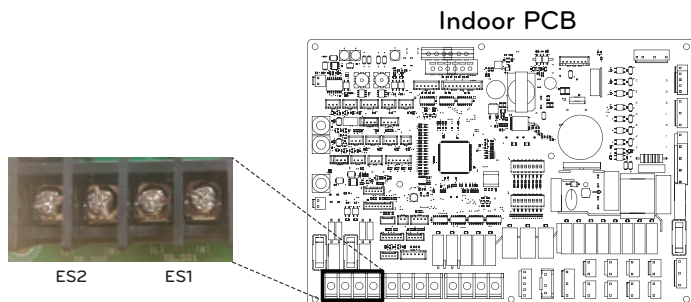

Energy state depending on input signal (ES1 / ES2)

Input Signal		Output state	
ES1	ES2	Default	Range
0	0	ES2	fixed
1	0	ES1	
0	1	ES3	ES3-ES8
1	1	ES4	

2Way Valve

2way valve is required to control water flow while cooling operation. Role of 2way valve is to cut off water flow into under floor loop in cooling mode when fan coil unit is equipped for cooling operation.

General Information

THERMA V. supports following 2way valve.

Type	Power	Operating Mode	Supported
NO 2-wire (1)	230 V AC	Energize : Valve Closing	Yes
		De-Energize : Valve Opening	
NC 2-wire (2)	230 V AC	Energize : Valve Closing	Yes
		De-Energize : Valve Opening	

(1) : Normal Open type. When electric power is NOT supplied, the valve is open. (When electric power is supplied, the valve is closed.)

(2) : Normal Closed type. When electric power is NOT supplied, the valve is closed. (When electric power is supplied, the valve is open.)

How to Wire 2Way Valve

Follow below procedures Step 1 ~ Step 2.

Step 1. Uncover front cover of the unit.

Step 2. Find terminal block and connect wire as below.

For Split R32 Indoor unit 4 Series,
For Split R410A Indoor unit 3 Series
For Hydrosplit 1-Pipe

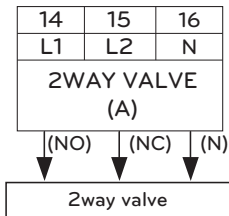

For Split Indoor unit 5 Series,
For Hydrosplit 2-Pipe

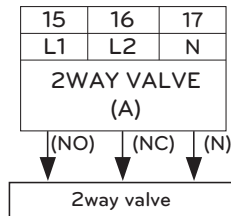

CAUTION

Dew Condensation

- Wrong wiring can yield dew condensation on the floor. If radiator is connected at the under floor water loop, dew condensation can be occurred on the surface of the radiator.

WARNING

Wiring

- Normal Open type should be connected to wire (NO) and wire (N) for valve opening in cooling mode.
- Normal closed type should be connected to wire (NC) and wire (N) for valve closing in cooling mode.

(NO) : Live signal (for Normal Open type) from PCB to 2way valve.

(NC) : Live signal (for Normal Closed type) from PCB to 2way valve.

(N) : Neutral signal from PCB to 2way valve.

Final Check

- Flow direction :
 - Water should not flow into under floor loop in cooling mode.
 - To verify the flow direction, check temperature at the water inlet of the under floor loop.
 - If correctly wired, this temperatures should not be reached below 16 °C in cooling mode.

3Way Valve(A)

3Way Valve(A) is required to operate DHW water tank. Role of 3way valve is flow switching between under floor heating loop and water tank heating loop. Plus, it is required to operate 3rd party boiler.

General Information

THERMAV. supports following 3way valve.

Type	Power	Operating Mode	Supported
SPDT 3-wire (1)	220-240 V~	Selecting "Flow A" between "Flow A" and "Flow B" (2)	Yes
		Selecting "Flow B" between "Flow A" and "Flow B" (3)	Yes

(1) : SPDT = Single Pole Double Throw. Three wires consist of Live1 (for selecting Flow A), Live 2 (for selecting Flow B), and Neutral (for common).

(2) : Flow A means 'water flow from the unit to under floor water circuit.'

(3) : Flow B means 'water flow from the unit to DHW water tank.'

How to wire 3way valve(A)

Follow below procedures Step 1 ~ Step 2.

Step 1. Uncover front cover of the unit.

Step 2. Find terminal block and connect wire as below.

For Split R32 Indoor unit 4 Series,
For Split R410A Indoor unit 3 Series
For Hydrosplit 1-Pipe

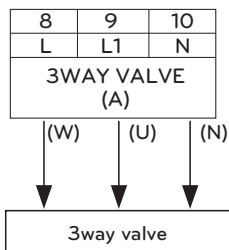

For Split Indoor unit 5 Series,
For Hydrosplit 2-Pipe

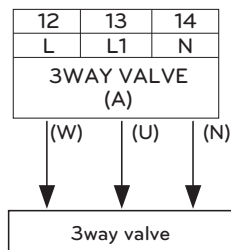

WARNING

- 3way valve should select water tank loop when electric power is supplied to wire (W) and wire (N).
- 3way valve should select under floor loop when electric power is supplied to wire (U) and wire (N).

(W) : Live signal (Water tank heating) from PCB to 3way valve

(U) : Live signal (Under floor heating) from PCB to 3way valve

(N) : Neutral signal from PCB to 3way valve

3Way Valve(B)

3way valve(B) is required to operate Solar thermal system. Role of 3way valve is flow switching between open and close mode of the solar circuit.

General Information

THERMA V. supports following 3way valve.

Type	Power	Operating Mode	Supported
SPDT 3-wire (1)	220-240 V~	Selecting "Flow A" between "Flow A" and "Flow B" (2)	Yes
		Selecting "Flow B" between "Flow A" and "Flow B" (3)	Yes

(1) : SPDT = Single Pole Double Throw. Three wires consist of Live1 (for selecting Flow A), Live 2(for selecting Flow B), and Neutral (for common).

(2) : Flow B means 'heat source toward solar panel repeatedly'. (close mode of circuit)

(3) : Flow A means 'heat source flow from solar panel to DHW tank in solar circuit'.
(open mode of circuit)

How to wire 3way valve(B)

Follow below procedures Step 1 ~ Step 2.

Step 1. Uncover front cover of the unit.

Step 2. Find terminal block and connect wire as below.

For Split R32 Indoor unit 4 Series,
For Split R410A Indoor unit 3 Series
For Hydrosplit 1-Pipe

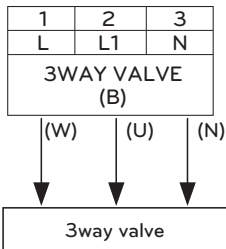

For Split Indoor unit 5 Series,
For Hydrosplit 2-Pipe

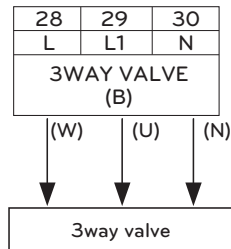

⚠ WARNING

- 3way valve should select "close solar circuit" when electric power is supplied to wire (W) and wire (N).
- 3way valve should select "open solar circuit" when electric power is supplied to wire (U) and wire (N).

(W) : Live signal (close solar circuit) from PCB to 3way valve

(U) : Live signal (open solar circuit) from PCB to 3way valve

(N) : Neutral signal from PCB to 3way valve

Final check

No.	Check point	Description
1	Connection of Water Inlet/Outlet	<ul style="list-style-type: none"> - Check if the shut-off valves should be assembled with Water inlet and outlet pipe of the unit - Check the location of the water inlet/outlet water pipe
2	Hydraulic pressure	<ul style="list-style-type: none"> - Check the pressure of supplying water by using pressure gauge inside the unit - Pressure of Supplying water should be Under 3.0 bar approximately
3	Water pump capacity	<ul style="list-style-type: none"> - To secure enough water flow rate, do not set water pump capacity as Minimum. - It can lead unexpected flow rate error CH14. (Refer to Chapter 4 'Water Piping and Water Circuit Connection')
4	Transmission line and power source wiring	<ul style="list-style-type: none"> - Check if Transmission line and power source wiring are separated from each other. - If it is not, electronic noise may occur from the power source.
5	The power cord specifications	<ul style="list-style-type: none"> - Check the power cord specifications (Refer to Chapter 4 'Connecting Cables')
6	3Way Valve	<ul style="list-style-type: none"> - Water should flow from Water outlet of the unit to sanitary tank Water inlet when sanitary tank heating is selected. - To verify the flow direction, Make sure that the water outlet temperature of the unit and water inlet temperature of sanitary Water tank are similar
7	2Way Valve	<ul style="list-style-type: none"> - Water should not flow into under floor loop in cooling mode. - To verify the flow direction, check temperature at the water inlet of the under floor loop. - If correctly wired, this temperatures should not be reached below 16 °C in cooling mode.
8	Air Vent	<ul style="list-style-type: none"> - Air-vent must be located highest level of Water pipe system - It should be installed at the point which is easy to service. - It takes some times to remove air in the water system if air purge is not performed sufficiently it may occur CH14 error. (refer to Chapter 4 'Water Charging')

CONFIGURATION

As **THERMAV** is designed to satisfy various installation environment, it is important to set up system correctly. If not configured correctly, improper operation or degrade of performance can be expected.

DIP Switch Setting (For Split R32 Indoor unit 4 Series, For Split R410A Indoor unit 3 Series)

CAUTION

Turn off electric power supply before setting DIP switch

- Whenever adjusting DIP switch, turn off electric power supply to avoid electric shock.





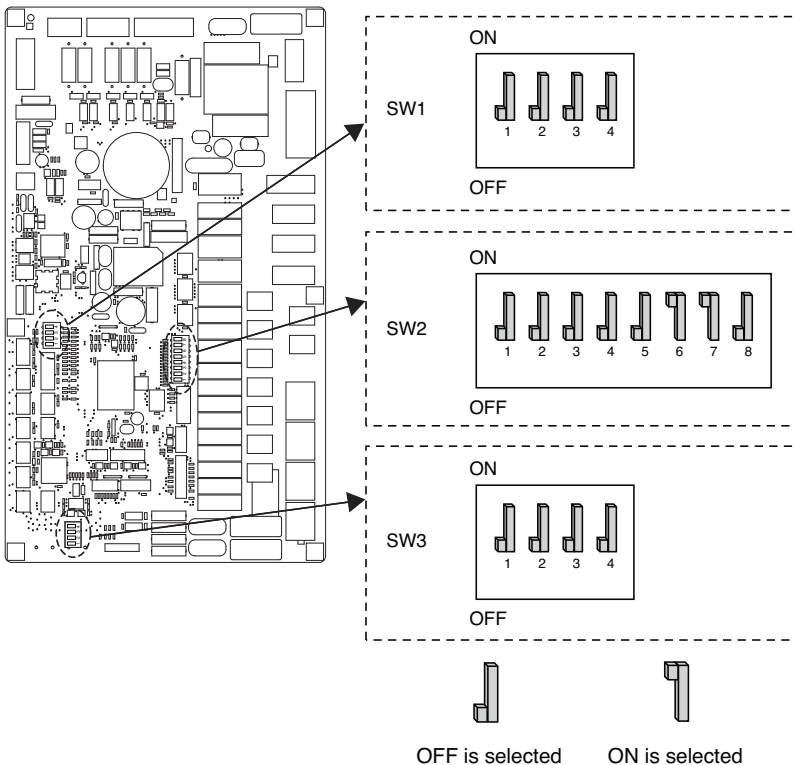



























General Information

Indoor PCB



DIP Switch Information













Option Switch 2

Description	Setting		Default
Group control	1 	As Master	1 
	1 	As Slave	
Accessory installation information	2  3 	Heat pump is installed (Heating(Cooling) circuit only)	2  3 
	2  3 	Heat pump + DHW tank is installed	
	2  3 	Heat pump + DHW tank + Solar thermal system is installed	
	2  3 	Unused	
Cycle	4 	Heating Only	4 
	4 	Heating & Cooling	
Flow Switch (Flow Sensor) Detection	5 	Always	5 
	5 	While water pump is on	
Selecting Backup Heater capacity	6  7 	Electric Heater is not used	6  7 
	6  7 	1Ø model : Half capacity is used 3Ø model : 1/3 capacity is used	
	6  7 	Unused	
	6  7 	Full capacity is used	
Thermostat Installation Information	8 	Thermostat is NOT installed	8 
	8 	Thermostat is installed	













**CAUTION**

- When an external pump or other boiler is installed DIP switch No.5 setting change(Off → On) need to be added

Option Switch 1

Description	Setting		Default
MODBUS	1 	As Master (LG extensions modules)	1 
	1 	As Slave (3rd party controller)	
MODBUS Communication Type	2 	Common 3 rd party	2 
	2 	SIEMENS	
-	 3	 3	3 
-	 4	 4	4 

Option Switch 3

Description	Setting		Default
Remote Room Air Sensor (Accessory)	1 	Remote sensor is not installed	1 
	1 	Remote sensor is installed	
Antifreeze Agent *	2 	Antifreeze agent is not used	2 
	2 	Antifreeze agent is used **	
-	 3	 3	3 
-	 4	 4	4 

* This function is available for the R32 models only.

** Possibility to allow colder water temperature by setting. Bridge as CN_FLOW2 on PCB must be dis-connected to enable setting.

Outdoor PCB (5, 7, 9 kW)

U36A Chassis (For R32)

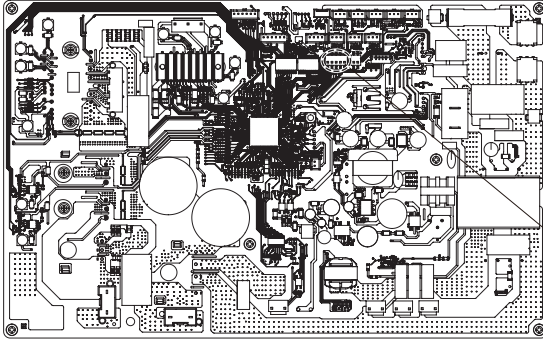

OFF is selected



ON is selected

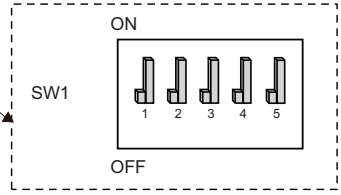

U36A Chassis (For R410A)

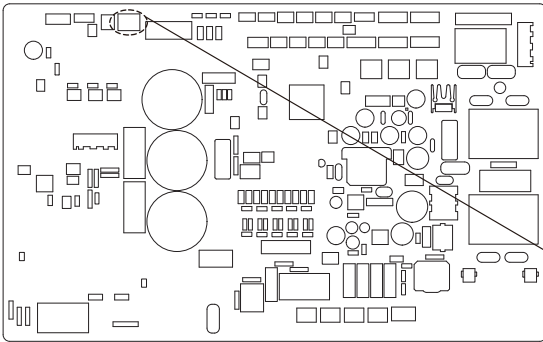

OFF is selected



ON is selected

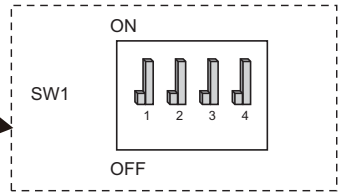

Outdoor PCB (12, 14, 16 kW)

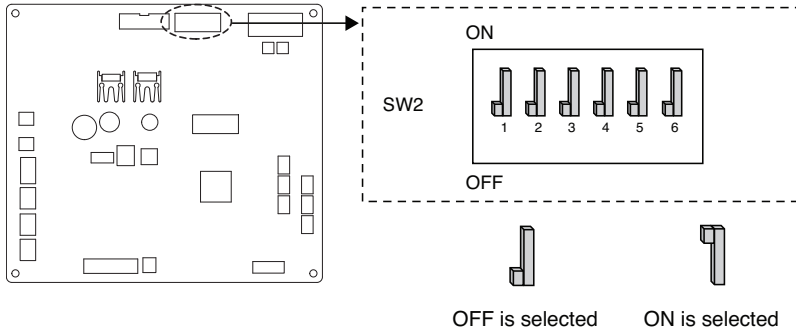

DIP Switch Information

Description	Setting		Default
Low Noise Mode	2	Always Mode - Maintain low noise mode for target temperature	2
	2	ON/OFF Partial mode - Escape low noise mode for target temperature	
Peak Control	3	Max Mode	3
	3	Peak Control - To limit maximum current (Power saving)	

* Only DIP-switch no. 2 and no.3 has a function. Others have no function.

* When setting the limited low noise mode, Mode can be exited to secure capacity after operating for a certain time.

NOTE

* Input current value can be limited by DIP Switch operation.

Capacity	Mode	Max Mode Running Current(A)	Peak Control Mode Running Current(A)
1Ø 5,7,9 kW	Cooling	23	17
	Heating	23	17
1Ø 12,14,16 kW	Cooling	35	25
	Heating	35	27
3Ø 12,14,16 kW	Cooling	15	10
	Heating	15	12

DIP Switch Setting (For Split Indoor unit 5 Series, For Hydrosplit)

CAUTION

Turn off electric power supply before setting DIP switch

- Whenever adjusting DIP switch, turn off electric power supply to avoid electric shock.





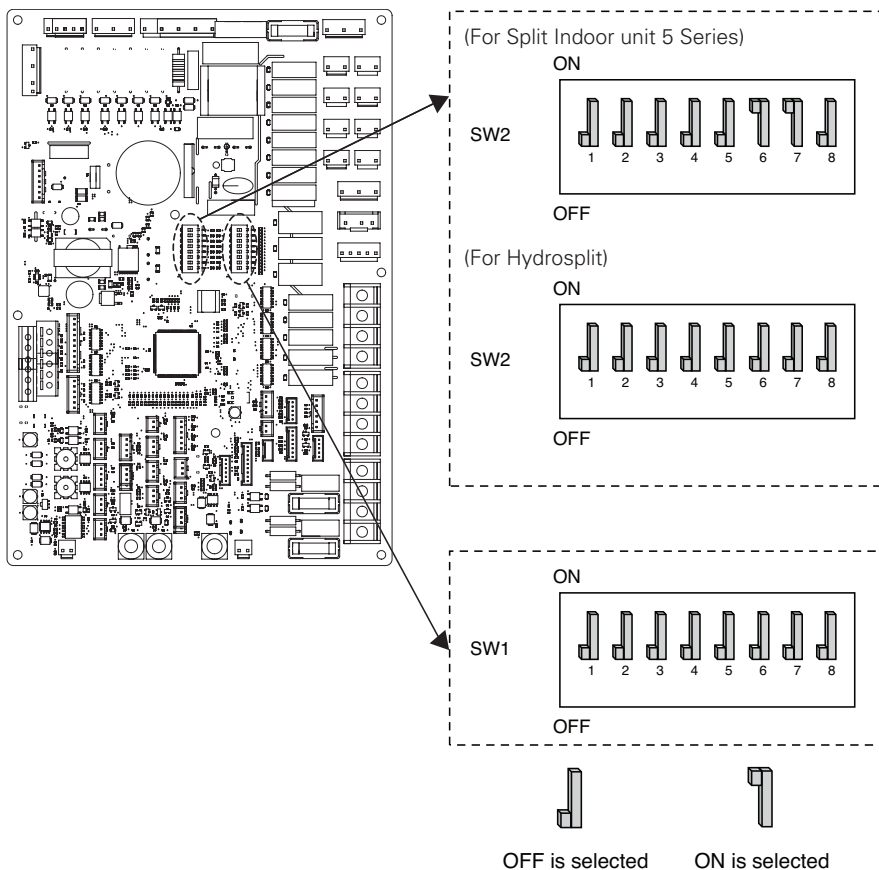



























General Information

Indoor PCB











DIP Switch Information

Option Switch 2

Description	Setting		Default
Group Control	1 	As Master	1 
	1 	As Slave	
Accessory installation information	2  3 	Heat pump is installed (Heating(Cooling) circuit only)	2  3 
	2  3 	Heat pump + DHW tank is installed	
	2  3 	Heat pump + DHW tank + Solar thermal system is installed	
Cycle	4 	Heating Only	4 
	4 	Heating & Cooling	
Room Air Sensor	5 	Room Air Sensor is not installed	5 
	5 	Room Air Sensor is installed	
Selecting Backup heater capacity	6  7 	For Split Indoor unit 5 Series : Electric heater is not used For Hydrosplit : Electric heater is not used	- For Split Indoor unit 5 Series 6  7  - For Hydrosplit 6  7 
	6  7 	For Split Indoor unit 5 Series : Half capacity is used For Hydrosplit : Full capacity is used	
	6  7 	For Split Indoor unit 5 Series : Reserved For Hydrosplit : Electric heater is not used	
	6  7 	For Split Indoor unit 5 Series : Full capacity is used For Hydrosplit : Electric heater is not used	
Thermostat installation information	8 	Thermostat is NOT installed	8 
	8 	Thermostat is installed	

Option Switch 1



Description	Setting		Default
MODBUS Communication Type	1 	As Master (LG extension modules)	1 
	1 	As Slave (3rd party controller)	
MODBUS Function	2 	REGINE	2 
	2 	Unified Open Protocol	
Antifreeze Agent	8 	Antifreeze agent is not used	8 
	8 	Antifreeze agent is used *	

* Possibility to allow colder water temperature by setting.
Bridge at CN_ANTI_SW must be dis-connected to enable setting.

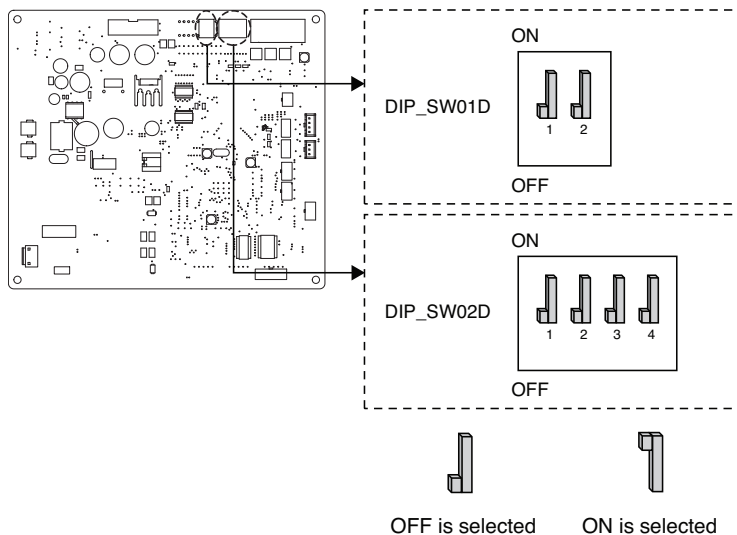







Outdoor PCB (12, 14, 16 kW)



(Option Switch 1)

Description	Setting		Default
Low Noise Mode	2 	Always Mode - Maintain low noise mode for target temperature	2 
	2 	ON/OFF Partial mode - Escape low noise mode for target temperature	

(Option Switch 2)

Description	Setting		Default
Peak Control	 1  2	Max Mode	 1  2
	 1  2	Peak Control Step 1 - To limit maximum current (Power saving)	
	 1  2	Peak Control Step 2 - To limit maximum current (Power saving)	

* Only the switch in the table has a function. Others have no function.

* When setting the on/off partial mode, Mode can be exited to secure capacity after operating for a certain time.

NOTE

* Input current value can be limited by DIP Switch operation.

Capacity	Mode	Max Mode Running Current(A)	Peak Control Mode Running Current(A)	
			Step 1	Step 2
1Ø 12,14,16 kW	Cooling	35	25	22
	Heating	35	25	22
3Ø 12,14,16 kW	Cooling	15	10	8
	Heating	15	10	8

NOTE**Emergency Operation****• Definition of terms**

- Trouble : a problem which can stop system operation, and can be resumed temporarily under limited operation without certificated professional's assist.
- Error : problem which can stop system operation, and can be resumed ONLY after certificated professional's check.
- Emergency mode : temporary heating operation while system met Trouble.

• Objective of introducing 'Trouble'

- Not like airconditioning product, Air-to-Water heat pump is generally operation in whole winter season without any system stopping.
- If system found some problem, which is not critical to system operating for yielding heating energy, the system can temporarily continue in emergency mode operation with end user's decision.

• Classified Trouble

- Trouble is classified two levels according to the seriousness of the problem : Slight Trouble and Heavy trouble
- Slight Trouble : a problem is found inside the unit. In most case, this trouble is concerned with sensor problems. The outdoor unit is operating under emergency mode operation condition which is configured by DIP switch No. 4 of the unit PCB.
- Heavy trouble : a problem is found inside the outdoor unit. As the outdoor unit has problem, the emergency mode operation is performed by electric heater located in the unit.
- Option Trouble : a problem is found for option operation such as water tank heating. In this trouble, the troubled option is assumed as if it is not installed at the system.

• When the AWHP has any trouble,

(1) If there is not a function to judge possibility of operation :

Once an error occurs mainly in indoor unit, AWHP stops. On the other hand, Remocon allows the product to activate On/ Off operation. (On : emergency operation)

- Slight / Heavy trouble : Heating Operable only
- Critical trouble : Full stop
- Treatment priority : Critical>Heavy>Slight

(2) If there is a function to judge possibility of operation :

Depending on the status of slight / heavy / critical trouble, pop-up phrase is guided separately on display.

- Slight trouble : Heating/Cooling Operable
- Heavy trouble : Heating Operable only
- Critical trouble : Service center request

AWHP operates when user pressed OK button on pop-up window.

NOTE**• Duplicated trouble : Option trouble with slight or heavy trouble**

- If option trouble is occurred with slight (or heavy) trouble at the same time, the system puts higher priority to slight (or heavy) trouble and operates as if slight (or heavy) trouble is occurred.
- Therefore, sometimes DHW heating can be impossible in emergency operation mode. When DHW is not warming up while emergency operation, please check if DHW sensor and related wiring are all Ok.

• Emergency operation is not automatically restarted after main electricity power is reset.

- In normal condition, the product operating information is restored and automatically restarted after main electricity power is reset.
- But in emergency operation, automatic re-start is prohibited to protect the product.
- Therefore, user must restart the product after power reset when emergency operation has been running.

SERVICE SETTING

How to enter service setting

To enter the menu displayed at the bottom, you need to enter the service setting menu as follows.

- In the menu screen, press [←,→(left/right)] button to select the setting category, and press [OK] button to move to the setting list.
- In the setting list, select the service setting category, and press [OK] button to move to the service setting list.

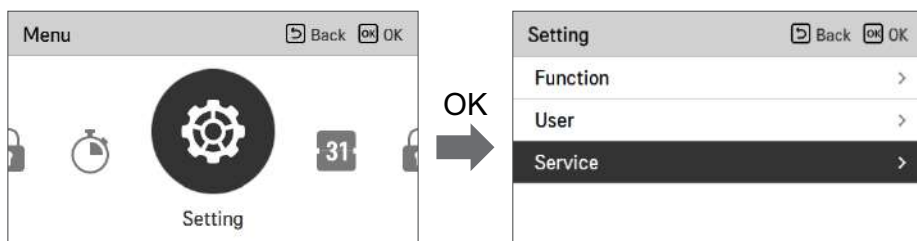

Service setting

- You can set the product service functions.
- Some functions may not be displayed/operated in some product types.

Menu	Description
Service contact	Check and input the service center phone number that you can call when there is service issue.
Model information	View product and capacity information
RMC Version Information	Check the remote controller model name and software version.
Open Source License	View the remote controller's open source license.

Service contact

Check and input the service center phone number that you can call when there is service issue.

- In the service setting list, select the service contact point and press [OK] button to move to the detail screen.
- While “edit” button is selected, press [OK] button to move to the edit screen, change it, and press [OK] button to change the service contact point.

Service	Back	OK
Service Contact	>	
Model Information	>	
RMC Version Information	>	
Open Source License	>	



Service Contact	Back	OK
Telephone +1544-7777		
Edit		



Service Contact	Back	OK
Telephone		
+	1	5 4 4 - 7 7
7 7		

Model information

Check product and capacity information to which the remote controller is connected.

- In the service setting list, select model information category, and press [OK] button to move to the detail screen.
- The Model information
 - Depending on the model you own, the model name and serial number may not be displayed.
 - The displayed model name is the factory model name.
- The unit capacity
 - $1 \text{ kWh} = 1 \text{ kBtu} * 0.29307$
 - kWh is the result calculated based on Btu, There may be a small difference between calculated and actual capacity.
 - Ex) If the unit capacity is 18 kBtu, it is displayed as 5 kWh.

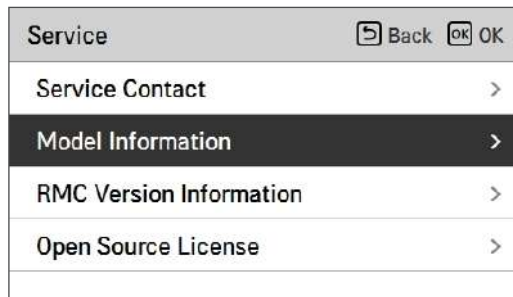

RMC version Information

View the remote controller software version.

- In the service setting list, select the RMC version information and press [OK] button to move to the detail screen

Service	Back	OK
Service Contact		>
Model Information		>
RMC Version Information		>
Open Source License		>



RMC Version Information	Back
SW Version 3.03.1a	

Open source license

View the remote controller's open source license.

- In the service setting list, select the open source license category, and press [OK] button to move to the detail screen.

Service	Back	OK
Service Contact	>	
Model Information	>	
RMC Version Information	>	
Open Source License	>	



Open Source License		Back
LGE Open Source Software Notice		
Product Type	HVAC WIRED REMOTE CONTR	
Model Number/Range	RS3 Wired Remote Controller	1/401
Those products identified by the Product Type and Model Range above from LG Electronics, Inc. ("LGE") contain the open source software detailed below. Please refer to the		

INSTALLER SETTING

How to enter installer setting

CAUTION

The installer setting mode is the mode to set the remote controller's detail function. If the installer setting mode is incorrectly set, it may cause product failure, user's injury, or property damage. It must be set by the installation specialist with the installation license, and if it is installed or changed without installation license, all problems caused will be the responsibility of the installer, and may void the LG warranty.

- In the menu screen, press [,<,>(left/right)] button to select the setting category, and press [^ (up)] button for 3 seconds to enter the password input screen for the installer setting.
- Input the password and press [OK] button to move to the installer setting list.

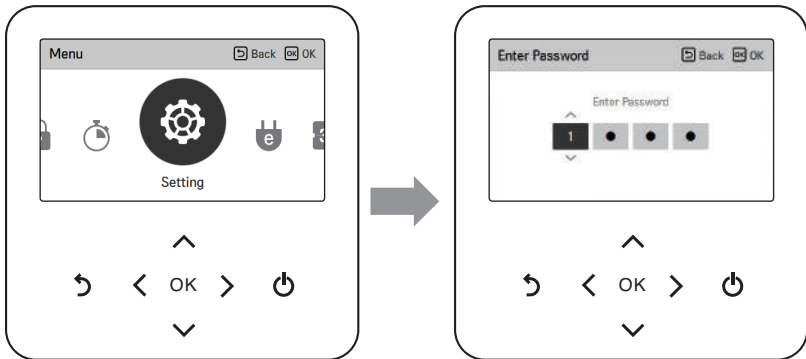

※ Installer setting password

Main screen → menu → setting → service → RMC version information → SW Version

Example) SW version : 1.00.1 a

In the above case, the password is 1001.

NOTE

Some categories of the installer setting menu may not be available depending on the product function or the menu name may be different.

Installer setting (For Split R32 Indoor unit 4 Series, For Split R410A Indoor unit 3 Series)

- You can set the product user functions.
- Some functions may not be displayed/operated in some product types.

Function	Description
3 Minutes Delay	Factory use only
Select Temperature Sensor	Selection for setting temperature as air temperature or leaving water temperature or air+leaving water temperature
Dry Contact Mode	Dry contact function is the function that can be used only when the dry contact devices is separately purchased and installed.
Central Control address	When connecting the central control, set the central control address of the unit.
Pump Test run	Water pump test run
Air cooling set temp.	Adjusting range of 'Setting Air Temperature' in cooling mode
Water cooling set temp.	Adjusting range of 'Setting Leaving Water Temperature' in cooling mode
Air heating set temp.	Adjusting range of 'Setting Air Temperature' in heating mode
Water heating set temp.	Adjusting range of 'Setting Heating Flow Temperature' in heating mode
DHW Set Temp.	Setting DHW set temperature
Screed drying	This function controls floor heating to a specific temperature for a certain period of time to cure floor cement.
Heater on temperature	Setting outdoor air temperature where half capacity of backup heater starts operation.
Water supply off temp. during cooling	Determine the leaving water temperature which blocks the flow into underfloor coil in cooling mode. This function is used for preventing condensation on the floor in cooling mode
Tank disinfection setting 1	Setting start/maintain time for disinfection
Tank disinfection setting 2	Setting disinfection temperature
Tank setting 1	Setting minimum and maximum temperature using heat pump cycle for DHW heating
Tank setting 2	Setting temperature hysteresis and heating priority (DHW heating or floor heating)
Heater priority	Determine usage of backup heater and booster heater
DHW time setting	Determine follow time duration : operation time of domestic hot water tank heating, stop time of domestic hot water tank heating, and delay time of DHW tank heater operating
TH on/off Variable, heating air	Heating air temperature TH On / Off Type setting
TH on/off Variable, heating Water	Heating Water Outlet Temperature TH On / Off Type

Function	Description
TH on/off Variable, cooling air	Cooling air temperature TH On / Off Type setting
TH on/off Variable, cooling Water	Cooling Water Outlet Temperature TH On / Off Type
Heating temp.	At the water control in heating mode, the control reference water temperature position setting
Cooling temp.	At the water control in cooling mode, the control reference water temperature position setting
Pump setting in heating	Set water pump on/off interval option during thermo off condition in heating mode
Pump setting in cooling	Set water pump on/off interval option during thermo off condition in cooling mode
Forced operation	Water pump off After 20 consecutive hours, disable / enable the logic that drives the water pump by itself
CN_CC	It is the function to set whether to install (use) Dry Contact. (It is not a function for Dry Contact installation, but it is a function to set the usage of the unit's CN_CC port.)
Pump frequency setting(RPM)	Function to change Water Pump RPM
Pump Capacity	Function to change Water Pump Capacity
Smart Grid(SG)	Select whether to use or not use the SG Mode function of the product, set the operation option value in SG1 step.
Seasonal auto temp.	Set the operating temperature in Seasonal Auto mode
Modbus Address	It is function to set the address of the Modbus device that is externally linked to the product. Modbus address setting function is available from indoor unit.
CN_EXT	Function to set external input and output control according to DI / DO set by customer using dry contact port of indoor unit. Determine the use of the contact port (CN_EXT) mounted on the indoor unit PCB
Anti-freezing Temperature	This function is to apply an offset to the freezing temperature of the freeze protection logic when using antifreeze mode
Add Zone	Install additional valve in product to control additional operation area
Use External Pump	Set up to control an external water pump
3rd Party Boiler	Configuration to control 3rd party boiler
Meter Interface	When installing the meter interface to measure energy / calorie in the product, set unit spec for each port
Pump Prerun/Overrun	Set to reach the optimum flow rate by circulating the heating water with the water pump before heat exchange. After the operation stop, additional water pump is activated to circulate the heating water.
Solar Thermal System	Function to set operation reference value in Solar Thermal System.
Current flow rate	Function to check the current flow rate.
Data logging	Display error history of connected unit
Password Initialization	It is the function to initialize (0000) the password when you forgot the password set in the remote controller.

Overview settings

Menu Structure

Menu		
Sub function		
Service contact	159
Model information	160
RMC version Information	161
Open source license	162
Installer		
3 Minutes Delay	168
Select Temperature Sensor	169
Dry Contact Mode	170
Central Control Address	172
Pump Test run	172
Air cooling set temp.	173
Water cooling set temp.	174
Air heating set temp.	175
Water heating set temp.	176
DHW set temp.	177
Screed drying	178
Heater on temperature	180
Water supply off temp. during cooling	182
Tank disinfection setting 1, 2	184
Tank setting 1	185
Tank setting 2	186
Heater priority	188
DHW time setting	189
TH on/off Variable, heating air	190
TH on/off Variable, heating water	191

→	TH on/off Variable, cooling air	192
→	TH on/off Variable, cooling water	193
→	Heating temp. setting	194
→	Cooling temp. setting	195
→	Pump setting in heating	196
→	Pump setting in cooling	197
→	LG Therma V Configuration	198
→	Forced operation	199
→	CN_CC	200
→	Pump frequency setting (RPM)	201
→	Pump Capacity	202
→	Smart Grid(SG)	203
→	Power Supply Blockage (Smart Grid)	204
→	Seasonal auto temp.	205
→	Modbus Address	207
→	CN_EXT	208
→	Anti-freezing Temperature	209
→	Add Zone	210
→	Use External Pump	211
→	3 rd Party Boiler	212
→	Meter Interface	213
→	Pump Prerun/Overrun	214
→	Solar Thermal System	215
→	Current flow rate	217
→	Data logging	218
→	Password Initialization	219

3 Minutes Delay

Temporarily eliminates the 3-minute delay function of the outdoor unit Comp

- Factory use only

- In the installer setting list, select 3 Minutes Delay category, and press [OK] button to move to the detail screen.

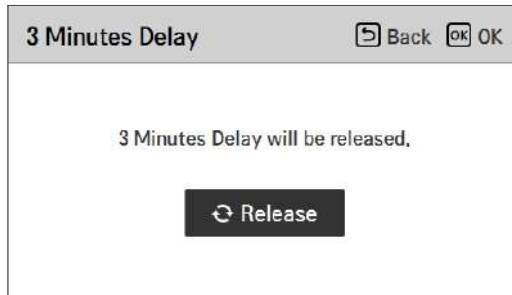
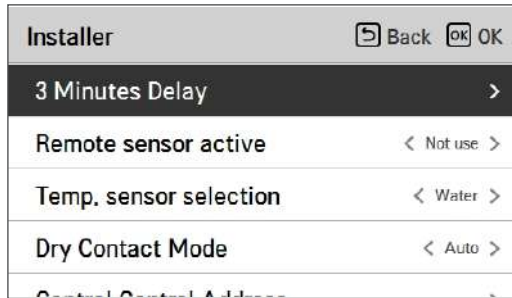

Select Temperature Sensor

The product can be operated according to air temperature or water temperature. The selection for setting temperature as air temperature or water temperature is determined.

- In the installer setting list, Select Temperature Sensor category, and press [OK] button to move to the detail screen.

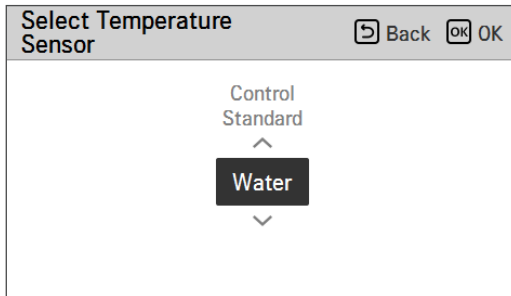
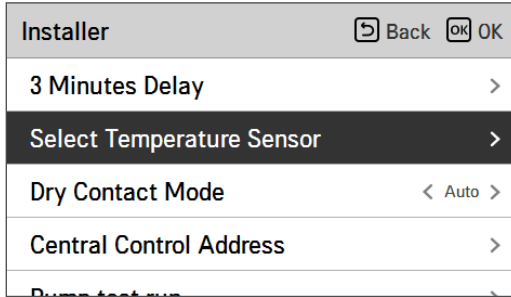

Value		
Water (Default)	Air	Air+Water

NOTE

Air temperature as setting temperature is ONLY available when Remote Air Sensor Connection is enabled and Remote Air Sensor Connection is set as 02.

Dry Contact Mode

Dry contact function is the function that can be used only when the dry contact devices is separately purchased and installed.

- Change setting values using [<,>(left/right)] button.

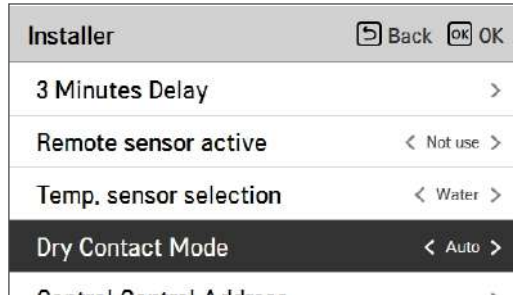

Value	Description
Auto (Default)	Automatically operation ON with release hard lock
Manual	Keep operation OFF with hard lock

NOTE

For dry contact mode related detail functions, refer to the individual dry contact manual.

What is dry contact?

It means the contact point signal input when the hotel card key, human body detection sensor, etc. are interfacing with the unit.

Added system functionality by using external inputs (dry contacts and wet contacts).

Central Control Address

When connecting the central control, set the central control address of the unit.

- In the installer setting list, select Central Control Address category, and press [OK] button to move to the detail screen.

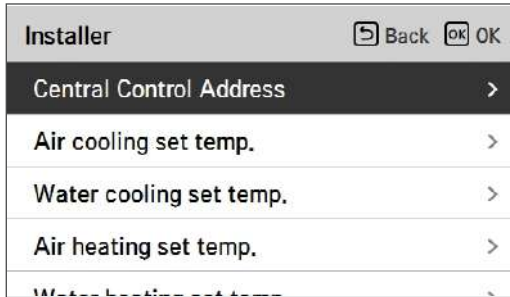

NOTE

Enter address code as hexadecimal value
 Front: Central Control Gr. No.
 Back side: Central control indoor the number

NOTE

This function is not available for monobloc

Pump test run

The pump test run is to test run by operating the water pump for 1 hour.

This function can be used for air purging through air vents and checking flow rate and others.

- In the installer setting list, Pump Test run category, and press [OK] button to move to the detail screen.

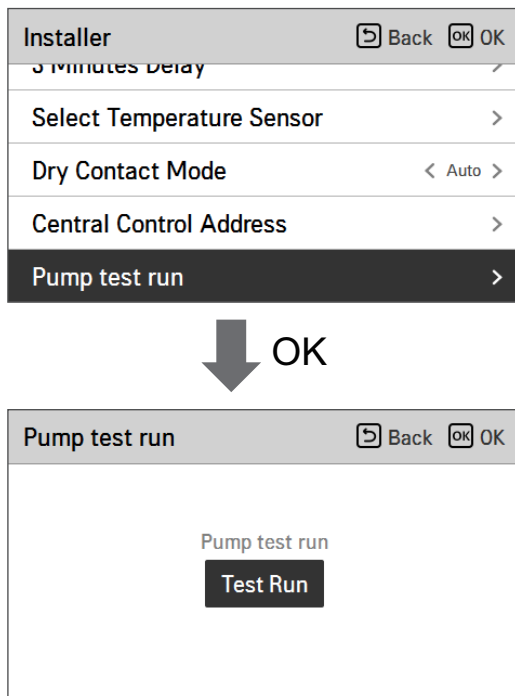

Air cooling set temp.

Determine cooling setting temperature range when air temperature is selected as setting temperature.

- In the installer setting list, select Air cooling set temp category, and press [OK] button to move to the detail screen.

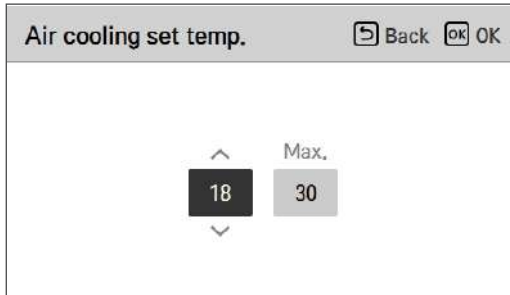
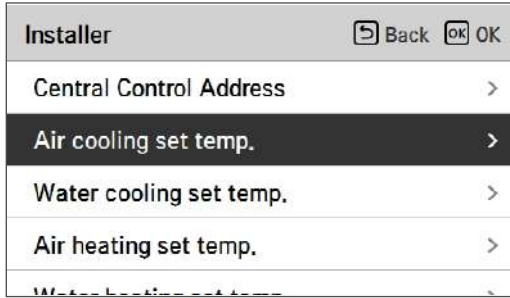

Value	Default	Range
Max.	30	30~24
Min.	18	22~16

* Upper / lower limit / default value is in °C

NOTE

Only available when remote air temperature sensor is connected.

- Accessory PQRSTA0 should be installed.
- Also, Remote air sensor connection should be set properly.

Water cooling set temp.

Determine cooling setting temperature range when leaving water temperature is selected as setting temperature.

- In the installer setting list, select water cooling set temp category, and press [OK] button to move to the detail screen.

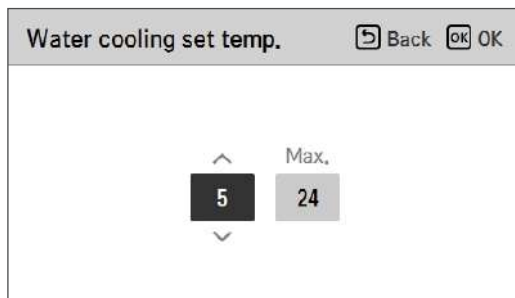
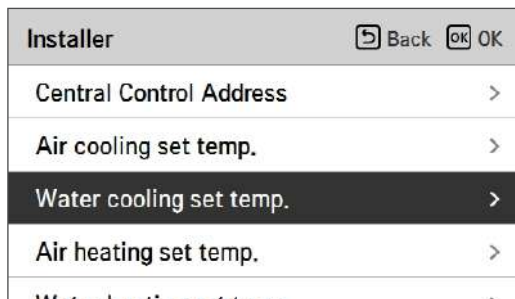

Value	Default	Range
Max.	24	27~22
Min.	18	20~5

* Upper / lower limit / default value is in °C

NOTE

Water condensation on the floor

- While cooling operation, it is very important to keep leaving water temperature higher than 16 °C. Otherwise, dew condensation can be occurred on the floor.
- If floor is in humid environment, do not set leaving water temperature below 18 °C.

NOTE

Water condensation on the radiator

- While cooling operation, cold water may not flow to the radiator. If cold water enters to the radiator, dew generation on the surface of the radiator can be occurred.

Air heating set temp.

Determine heating setting temperature range when air temperature is selected as setting temperature

- In the installer setting list, select Air heating set temp. category, and press [OK] button to move to the detail screen.

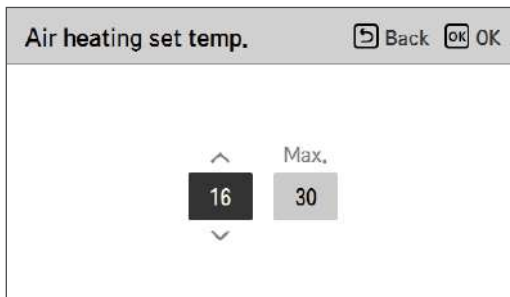
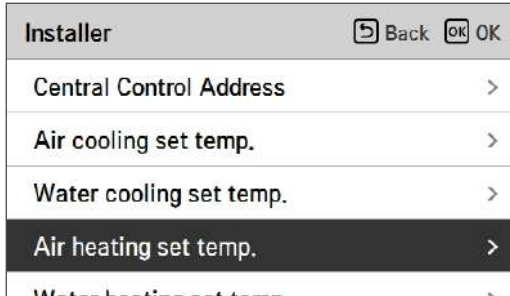

Value	Default	Range
Max.	30	30~24
Min.	16	22~16

* Upper / lower limit / default value is in °C

⚠ CAUTION

Only available when remote air temperature sensor is connected.

- Accessory PQRSTA0 should be installed.
- Also, Remote air sensor connection should be set properly.

Water heating set temp.

Determine heating setting temperature range when water temperature is selected as setting temperature.

- In the installer setting list, select Water heating set temp. category, and press [OK] button to move to the detail screen.

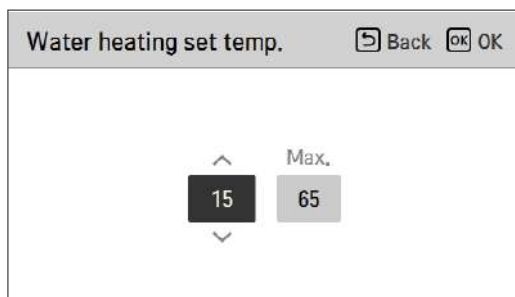
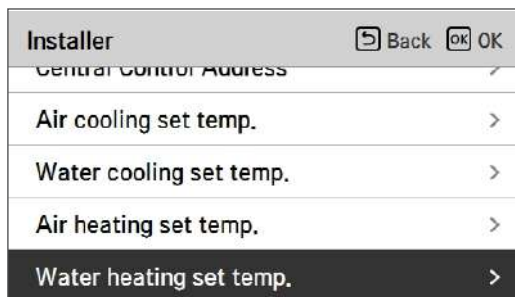

Value	Default		Range	
	For R410A	For R32	For R410A	For R32
Max.	57	65	57~35	65~35
Min.	15		34~15	

* Upper / lower limit / default value is in °C.

NOTE

- When the backup heater is not used, the minimum temperature of the water temperature can be set from 34 °C to 20 °C. (Default : 20 °C)

DHW set temp.

Determine heating setting temperature range when DHW temperature is selected as setting temperature

- In the installer setting list, select DHW set temp. category, and press [OK] button to move to the detail screen.

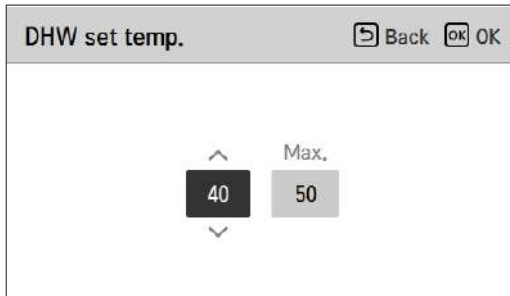
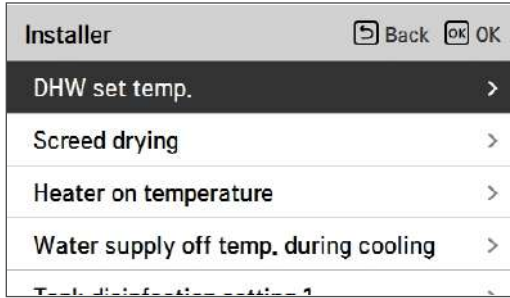

Value	Range (°C)	Default (°C)
Max.	80~50	50
Min.	40~30	40

Screed drying

This function is a unique feature of AWHP that, when AWHP is installed in a new concrete structure, controls the specific temperature floor heating out temperature for a certain period of time to cure the floor cement.

- In the installer setting list, select Screed drying category, and press [OK] button to move to the detail screen.

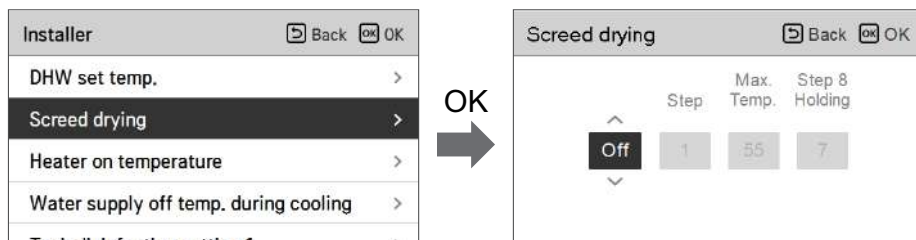

How to display

Main Screen - Displays 'Screed drying' on the desired temperature display. The step in progress at the bottom of the display is displayed.

Setting value

- Start-up step: 1 ~ 11
- Maximum temperature : 35 °C ~ 55 °C (Default : 55 °C)
- Step 8 Holding time : 1 days ~ 30 days (Default : 7 days)

Function operation

- It is performed by the following procedure from the selected starting step.
- After all steps are completed, turn off the cement curing operation.

Step	1	2	3	4	5	6	7	8	9	10	11
Leaving Water target temperature[°C]	25	Max.T	Off	25	35	45	Max.T	Max.T	45	35	25
Duration [hours]	72	96	72	24	24	24	24	Holding time	72	72	72

- ※ If the upper limit setting value of the heating LW temperature is 55 °C or lower, it is set to 55 °C forcibly.
If the lower limit setting value of the heating LW temperature is 25 °C or higher, it is set to 25 °C forcibly.

NOTE

- During Screed drying operation, button input except for installer function and temperature display is restricted.
- When the power is applied again after a power outage during product operation, the product operation state before power failure is remembered and the product is automatically operated.
- Screed drying operation stops when an error occurs / When error is cleared, restart cement Screed drying. (However, if the wired remote control is reset to the error occurrence state, it is compensated in the unit of one day)
- Upon releasing after an error, Screed drying operation may take up to 1 minute of waiting time after boot up. (The Screed drying operation status is judged as 1 minute cycle.)
- During Screed drying operation, installer function Screed drying operation is selectable.
- During Screed drying operation, starting operation, low noise mode off, low noise time setting off, hot water off, solar heat off.
- During Screed drying operation, simple, sleep, on, off, weekly, holiday, heater does not execute reservation operation.

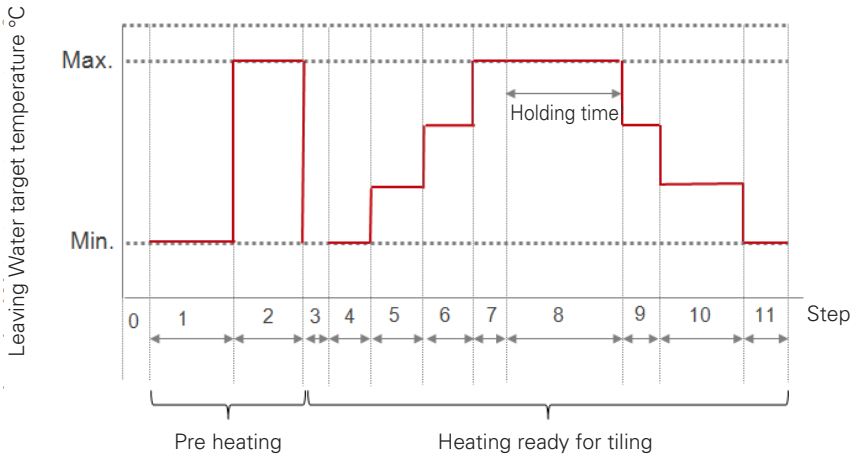

Heater on temperature

Depending on local climatic conditions, it is necessary to change the temperature condition in which backup heater turns on / off.

- In the installer setting list, Heater on temperature category, and press [OK] button to move to the detail screen.

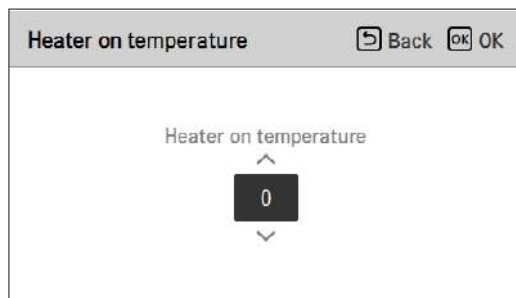
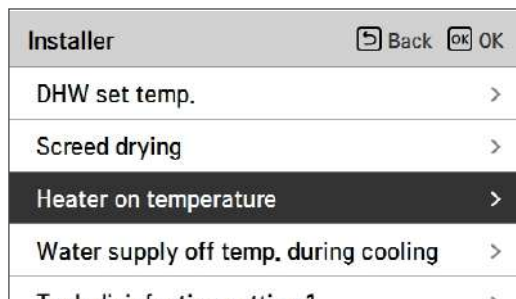

Default (°C)	Range (°C)
-5	18~-15

NOTE**• Heater on temperature**

Using Half capacity of backup heater : when DIP Switch No. 6 and 7 is set as 'ON-OFF' :

- Example : If Heater on temperature is set as '-1' and DIP switch No 6. and 7 is set as 'ON-OFF', then half capacity of backup heater will start operation when outdoor air temperature is below -1 °C and current leaving water temperature or room air temperature is much belower than target leaving water temperature or target room air temperature.

Using Full capacity of backup heater : when DIP Switch No. 6 and 7 is set as 'ON-ON' :

- Example : If Heater on temperature is set as '-1' and DIP switch No 6. and 7 is set as 'ON-ON', then full capacity of backup heater will start operation when outdoor air temperature is below -1 °C and current leaving water temperature or room air temperature is much belower than target leaving water temperature or target room air temperature.

Water supply off temp. during cooling

Determine leaving water temperature when the unit is turned off. This function is used for preventing condensation on the floor in cooling mode

- In the installer setting list, select Water supply off temp. during cooling category, and press [OK] button to move to the detail screen.

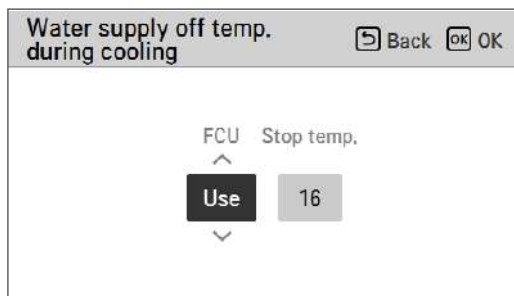
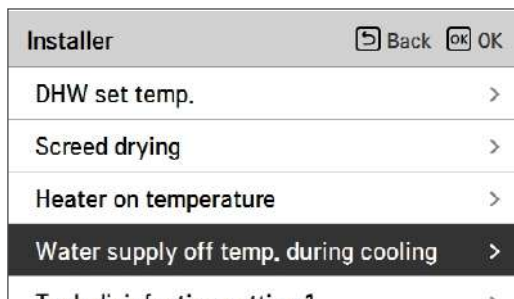

Function	Value	Default	Setting Rang
cooling water temperature	Water supply off temperature	16	25~16
	FCU Use/ not use	use	Use / Not Use

- Stop temp. : cut-off temperature. Stop temp. is valid when FCU is installed.
- FCU : determines if FCU is installed or not.
- Example : If FCU is set as 'Use', Stop temp. setting is disabled. However, if actually FCU is NOT installed in the water loop, the unit operates continuously in cooling mode until water temperature meets desired temperature. In this case, a condensed water may form on the floor caused by cold water in the underfloor coil.
- Example : If Stop temp. is set as '20' and FCU is set as 'Not use' and actually FCU is installed in the water loop, then the Stop temp. is used and the unit stops operation in cooling mode when the leaving water temperature is below 20 °C. As a result, the unit may not offer enough cooling since the cold water with desired temperature doesn't flow into the FCU.



CAUTION

FCU Installation

- If FCU is used, related 2way valve should be installed and connected to the unit PCB.
- If FCU is set as 'Use' whereas FCU or 2way valve is NOT installed, the unit can do abnormal operation.

Tank disinfection setting 1, 2

- Disinfection operation is special DHW tank operation mode to kill and to prevent growth of legionella inside the tank.
 - Disinfection active : Selecting enable or disable of disinfection operation.
 - Start date : Determining the date when the disinfection mode is running.
 - Start time : Determining the time when the disinfection mode is running.
 - Max temp. : Target temperature of disinfection mode.
 - Duration time : Duration of disinfection mode.

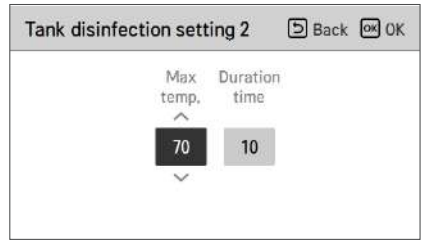
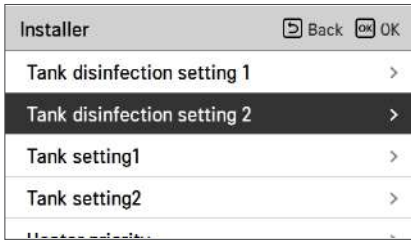
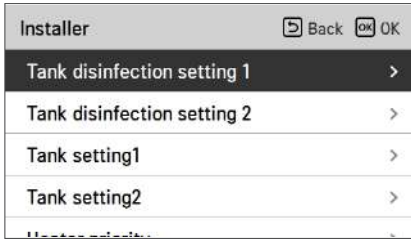
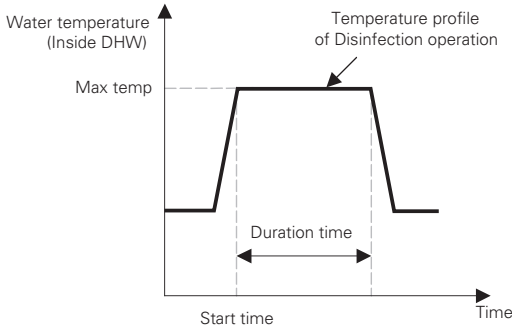

NOTE

DHW heating should be enable

- If Disinfection active is set as ' Not use', that is 'disable disinfection mode', Start date and Start time is not used.

Tank setting 1

- In the installer setting list, select tank setting 1 category, and press [OK] button to move to the detail screen.

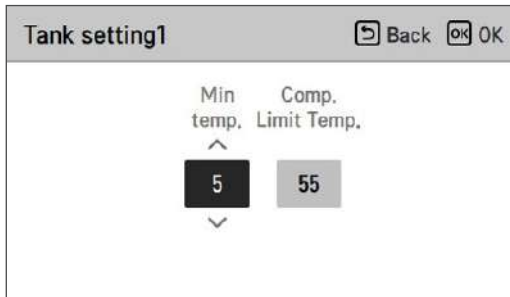
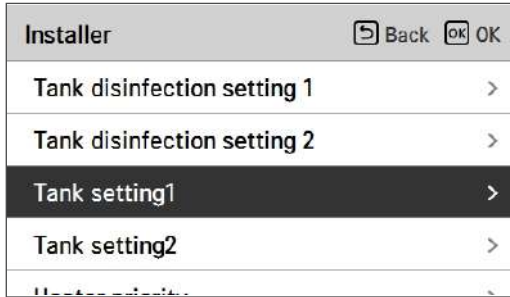

Value	Default (°C)	Range (°C)
Min. temp.	5	30 ~ 1
Comp. Limit Temp.	55	58 ~ 40

Tank setting 2

- In the installer setting list, select tank setting 2 category, and press [OK] button to move to the detail screen.

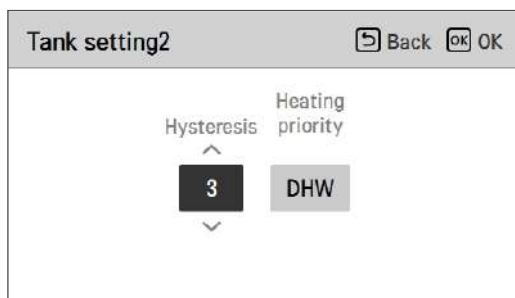
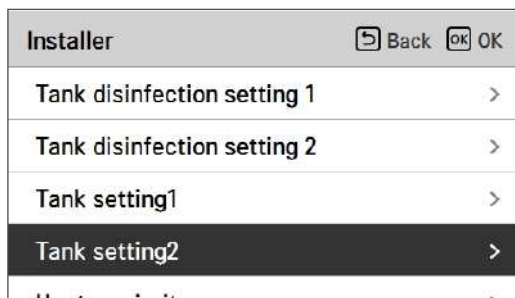

Value	Range
Hysteresis	4~2
Heating priority	Floor heating / DHW

• Tank setting 1, 2

Descriptions for each parameters are as following.

- Min temp. : temperature gap from Max outdoor temp.
- Max outdoor temp. : maximum temperature generated by AWP compressor cycle.
- Example : If Min temp. is set as '5' and Max outdoor temp. is set as '48', then Session A (see the graph) will be started when the water tank temperature is below 43 °C.... If temperature is above 48 °C..., then Session B will be started.
- Hysteresis : temperature gap from target DHW temperature. This value is required to prevent frequent On and Off of booster heater.
- Heating priority : Determining heating demand priority between DHW tank heating and under floor heating.
- Example : If user's target temperature is set as '70' and Hysteresis is set as '3', then the booster heater will be turned off when the water temperature is above 73 °C. The booster heater will be turned on when the water temperature is below 70 °C.
- Example : If Heating priority is set as 'DHW', that means heating priority is on DHW heating, DHW is heated by AWP compressor cycle and booster heater. In this case the under floor can not be heated while DHW heating. On the other hand, if the Heating priority is set as 'Floor heating', that means heating priority is on under floor heating, DHW tank is ONLY heated by booster heater. In this case the under floor heating is not stopped while DHW is heated.

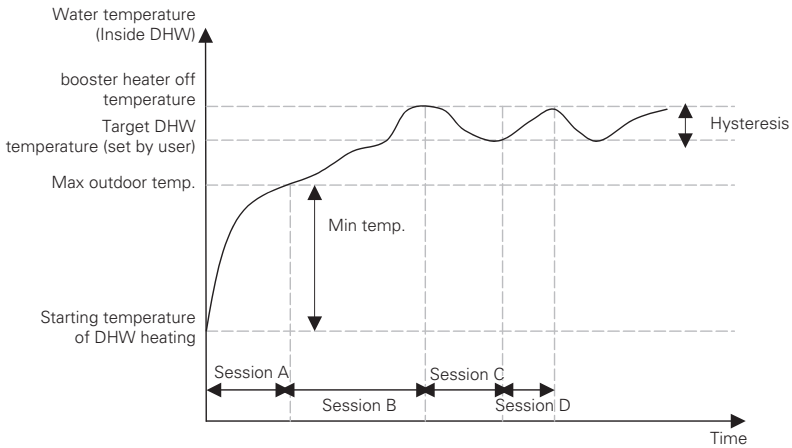

- Session A : Heating by AWP compressor cycle and booster heater
- Session B : Heating by booster heater
- Session C : No heating (booster heater is Off)
- Session D : Heating by booster heater

NOTE

DHW heating does not operate when it is disabled.

Heater priority

- Heater priority : Determine usage of backup heater and booster heater.
- Example : If Heater priority is set as 'Main+Boost heater ON', then backup heater and booster heater are on and off according to control logic. If Heater priority is set as 'Boost heater only ON', then backup heater is never turned on and only booster heater is on and off according to control logic.
- In the installer setting list, heater priority category, and press [OK] button to move to the detail screen.

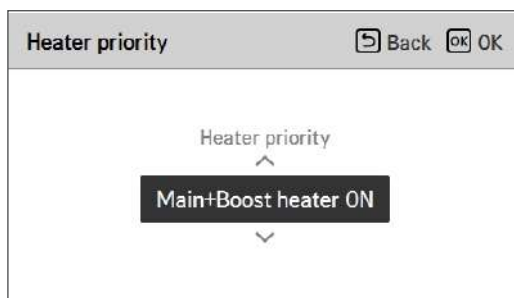
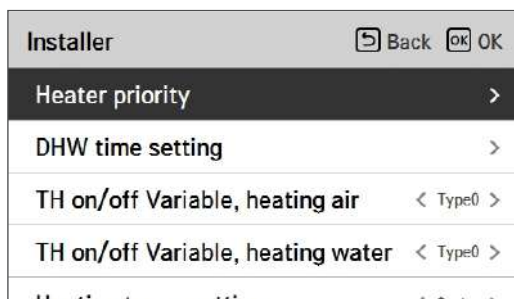

Value	
Boost heater only ON	Main+Boost heater ON (Default)

DHW time setting

Determine following time duration : operation time of DHW tank heating, stop time of DHW tank heating, and delay time of DHW tank heater operating.

- Active time : This time duration defines how long time DHW tank heating can be continued.
- Stop time : This time duration defines how long time DHW tank heating can be stopped. It is also regarded as time gap between DHW tank heating cycle.
- Boost heater delay time : This time duration defines how long time DHW tank heater will not be turned on in DHW heating operation.
- Example of timing chart :

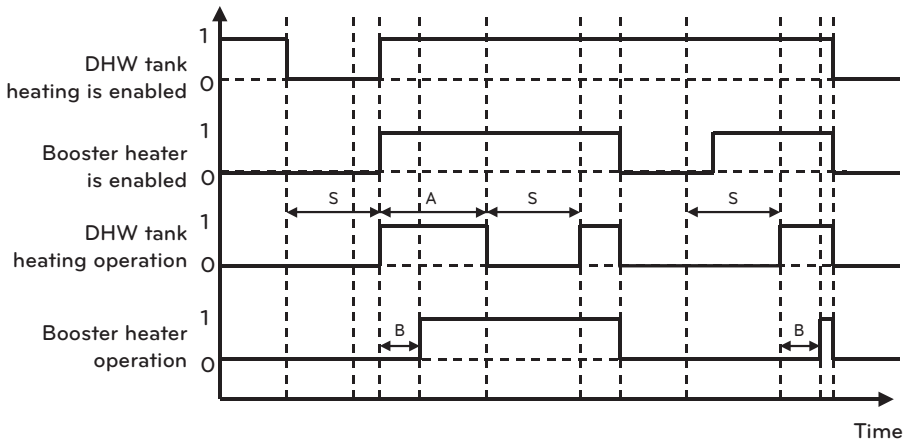

- * 1=active / 0=not active
- * A = Active time
- * S = Stop time
- * B = Boost heater delay time



Value	Default	Range
Active time	30 min	5~95 min
Stop time	30 min	0~600 min

TH on/off Variable, heating air

It is a function to adjust the heating air temperature Thermal On / Off temperature according to the field environment in order to offer optimized heating operation.

- You can set the following setting values using [<,>(left/right)] button.

Installer	⏪ Back	OK
Heater priority		>
DHW time setting		>
TH on/off Variable, heating air	< Type0	>
TH on/off Variable, heating water	< Type0	>
Heating time setting		>

Value	Description	
	TH On	TH Off
Type0 (Default)	-0.5 °C	1.5 °C
Type1	-1 °C	2 °C
Type2	-2 °C	3 °C
Type3	-3 °C	4 °C

TH on/off Variable, heating water

It is a function to adjust the heating water temperature Thermal On / Off temperature according to the field environment in order to offer optimized heating operation.

- You can set the following setting values using [**<**,**>**(left/right)] button.

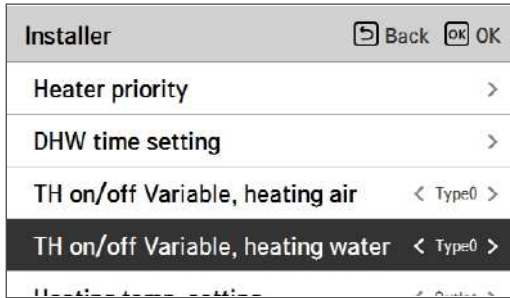

Value	Description	
	TH On	TH Off
Type0 (Default)	-2 °C	2 °C
Type1	-3 °C	3 °C
Type2	-4 °C	4 °C
Type3	-1 °C	1 °C

TH on/off Variable, cooling air

It is a function to adjust the cooling air temperature Thermal On / Off temperature according to the field environment in order to offer optimized cooling operation.

- You can set the following setting values using [**<**,**>**(left/right)] button.

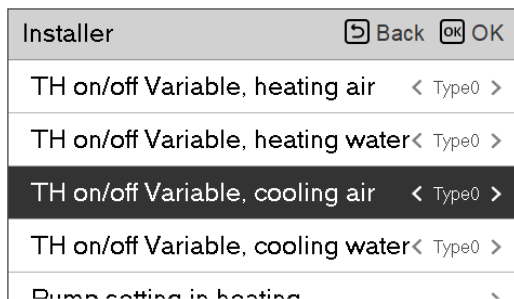

Value	Description	
	TH On	TH Off
Type0 (Default)	0.5 °C	-0.5 °C
Type1	1 °C	-1 °C
Type2	2 °C	-2 °C
Type3	3 °C	-3 °C

TH on/off Variable, cooling water

It is a function to adjust the cooling water temperature Thermal On / Off temperature according to the field environment in order to offer optimized cooling operation.

- You can set the following setting values using [<,>(left/right)] button.

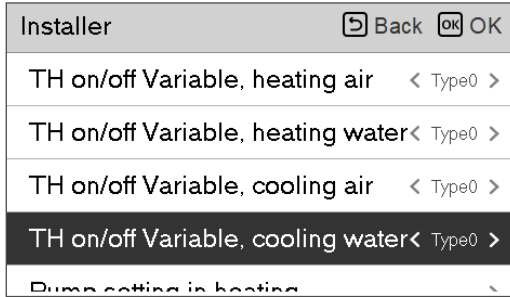

Value	Description	
	TH On	TH Off
Type0 (Default)	0.5 °C	-0.5 °C
Type1	1 °C	-1 °C
Type2	2 °C	-2 °C
Type3	3 °C	-3 °C

Heating temp. setting

- At the water control in heating mode, the control reference water temperature position setting
- If the air / leaving water temperature selection setting is set to leaving water temperature
- Change setting values using [**<**,**>**(left/right)] button
- The function is not available for some products.

Installer		Back	OK
heater priority			
DHW time setting			>
TH on/off Variable, heating air	< Type0 >		
TH on/off Variable, heating water	< Type0 >		
Heating temp. setting	< Outlet >		

Value	
Outlet (Default)	Inlet

Cooling temp. setting

- At the water control in cooling mode, the control reference water temperature position setting
- If the air / leaving water temperature selection setting is set to leaving water temperature
- Change setting values using [**<**,**>**(left/right)] button.
- The function is not available for some products.

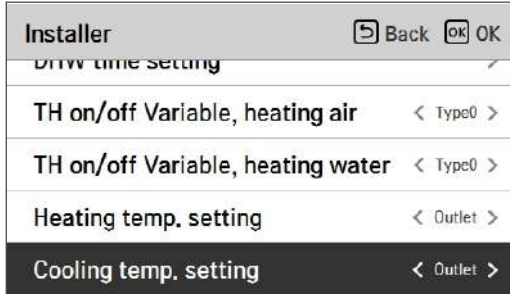

Value	
Outlet (Default)	Inlet

Pump setting in heating

- It is a function to help the water pump's mechanical life by putting the water pump's rest time
- Installer setting function to set water pump on/off interval option during thermo off condition in heating mode.
- In the installer setting list, select Pump setting in heating category, and press [OK] button to move to the detail screen.

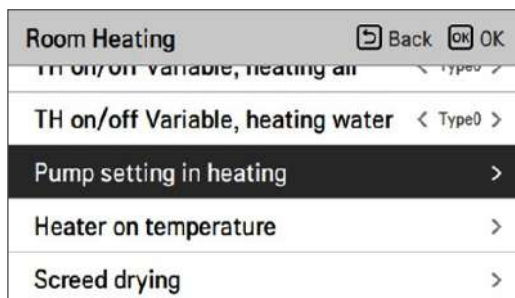

Type	On	Off
Time setting (Default)	1 ~ 60 min (Default : 2 min)	1 ~ 60 min (Default : 1 min)
Operation continue	-	-

Pump setting in cooling

- It is a function to help the water pump's mechanical life by putting the water pump's rest time
- Installer setting function to set water pump on/off interval option during thermo off condition in cooling mode.
- In the installer setting list, select Pump setting in cooling category, and press [OK] button to move to the detail screen.

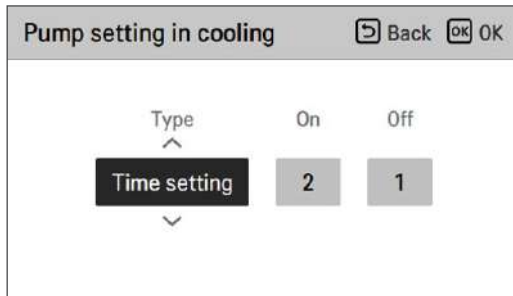
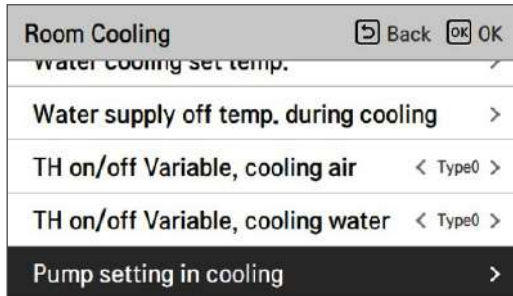

Type	On	Off
Time setting (Default)	1 ~ 60 min (Default : 2 min)	1 ~ 60 min (Default : 1 min)
Operation continue	-	-

LG Therma V Configuration

This function can be set to save the environment settings of the product for use in LG Therma V Configurator through SD Card.

- In the Installer setting list, and select LG Therma V Configuration setting category, and press [OK] button to move to the detail screen.

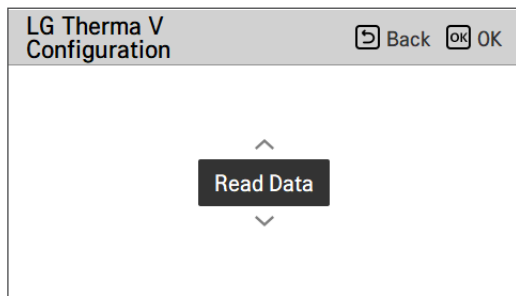
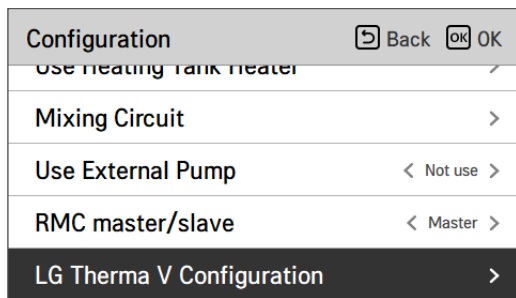

Value	
Read Data	Save Data

Forced operation

- If the product is not used for a long time, the main water pump will be forced to operate for preventing pump failure and PHEX freezing.
- Water pump off After 20 consecutive hours, disable / enable the logic that drives the water pump by itself
- In the installer setting list, select Forced operation category, and press [OK] button to move to the detail screen

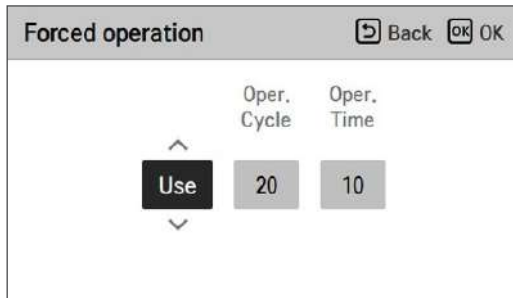
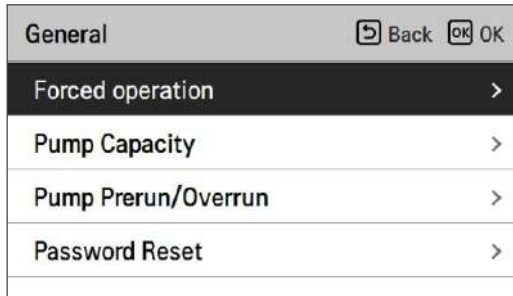

Type	Use (Default)	Not use
Oper. Cycle	20 ~ 180 hours (Default : 20 hours)	-
Oper. Time	1 ~ 10 min (Default : 10 min)	-

CN_CC

It is the function to set the usage of the unit's CN_CC port.

- Change setting values using [<,>(left/right)] button

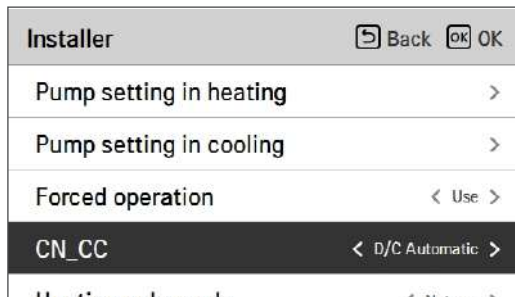

Value	Description
D/C Automatic (Default)	When power is applied to the product, the unit when the contact point is on in Dry Contact installed state recognizes Dry Contact installation
D/C Not Installed	Do not use (install) Dry Contact
D/C Installed	Use (install) Dry Contact

NOTE

CN_CC is the device connected to the unit to recognize and control the external contact point.

Pump frequency setting (RPM)

It is a function to enable installer to control pump RPM of BLDC pump application model.

- In the installer setting list, select Pump frequency setting(RPM) category, and press [OK] button to move to the detail screen.
- The function is not available for some products.

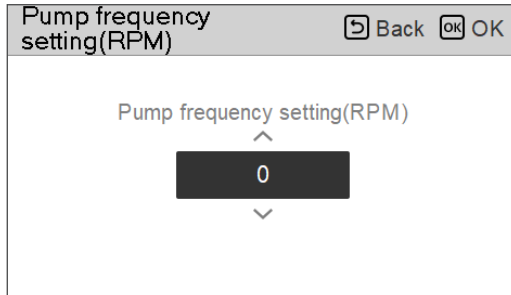
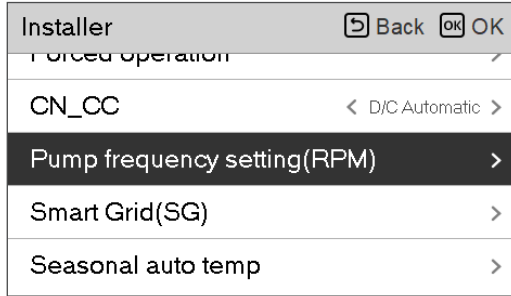

Value	Description
3 500	500~3 700 : RPM Change unit : 10

Pump Capacity

It is a function to enable installer to control Pump capacity application model.

- In the installer setting list, select Pump Capacity category, and press [OK] button to move to the detail screen.
- The function is not available for some products.

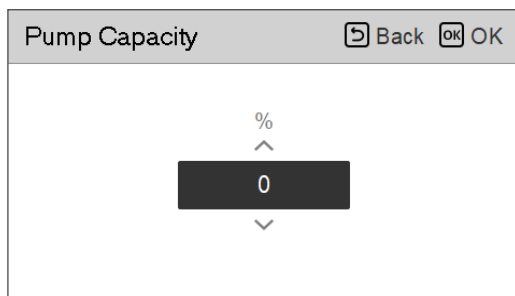
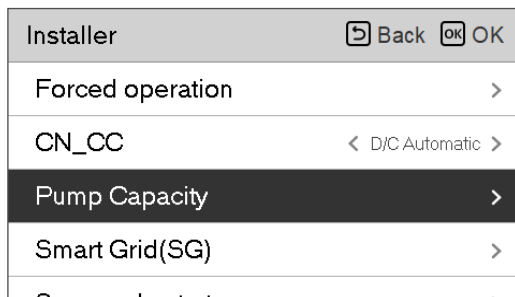

Value	Description
100 (Default)	10~100 : % Change unit: 5

Smart Grid(SG)

It is the function to enable / disable the SG Ready function and to set the reference value at SG2 step.

- In the installer setting list, select Smart Grid(SG) category, and press [OK] button to move to the detail screen.

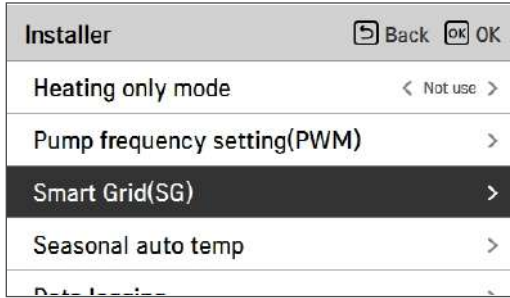

Value	Mode
Not use (Default)	-
Use	Step 0
	Step 1
	Step 2

Power Supply Blockage (Smart Grid)

The heat pump operated automatically by the power supply status signals from power supply companies. This function can respond to European countries' special tariff for heat pump using on a smart grid.

4 modes
depending on
power supply status

Power Supply Status



Operating Mode

0:0 [Normal Operation]

The heat pump works at maximum efficiency.

1:0 [Switch-off command, Utility lock]

Deactivates the heat pump to avoid peak load. The maximum blocking time depends on the system's thermal storage capacity, but amounts to at least 2 hours 3 times a day. (No frost protection)

0:1 [Switch-on recommendation]

The switch-on recommendation and set value storage tank temperature is increased, depending on the parameter "Mode SG"

Mode SG : set temperature + α
depending on the below
parameter

Step 0 (DHW +5 °C)

Step 1 (H/P+2 °C, DHW +5 °C)

Step 2 (H/P+5 °C, DHW +7 °C)

1:1 [Switch-on command]

The command activates the compressor. Optionally, electrical booster heaters can be activated to utilize electricity surpluses.

Seasonal auto temp.

It is the function to set the operation reference value in Seasonal Auto mode.

- In the installer setting list, select Seasonal auto temp category, and press [OK] button to move to the detail screen.

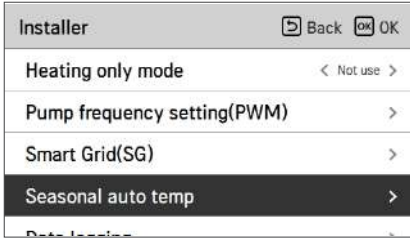

Function	Description	Range		Default	Boundary
		For R32	For R410A		
Outdoor1,Heat (Out1)	Heating lower ambient temp	-25 ~ 35 °C	-15 ~ 24 °C	-10 °C	Out1 ≤ Out2-1
Outdoor2,Heat (Out2)	Heating higher ambient temp			16 °C	Out2 ≥ Out1 +1 Out2 ≤ Out3-5
Outdoor3,Cool (Out3)	Cooling lower ambient temp	10 ~ 46 °C	10 ~ 43 °C	30 °C	Out3 ≥ Out2 +5 Out3 ≤ Out4 -1
Outdoor4,Cool (Out4)	Cooling higher ambient temp			40 °C	Out4 ≥ Out3 +1
Water1,Heat (LW1)	Heating higher water temp	Use heater : LW STD : 15~65 °C EW STD : 15~55 °C Not use heater : LW STD : 20~65 °C EW STD : 20~55 °C	15 ~ 57 °C	35 °C	LW1 ≥ LW2
Water 2,Heat (LW2)	Heating lower water temp			28 °C	LW1 ≥ LW2
Water3,Cool (LW3)	Cooling higher water temp	Use FCU & 5 °C IDU : LW STD : 5~27 °C EW STD : 10~27 °C Use FCU & 6 °C IDU : LW STD : 6~27 °C EW STD : 11~27 °C Not use FCU : LW STD : 16~27 °C EW STD : 20~27 °C	5 ~ 25 °C	20 °C	LW3 ≥ LW4
Water4,Cool (LW4)	Cooling lower water temp			16 °C	LW3 ≥ LW4
Air 1, Heat (RA1)	Heating higher air temp	16 ~ 30 °C	16 ~ 30 °C	30 °C	RA1 ≥ RA2
Air 2, Heat (RA2)	Heating lower air temp			26 °C	RA1 ≥ RA2
Air 3, Cool (RA3)	Cooling higher air temp	18 ~ 30 °C	18 ~ 30 °C	22 °C	RA3 ≥ RA4
Air 4, Cool (RA4)	Cooling lower air temp			18 °C	RA3 ≥ RA4

- Setting range: Celsius
- Seasonal Auto Driving mode: Heating, Heating & Cooling, Air-conditioning
- * If heating mode is selected, heating & cooling or cooling can not be selected.
- Depending on the air / outflow control selection value, the water / air related setting value is displayed on the screen.

In this mode, setting temperature will follow outdoor temperature automatically. This mode adds the cooling season function to the conventional weather dependent operation mode.

	Auto-Adjustable Target Temp.	Room Air Temp.(°C)	Leaving Water Temp.	Outdoor Air Temp.	
Heating	Set point 1	30~20	57~39	Set point 5	-20 ~ -10
	Set point 2	19~16	38~20	Set point 6	-5 ~ 5
Cooling	Set point 3	30~24	25~17	Set point 7	10 ~ 18
	Set point 4	23~18	16~6	Set point 8	22 ~ 30

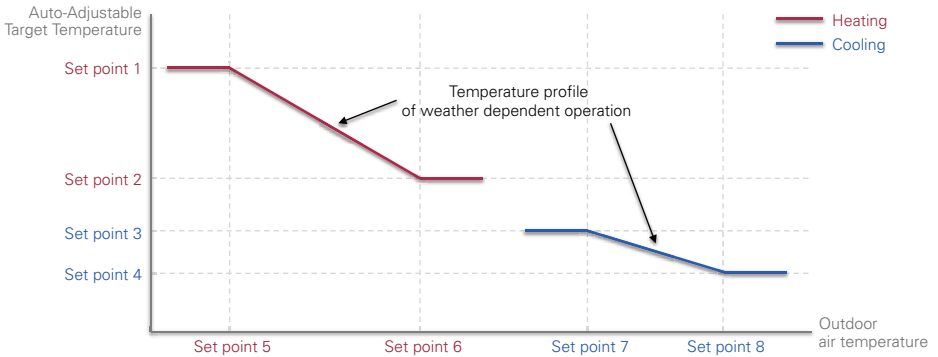

Modbus Address

It is function to set the address of the Modbus device that is externally linked to the product. Modbus address setting function is available from indoor unit.

- In the installer setting list, select Modbus Address , and press [OK] button to move to the detail screen.

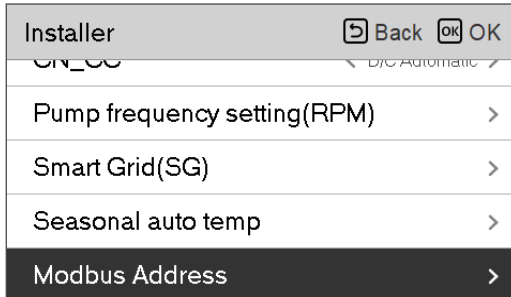

NOTE

To use this function, switch No.1 of option switch 1 must be turned ON.

CN_EXT

It is a function to control external input and output according to DI type set by customer using CN-EXT Port.

- In the installer setting list, select CN-EXT Port category, and press [OK] button to move to the detail screen.

Installer		Back	OK
Pump frequency setting(RPM)	>		
Smart Grid(SG)	>		
Seasonal auto temp	>		
CN_EXT	>		
Add Zone	>		



CN_EXT		Back	OK
Not use	Simple Operation		
Simple Dry Contact	Single emergency stop		

Value			
Not use (Default)	Simple Operation	Simple Dry Contact	Single emergency stop

Anti-freezing Temperature

This function is to apply an offset to the freezing temperature of the freeze protection logic when using antifreeze mode.

- Change setting values using [\leftarrow , \rightarrow (left/right)] button.
- The function is not available for some products.

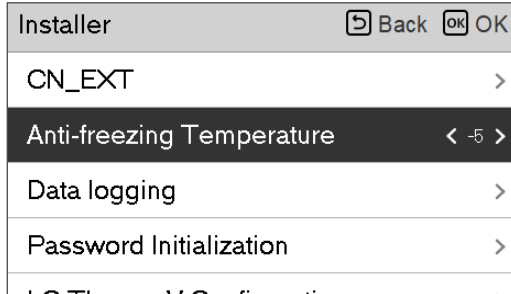

NOTE

To use this function, the antifreeze short pin(CN_FLOW2) must be open and switch No.2 in Option SW 3 must be on.

Add Zone

Function to set whether or not to use a installed 2nd circuit function using mixing kit.

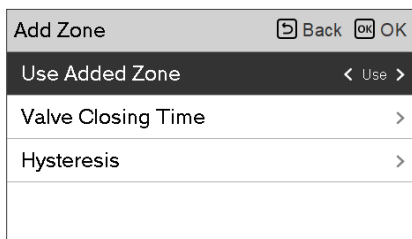
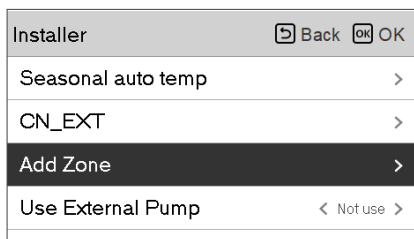

You can set valve closing time[s] and hysteresis temperature[°C] on screen by yourself.

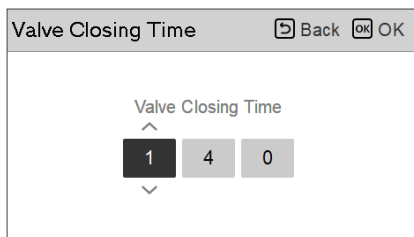

Activating this function, It allows 2 zones(Room1, Room2) temperature to be controlled, separately.

- In case of heating, the temperature of Room1 can not be set higher than Room2 temperature.
- In case of cooling, the temperature of Room1 can not be set lower than Room2 temperature.

Setting range

- Add Zone (2nd Circuit function setting) : Use / Not Use
- Value Closing Time : 60 ~ 999 s (Default: 240)
- Hysteresis (Thermal On / Off) : 1 ~ 5 °C (Default: 2)

Use External Pump

This function can be set to control the external water pump.

- In the installer setting list, select Use External Pump category, and press [OK] button to move to the detail screen.

Installer		Back	OK
Add Zone	>		
Use External Pump	< Not use >		
3rd Party Boiler	>		
Meter Interface	>		
Dump Drain/Overrun	>		

Value	
Not use	Use

3rd Party Boiler

This function is to configure the 3rd party boiler to be controlled.

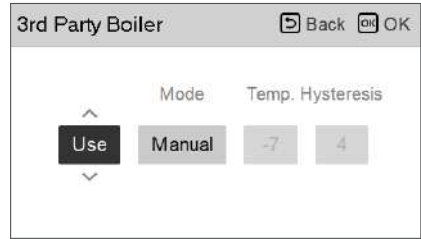

If the status of this function is "Use", you can choose control mode of boiler, Auto or Manual.

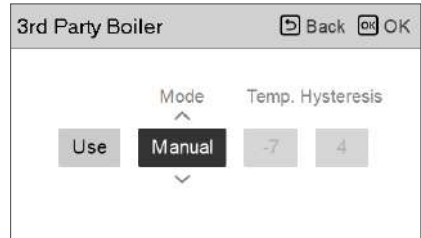
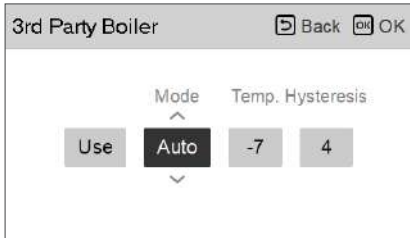

If the mode of this function is set to "Auto", you can set temperature of the boiler and hysteresis, respectively.

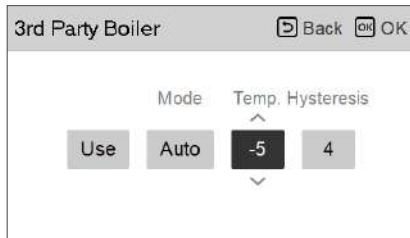

External boiler ON condition :

- If outdoor temperature \leq external boiler operation temperature value (installer setting), turn off the indoor unit and operate the external boiler.

External boiler OFF condition :

- If External air temperature \geq external boiler operation temperature value (installer setting) + Hysteresis (installer setting), turn off external boiler operation and operate indoor unit

Meter Interface

It is the function that can check the status of energy and power on screen. It collects and calculates power or calorie data to create data for energy monitoring and energy warning alarm pop-ups. This function can be activated in installer mode.

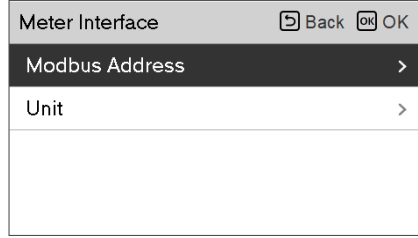
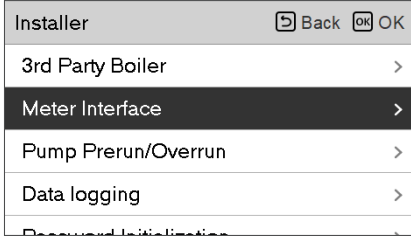

There are 2 options, modbus address and unit, in this function. Activating the modbus address option, you choose one address(B0 or B1) or don't use. Then, you set the port and specification in range of 0000.0~9999.9[pulse/kWh] as shown in the figure below.

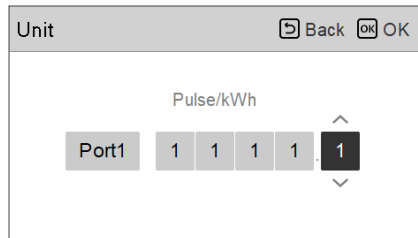
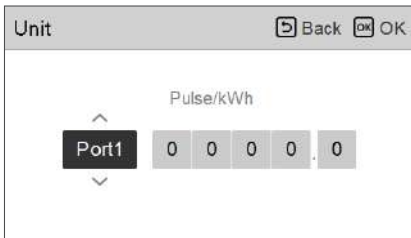

Pump Prerun/Overrun

Pump Prerun operates to ensure sufficient flow before the compressor is operated. This is a function that allows heat exchange to work smoothly.

Pump Overrun is a function to prevent water pump failure and to help mechanical life.

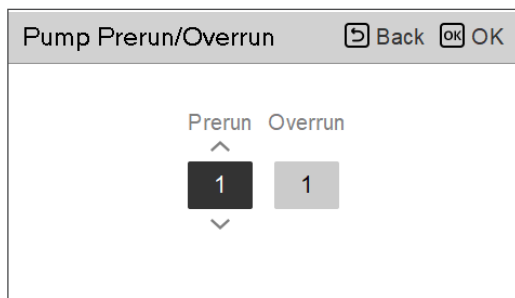
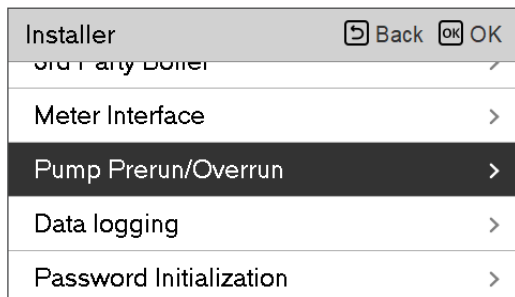

Value	Default	Setting Range
Prerun	1 min	1~10 min
Overrun	1 min	1~10 min

Solar Thermal System

It is function to set operation reference value in Solar Thermal System.

In the installer setting list, select Solar thermal system category, and press [OK] button to move to the detail screen.

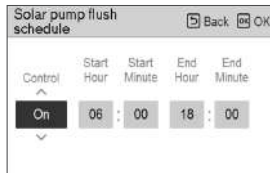
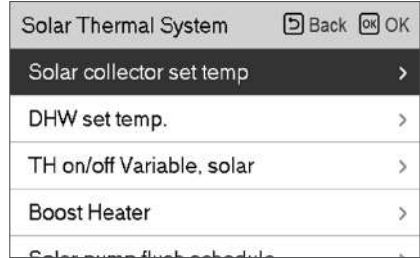
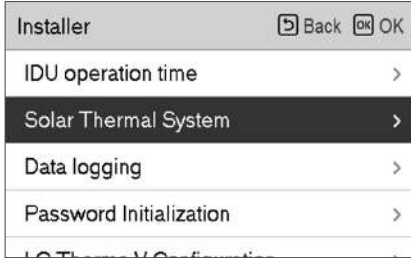

NOTE

To use this function, switch No.2 of option switch 2 must be turned ON and No.3 of option switch 2 must be turned OFF.

Descriptions for each parameters are as following.

- Solar collector set temp
 - Min temp : It is the minimum solar collector temperature at which the solar thermal system can operate.
 - Max temp : It is the maximum solar collector temperature at which the solar thermal system can operate.
- TH on/off Variable, solar
 - Temp on : It is the temperature difference between the current solar thermal temperature and DHW tank temperature at which the solar thermal system operates.
 - Temp off : It is the temperature difference between the current solar thermal temperature and DHW tank temperature at which the solar thermal system stops.
 - Example : If the current solar collector temperature is 80 °C and Temp on is set to 8 °C, the solar thermal system operates when the DHW tank temperature is less than 72 °C. In the same case, if Temp off is set to 2 °C, Solar Thermal System stops when DHW temperature is 78 °C.
- DHW Set Temp
 - Max : It is maximum temperature of DHW that can be reached by solar thermal system.
- Boost Heater
 - Enable : Booster heater can be used when operating the Solar Thermal system.
 - Disable : Booster heater cannot be used when operating the Solar Thermal system.
- Solar pump flush schedule
 - It is the function to circulate the solar water pump intermittently for solar collector temperature detection when the solar water pump does not operate for a long time. Turn on to use this function.
- Solar Pump flush setting
 - Oper.Cycle : When using the solar pump flush function, the solar water pump operates at the set time.
 - Oper.Time : When using the solar pump flush function, the solar water pump operates during the set time.

Function	Value	Range	Default
Solar collector set temp	Min	5 °C ~ 50 °C	10 °C
	Max	60 °C~105 °C	95 °C
DHW set temp	Max	20 °C~90 °C	80 °C
TH on/off Variable, solar	Temp On	3 °C ~ 40 °C	8 °C
	Temp Off	1 °C ~ 20 °C	2 °C
Boost Heater	Boost Heater	Enable/Disable	Enable
Solar pump flush schedule	On/OFF	On/Off	On
	Start Hour, Start Minute	00:00 ~ 24:00	6:00
	End Hour, End Minute	00:00 ~ 24:00	18:00
Solar pump test run	Pump test Run	Start/Stop	Stop
Solar pump flush setting	Oper.Cycle	30 min ~ 120 min	60 min
	Oper.Time	1 min ~ 10 min	1 min

Current flow rate

It is the function to check the current flow rate.

- In the installer setting list, select Current Flow Rate category, and press [OK] button to move to the detail screen. The current flow rate can be checked. (Range : 7 ~ 80 L/min)
- This function is available for Split R32.

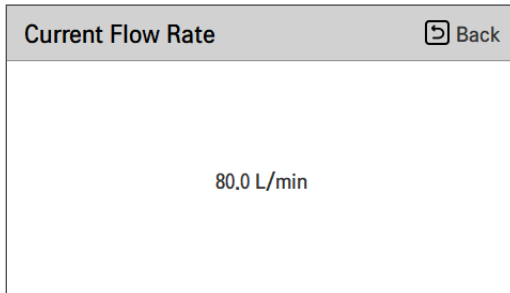
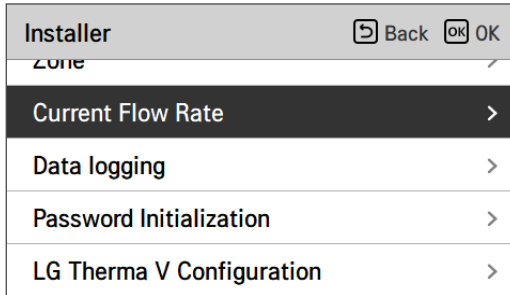

Data logging

This function is to check the operation and error history.

- In the installer setting list, select Data logging category, and press [OK] button to move to the detail screen.

Installer		Back	OK
Heating only mode			
Pump frequency setting(PWM)			>
Smart Grid(SG)			>
Seasonal auto temp			>
Data logging			>



Data logging		Back		
Date	Time	Oper.	Settemp	In/Out
1970.01.01	00:10	Off	-	24° / 25°
1970.01.01	00:09	Off	-	24° / 25°
1970.01.01	00:09	Off	-	24° / 25°
1970.01.01	00:09	Off	-	24° / 25°
1970.01.01	00:09	Off	-	24° / 25°

NOTE

Error history lookup range: 50

Error history information

Item: date, time, mode (including Off), set temperature, incoming temperature, outgoing temperature, room temperature, Hot water operation / stop, Hot water set temperature, Hot water temperature, Outdoor unit On / Off, Error code

Number of Display: Within 50

- Save criteria ▾

▸ Error occurred, released ON / OFF of outdoor unit operation.

Password Initialization

It is the function to initialize (0000) when you forgot the password set in the remote controller.

- In the installer setting list, select the password initialization setting category, and press [OK] button to move to the detail screen.
- When you press "initialization" button, a popup screen appears, and when you press "check" button, password initialization starts, and the user password is changed to 0000.

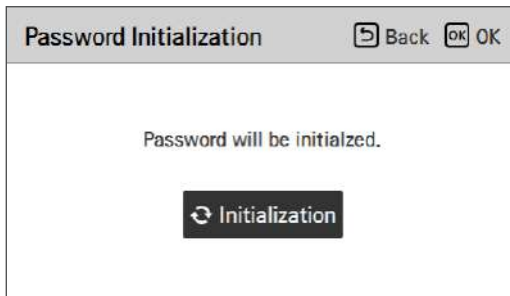
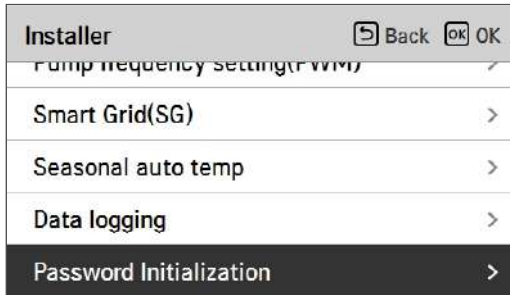

Installer setting (For Split Indoor unit 5 Series, For Hydrosplit)

- You can set the product user functions.
- Some functions may not be displayed/operated in some product types.

Segmentation	Functions	Description
Configuration	Select Temperature Sensor	Selection for setting temperature as air temperature or leaving water temperature or air + leaving water temperature
	Use Heating Tank Heater	Set up to control booster heater
	Mixing Circuit	This function is to use mixing circuit function. Set enable/disable mixing circuit function and valve closing time and hysteresis.
	Use External Pump	Set up to control an external water pump
	RMC master/slave	Function to use 2 remote control environment
	LG Therma V Configuration	Function to save the environment settings of the product for use in LG Therma V Configurator through SD Card.
General settings	Forced operation	Water pump off After 20 consecutive hours, disable / enable the logic that drives the water pump by itself
	Pump Prerun/Overrun	Set to reach the optimum flow rate by circulating the heating water with the water pump before heat exchange. After the operation stop, additional water pump is activated to circulate the heating water.
	Water Flow Control	Set water pump to control the water flow
	Energy Monitoring	Set up to use energy monitoring function of unit
	Password Reset	It is the function to initialize (0000) the password when you forgot the password set in the remote controller.
Room Heating	Heating temp. setting	At the water control in heating mode, the control reference water temperature position setting
	Air heating set temp.	Adjusting range of 'Setting Air Temperature' in heating mode
	Water heating set temp.	Adjusting range of 'Setting Heating Flow Temperature' in heating mode
	Hysteresis Heating Water	Heating Water Outlet Temperature Hysteresis range setting
	Hysteresis Room Air (Heating)	Heating air temperature Hysteresis range setting
	Pump setting in heating	Set water pump on/off interval option during thermo off condition in heating mode
	Heater on temperature	Setting outdoor air temperature where half capacity of backup heater starts operation.
	Screed drying	This function controls floor heating to a specific temperature for a certain period of time to cure floor cement

Segmentation	Functions	Description
Room Cooling	Cooling temp. setting	At the water control in cooling mode, the control reference water temperature position setting
	Air cooling set temp.	Adjusting range of 'Setting Air Temperature' in cooling mode
	Water cooling set temp.	Adjusting range of 'Setting Leaving Water Temperature' in cooling mode
	Water supply off temp. during cooling	Determine the leaving water temperature which blocks the flow into underfloor coil in cooling mode. This function is used for preventing condensation on the floor in cooling mode
	Hysteresis Cooling Water	Cooling Water Outlet Temperature Hysteresis range setting
	Hysteresis Room Air (Cooling)	Cooling air temperature Hysteresis range setting
	Pump setting in cooling	Set water pump on/off interval option during thermo off condition in cooling mode
Auto mode	Seasonal auto temp	Set the operating temperature in Seasonal Auto mode
Domestic hot water	DHW set temp.	Setting DHW set temperature
	Tank disinfection setting 1	Setting start/maintain time for disinfection
	Tank disinfection setting 2	Setting disinfection temperature
	Tank setting 1	Setting minimum and maximum temperature using heat pump cycle for DHW heating
	Tank setting 2	Setting temperature hysteresis and heating priority (DHW heating or floor heating)
	Heater priority	Determine usage of backup heater and booster heater
	DHW time setting	Determine follow time duration : operation time of domestic hot water tank heating, stop time of domestic hot water tank heating, and delay time of DHW tank heater operating
	Recirculation time	Whether to use the recirculation function and set the water pump on/off interval option
Solar thermal	Solar Thermal System	Function to set operation reference value in Solar Thermal System.
Service	Pump test run	Water pump test run
	Frost Protection Temp.	This function is to apply an offset to the freezing temperature of the freeze protection logic when using antifreeze mode

Segmentation	Functions	Description
Connectivity	Dry Contact Mode	Dry contact function is the function that can be used only when the dry contact devices is separately purchased and installed.
	Central Control Address	When connecting the central control, set the central control address of the unit.
	CN_CC	It is the function to set whether to install (use) Dry Contact. (It is not a function for Dry Contact installation, but it is a function to set the usage of the unit's CN_CC port.)
	CN_EXT	Function to set external input and output control according to DI / DO set by customer using dry contact port of indoor unit. Determine the use of the contact port (CN_EXT) mounted on the indoor unit PCB
	3rd Party Boiler	Configuration to control 3rd party boiler
	Meter Interface	When installing the meter interface to measure energy / calorie in the product, set unit spec for each port
	Energy state	Select whether to use or not use the SG Mode function of the product, set the operation option value in SG1 step.
	Thermostat control type	Setting Thermostat control type
	Modbus Address	It is function to set the address of the Modbus device that is externally linked to the product. Modbus address setting function is available from indoor unit.
Info	Pump operation time	Display water pump's operation time
	IDU operation time	Display Indoor Unit's operation time
	Current Flow Rate	Function to check the current flow rate.
	Data logging	Display error and operation history of connected unit

Select Temperature Sensor

The product can be operated according to air temperature or water temperature. The selection for setting temperature as air temperature or water temperature is determined.

- In the installer setting list, Select Temperature Sensor category, and press [OK] button to move to the detail screen.

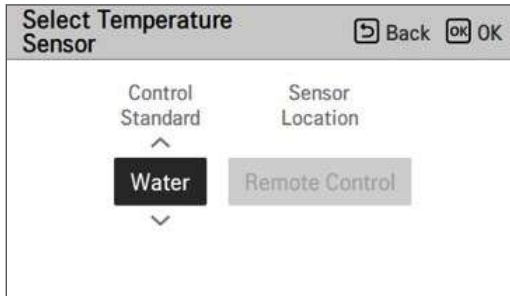
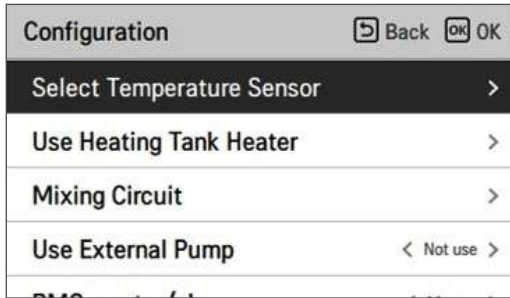

Type	Value	
Water (Default)	Remote Control	
Air	Remote Control	Indoor Unit
Air+Water	Remote Control	Indoor Unit

NOTE

Air temperature as setting temperature is ONLY available when Remote Air Sensor Connection is enabled and Remote Air Sensor Connection is set as 02.

Use Heating Tank Heater

This is a function to change the set value for the operation of the hot water tank heater, such as heating tank heater use /not use and heater delay time.

- In the installer setting list, Select Configuration category, and press [OK] button to move to the detail screen.

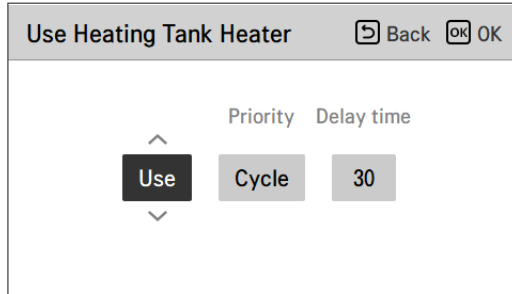
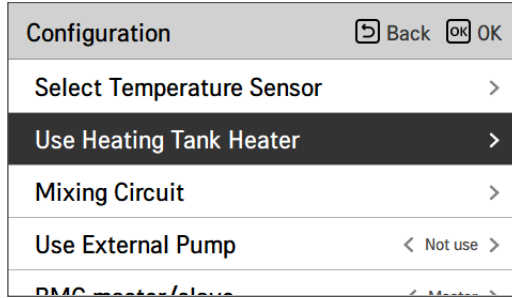

Setting value

- Functions : Use, Not use, Use disinfect (Default : Use)
- Priority : Cycle, Heater/Cycle (Default : Cycle)
- Delay time : 10/20/30/40/50/60/90/120/1440 minute (Default : 30)

Mixing Circuit

Function to set whether or not to use an installed mixing circuit function using mixing kit.

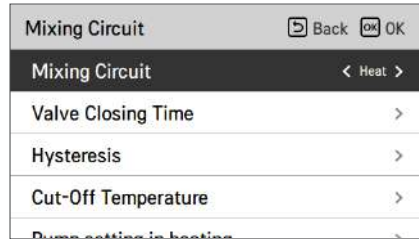
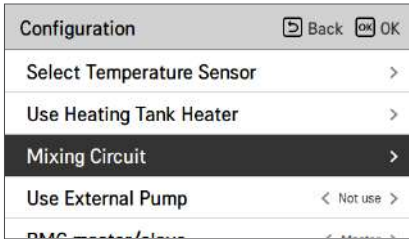

You can set valve closing time[s] and hysteresis temperature[°C] on screen by yourself. Setting the cut-off temperature protects the water from flowing over the cut-off temperature in the mixing circuit during heating operation.



Installer setting function to set water mixing pump operation / delay time option in heating/cooling mode

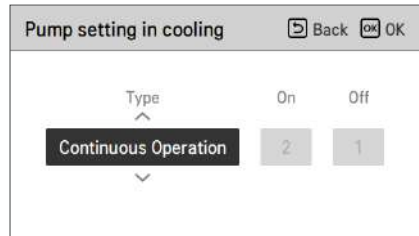
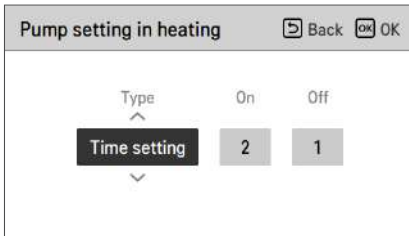

Activating this function, It allows 2 zones(Room1, Room2) temperature to be controlled, separately.

Setting range

- Mixing Circuit (2nd Circuit function setting) : Not Use / Heat / Heat & Cool
- Value Closing Time : 60 ~ 999 s (Default: 240)
- Hysteresis (Thermal On / Off) : 1~3 °C (Default: 2)

NOTE

When using the Mixing Circuit function, the external pump setting must be changed to 'Circuit 1'.

Use External Pump

This function can be set to control the external water pump.

- In the installer setting list, select Use External Pump category, and press [OK] button to move to the detail screen.
- Heating/Cooling
You can use this feature when you have installed a 3 Way valve to switch the water flow between the underfloor and the water tank. The external pump operates only in the direction of water flow in the underfloor.
- Circuit1
This function controls the external pump when operating the mixing circuit. The external pump should be controlled according to Th/on and Th/off in Circuit1(Direct circuit). Therefore, when using the mixing circuit, be sure to set the external pump to 'Circuit1'.

Configuration	Back	OK
Use heating tank heater		✓
Mixing Circuit		>
Use External Pump	< Not use >	
RMC master/slave	< Master >	
LG Therma V Configuration		>

Value			
Not use (Default)	Use	Heat & Cool	Circuit1

RMC master/slave

This function can be select Master/Slave on remote controller to use 2 Remote Control environment

- In the Installer setting list, and select RMC master/slave setting category, and press [<,>(left/right)] button to following setting values.

Configuration	Back	OK
Use heating tank heater		✓
Mixing Circuit		>
Use External Pump	< Not use >	
RMC master/slave	< Master >	
LG Therma V Configuration		>

Value	
Master (Default)	Slave

LG Therma V Configuration

This function can be set to save the environment settings of the product for use in LG Therma V Configurator through SD Card.

- In the Installer setting list, and select LG Therma V Configuration setting category, and press [OK] button to move to the detail screen.

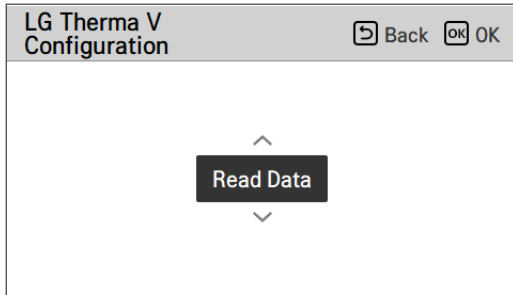
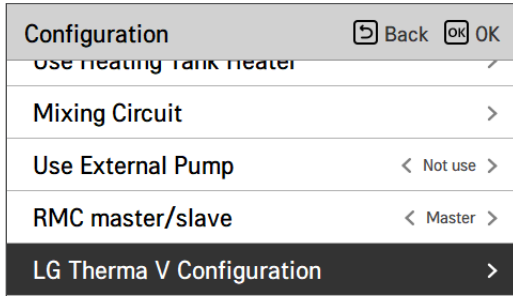

Value	
Read Data (Default)	Save Data

NOTE

When saving the environment setting of the product in the SD card, be sure to save the file name as 'RS3_AWHP_DATA'.

Forced operation

- If the product is not used for a long time, the main water pump will be forced to operate for preventing pump failure and PHEX freezing.
- Water pump off After 20 consecutive hours, disable / enable the logic that drives the water pump by itself
- In the installer setting list, select Forced operation category, and press [OK] button to move to the detail screen

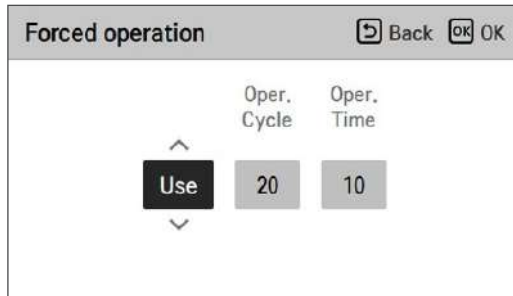
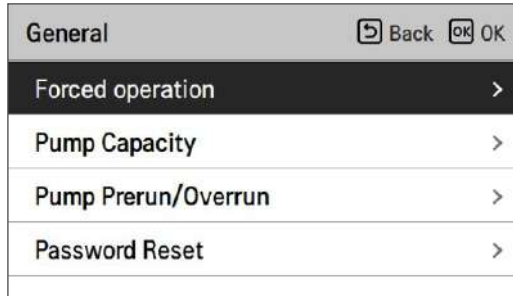

Type	Use (Default)	Not use
Oper. Cycle	20 ~ 180 hours (Default : 20 hours)	-
Oper. Time	1 ~ 10 min (Default : 10 min)	-

Pump Prerun/Overrun

Pump Prerun operates to ensure sufficient flow before the compressor is operated. This is a function that allows heat exchange to work smoothly.

Pump Overrun is a function to prevent water pump failure and to help mechanical life.

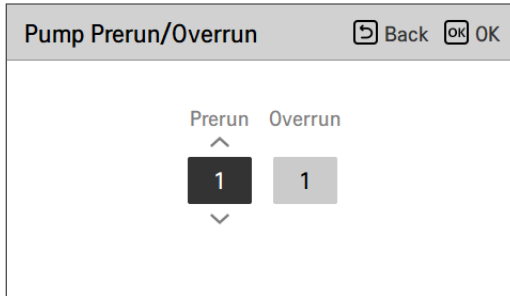
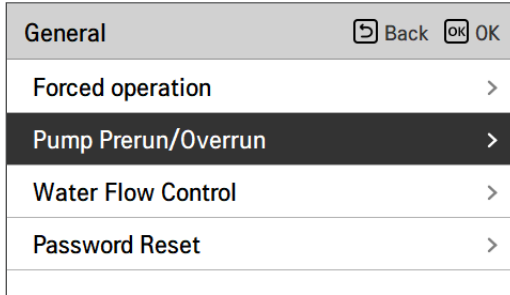

Value	Default	Setting Range
Prerun	1 min	1~10 min
Overrun	1 min	1~10 min

Water Flow Control

This function controls the water flow by controlling the water pump. Select the way to control the water pump and set the target value

- In the installer setting list, select Configuration category, and press [OK] button to move to the detail screen.

- Optimal Flow Rate

The water pump is automatically controlled at the optimum flow rate required according to the desired temperature of the Main screen.

- Pump Capacity

It operates with the capacity set for the water pump.

- Fixed Flow Rate

The water pump is automatically controlled to maintain the set flow rate.

- Fixed ΔT

Set the target ΔT (* ΔT = temperature difference between inlet and outlet water temperature)

The water pump is automatically controlled to maintain the set ΔT .

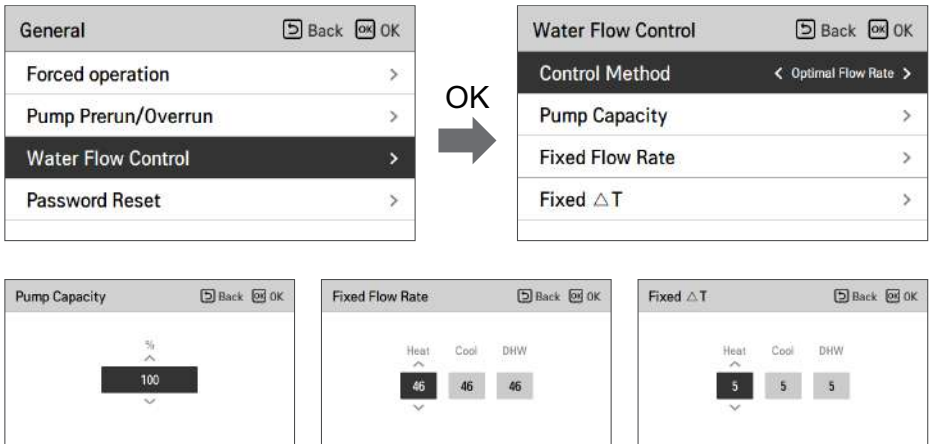

Flow Control Method			
Optimal Flow Rate (Default)	Pump Capacity	Fixed Flow Rate	Fixed ΔT

Energy Monitoring (For Split Indoor unit 5 Series, Hydrosplit 2-Pipe)

This function can be set to use energy monitoring function of unit.

- Change setting values using [**<**,**>**(left/right)] button.

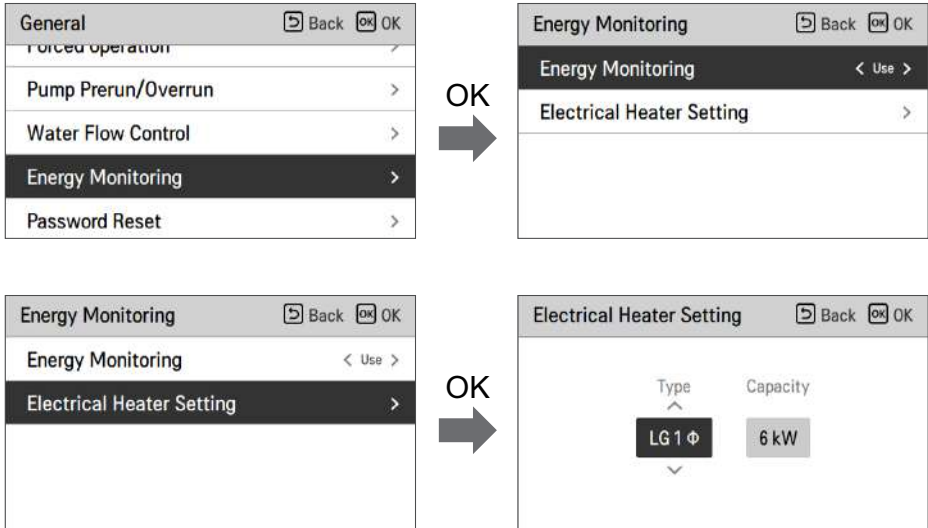

Value		Range	Default
Energy Monitoring		Use/Not Use	Use
Electric Heater Setting	Type	LG 1Ø / LG 3Ø / EXTERNAL	LG 1Ø
	Heater Capacity	1 kW ~ 10 kW	6 kW

Anti-Freezing Option 1 (For Split R32 Indoor unit 5 Series, For Split R410A unit 4 Series, For Hydrosplit 1-Pipe, For Hydrosplit 2-pipe)

This function is to select whether to use Type1 or Type2 to prevent freezing when the remote control is turned off.

- Change setting values using [\leftarrow , \rightarrow] (left/right) button.

General	Back	OK
Pump Filter/Overrun		
Water Flow Control		\rightarrow
Energy Monitoring		\rightarrow
Anti-Freezing Option 1	\leftarrow Type1	\rightarrow
Password Reset		\rightarrow

Value	
Type1(Default)	Type2

CAUTION

If the function is set to Type 2, there is a risk of freezing.

Function	Detection	Case	Operation
Type 1	Type 2 + Inlet Temp.	Air Temp. < Certain Level Inlet Temp. < Certain Level	Pump always ON
		Air Temp. < Certain Level Inlet Temp. > Certain Level	Pump intermittently On
		Air Temp. > Certain Level Inlet Temp. > Certain Level	Pump always OFF
Type 2	Air Temp.	Air Temp. < Certain Level	Pump intermittently On
		Air Temp. > Certain Level	Pump always OFF

Password Reset

It is the function to initialize (0000) when you forgot the password set in the remote controller.

- In the installer setting list, select the password Reset setting category, and press [OK] button to move to the detail screen.
- When you press "Reset" button, a popup screen appears, and when you press "check" button, password initialization starts, and the user password is changed to 0000.

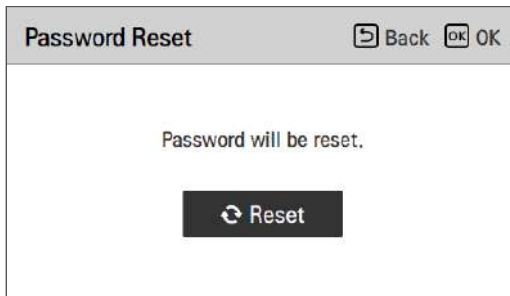
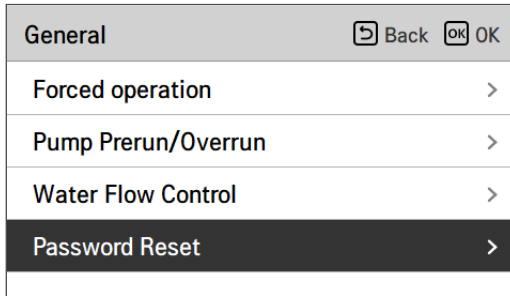

Screed drying

This function is a unique feature of AWHP that, when AWHP is installed in a new concrete structure, controls the specific temperature floor heating out temperature for a certain period of time to cure the floor cement.

- In the installer setting list, select Screed drying category, and press [OK] button to move to the detail screen.

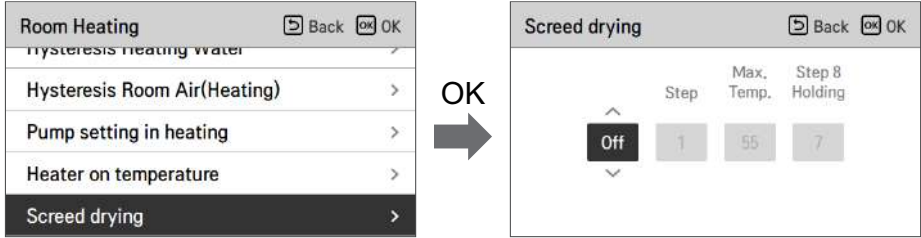

How to display

Main Screen - Displays 'Screed drying' on the desired temperature display. The step in progress at the bottom of the display is displayed.

Setting value

- Start-up step: 1 ~ 11
- Maximum temperature : 35 °C ~ 55 °C (Default : 55 °C)
- Step 8 Holding time : 1 days ~ 30 days (Default : 7 days)

Function operation

- It is performed by the following procedure from the selected starting step.
- After all steps are completed, turn off the cement curing operation.

Step	1	2	3	4	5	6	7	8	9	10	11
Leaving Water target temperature[°C]	25	Max.T	Off	25	35	45	Max.T	Max.T	45	35	25
Duration [hours]	72	96	72	24	24	24	24	Holding time	72	72	72

- ※ If the upper limit setting value of the heating LW temperature is 55 °C or lower, it is set to 55 °C forcibly.

NOTE

- During Screed drying operation, button input except for installer function and temperature display is restricted.
- When the power is applied again after a power outage during product operation, the product operation state before power failure is remembered and the product is automatically operated.
- Screed drying operation stops when an error occurs / When error is cleared, restart cement Screed drying. (However, if the wired remote control is reset to the error occurrence state, it is compensated in the unit of one day)
- Upon releasing after an error, Screed drying operation may take up to 1 minute of waiting time after boot up. (The Screed drying operation status is judged as 1 minute cycle.)
- During Screed drying operation, installer function Screed drying operation is selectable.
- During Screed drying operation, starting operation, low noise mode off, low noise time setting off, hot water off, solar heat off.
- During Screed drying operation, simple, sleep, on, off, weekly, holiday, heater does not execute reservation operation.

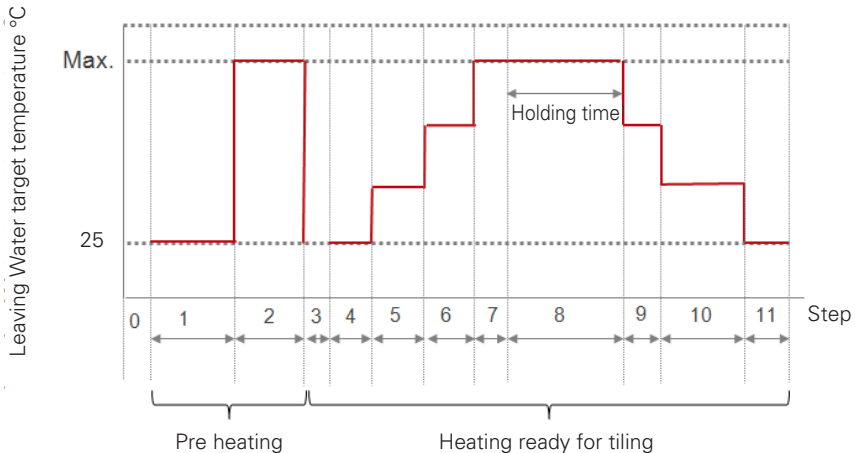

Heater on temperature

Depending on local climatic conditions, it is necessary to change the temperature condition in which backup heater turns on / off.

- In the installer setting list, Heater on temperature category, and press [OK] button to move to the detail screen.

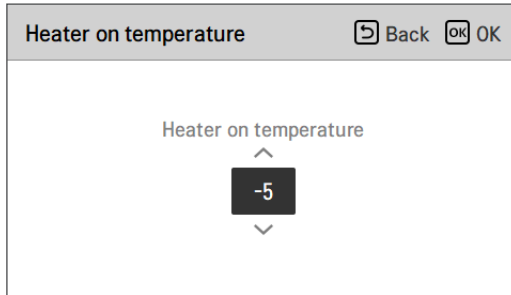
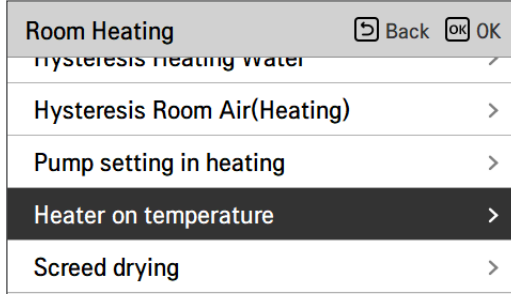

Default (°C)	Range (°C)
-5	18 ~ -25

NOTE**• Heater on temperature**

Using Half capacity of backup heater (For Split Indoor unit 5 Series) : when DIP Switch No. 6 and 7 is set as 'ON-OFF' :

- Example : If Heater on temperature is set as '-1' and DIP switch No 6. and 7 is set as 'ON-OFF', then half capacity of electric heater will start operation when outdoor air temperature is below -1 °C and current leaving water temperature or room air temperature is much below than target leaving water temperature or target room air temperature.

Using Full capacity of backup heater : when DIP Switch No. 6 and 7 is set as 'ON-ON' :

- Example : If Heater on temperature is set as '-1' and DIP switch No 6. and 7 is set as 'ON-ON', then full capacity of electric heater will start operation when outdoor air temperature is below -1 °C and current leaving water temperature or room air temperature is much below than target leaving water temperature or target room air temperature.

Air heating set temp.

Determine heating setting temperature range when air temperature is selected as setting temperature

- In the installer setting list, select Air heating set temp. category, and press [OK] button to move to the detail screen.

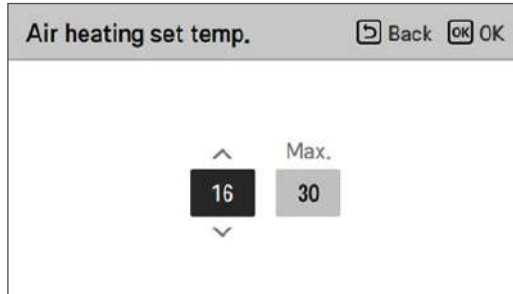
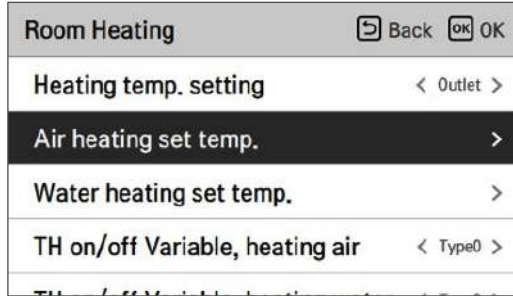

Value	Default (°C)	Range (°C)
Max.	30	30~24
Min.	16	22~16

CAUTION

It is possible to control the unit based on room air temperature by using either remote air temperature sensor or wired remote controller (RS3).

- Remote room air sensor is an accessory (PQRSTA0) and sold separately.
- DIP switch setting should be set properly in order to control the unit based on room air temperature.

Water heating set temp.

Determine heating setting temperature range when water temperature is selected as setting temperature.

- In the installer setting list, select Water heating set temp. category, and press [OK] button to move to the detail screen.

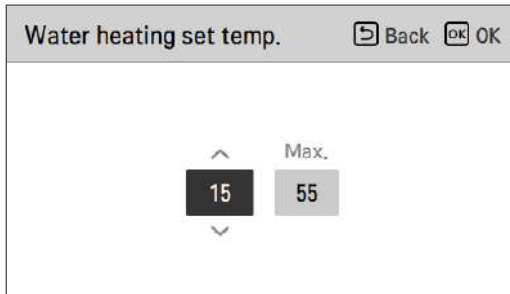
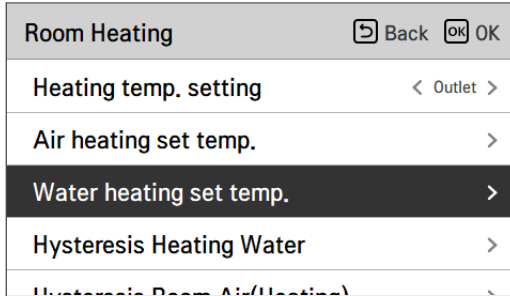

Value	Default (°C)	Range (°C)
Max.	55	65 ~ 35
Min.	15	34 ~ 15

NOTE

- When the backup heater is not used, the minimum temperature of the water temperature can be set from 34 °C to 20 °C. (Default : 20 °C)

Hysteresis Room Air(Heating)

It is a function to adjust the heating air temperature Thermal On / Off temperature according to the field environment in order to offer optimized heating operation.

- In the Installer setting list, and select Hysteresis Room Air(Heating) category, and press [OK] button to move to the detail screen.

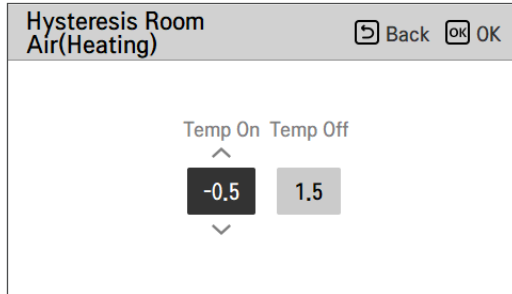
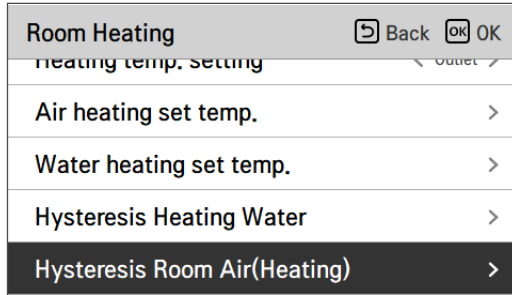

Type	Default (°C)	Range (°C)
Temp On	-0.5	0 ~ -3
Temp Off	1.5	4 ~ 0

Hysteresis Heating Water

It is a function to adjust the heating water temperature Thermal On / Off temperature according to the field environment in order to offer optimized DHW heating operation.

- In the Installer setting list, and select Hysteresis Heating Water category, and press [OK] button to move to the detail screen.

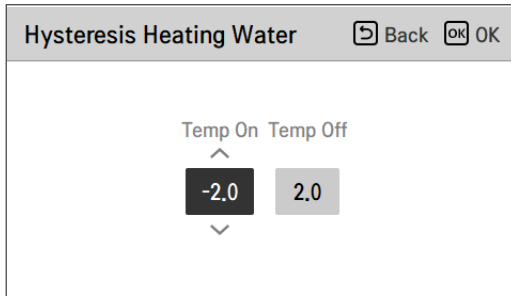
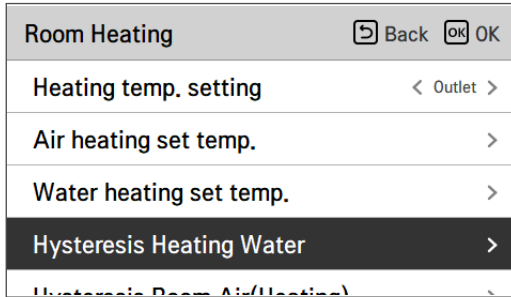

Type	Default (°C)	Range (°C)
Temp On	-2	0 ~ -9
Temp Off	2	4 ~ 0

Heating temp. setting

- At the water control in heating mode, the control reference water temperature position setting
- If the air / leaving water temperature selection setting is set to leaving water temperature
- Change setting values using [**<**,**>**(left/right)] button
- The function is not available for some products.

Room Heating		Back	OK
Heating temp. setting		< Outlet >	
Air heating set temp.	>		
Water heating set temp.	>		
Hysteresis Heating Water	>		
Hysteresis Room Air (Heating)	>		

Value	
Outlet (Default)	Inlet

Pump setting in heating

- It is a function to help the water pump's mechanical life by putting the water pump's rest time
- Installer setting function to set water pump on/off interval option during thermo off condition in heating mode.
- In the installer setting list, select Pump setting in heating category, and press [OK] button to move to the detail screen.

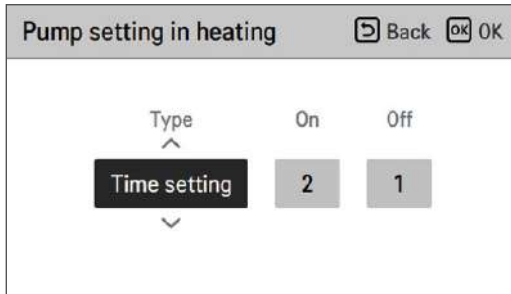
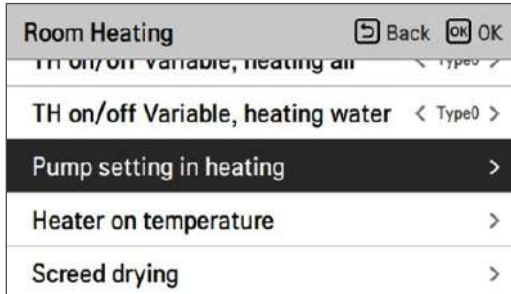

Type	On	Off
Time setting (Default)	1 ~ 60 min (Default : 2 min)	1 ~ 60 min (Default : 1 min)
Operation continue	-	-

Air cooling set temp.

Determine cooling setting temperature range when air temperature is selected as setting temperature.

- In the installer setting list, select Air cooling set temp category, and press [OK] button to move to the detail screen.

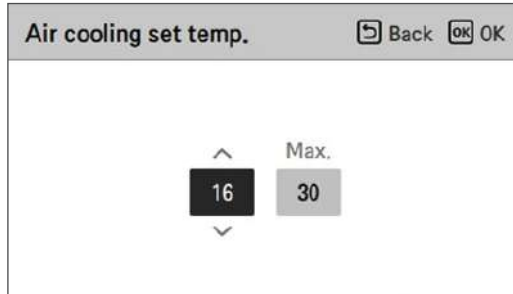
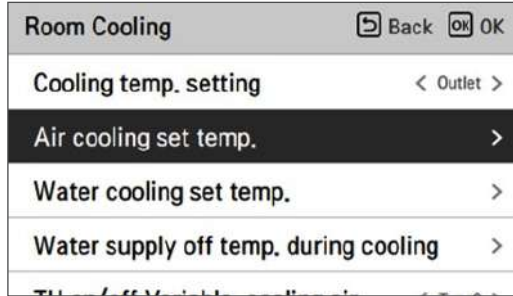

Value	Default (°C)	Range (°C)
Max.	30	30~24
Min.	18	22~16

NOTE

It is possible to control the unit based on room air temperature by using either remote air temperature sensor or wired remote controller (RS3).

- Remote room air sensor is an accessory (PQRSTA0) and sold separately.
- DIP switch setting should be set properly in order to control the unit based on room air temperature.

Water cooling set temp.

Determine cooling setting temperature range when water temperature is selected as setting temperature.

- In the installer setting list, select water cooling set temp category, and press [OK] button to move to the detail screen.

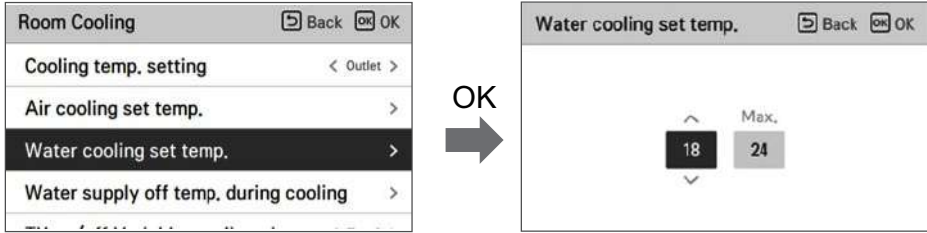

Value	Default (°C)	Range (°C)	Cooling temp. setting	
Max.	24	27~22	All	
Min.	18	5~20	Outlet	FCU use
		16~20		FCU not used
		10~20	Inlet	FCU use
	20	FCU not used		

NOTE

Water condensation on the floor

- While cooling operation, it is very important to keep leaving water temperature higher than 16 °C. Otherwise, dew condensation can be occurred on the floor.
- If floor is in humid environment, do not set leaving water temperature below 18 °C.

NOTE

Water condensation on the radiator

- While cooling operation, cold water may not flow to the radiator. If cold water enters to the radiator, dew generation on the surface of the radiator can be occurred.

Water supply off temp. during cooling

Determine the leaving water temperature which blocks the flow into underfloor coil in cooling mode. This function is used for preventing condensation on the floor in cooling mode

- In the installer setting list, select Water supply off temp. during cooling category, and press [OK] button to move to the detail screen.

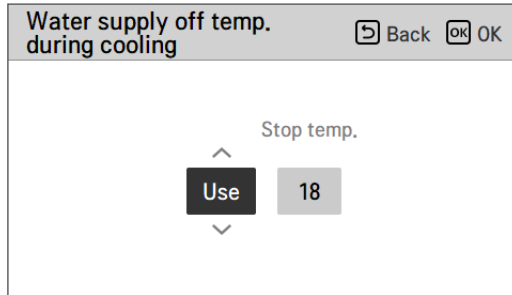
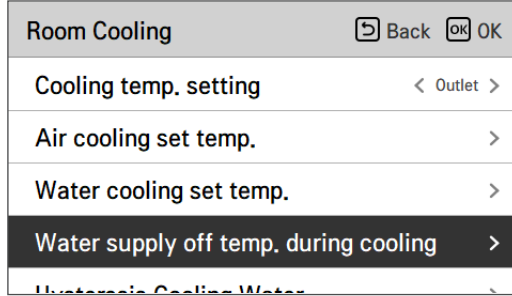

Value	Default	Range
Use	18	25 ~ 16
Not use	-	-

- Stop temp. : cut-off temperature. Stop temp. is valid when FCU is installed.
- FCU : determines if FCU is installed or not.
- Example : If FCU is set as 'Use', Stop temp. setting is disabled. However, if actually FCU is NOT installed in the water loop, the unit operates continuously in cooling mode until water temperature meets desired temperature. In this case, a condensed water may form on the floor caused by cold water in the underfloor coil.
- Example : If Stop temp. is set as '20' and FCU is set as 'Not use' and actually FCU is installed in the water loop, then the Stop temp. is used and the unit stops operation in cooling mode when the leaving water temperature is below 20 °C. As a result, the unit may not offer enough cooling since the cold water with desired temperature doesn't flow into the FCU.



CAUTION

FCU Installation

- If FCU is used, related 2way valve should be installed and connected to the unit PCB.
- If FCU is set as 'Use' whereas FCU or 2way valve is NOT installed, the unit can do abnormal operation.

Hysteresis Room Air(Cooling)

It is a function to adjust the cooling air temperature Thermal On / Off temperature according to the field environment in order to offer optimized cooling operation.

- In the Installer setting list, and select Hysteresis Room Air(Cooling) setting category, and press [OK] button to move to the detail screen.

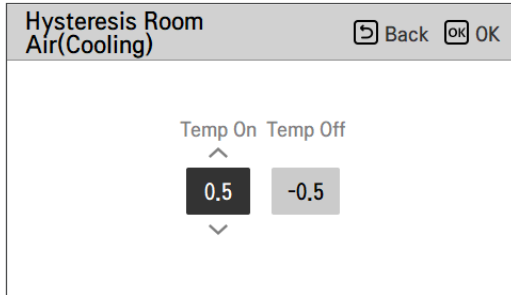
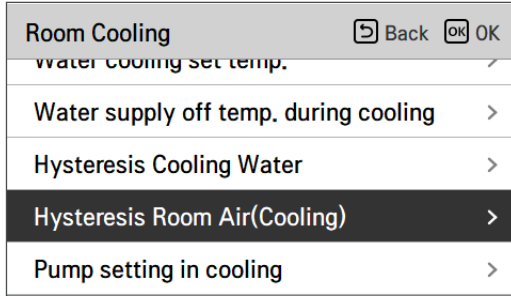

Type	Default (°C)	Range (°C)
Temp On	0.5	3 ~ 0
Temp Off	-0.5	0 ~ -3

Hysteresis Cooling Water

It is a function to adjust the cooling water temperature Thermal On / Off temperature according to the field environment in order to offer optimized cooling operation.

- In the Installer setting list, and select Hysteresis Cooling Water setting category, and press [OK] button to move to the detail screen.

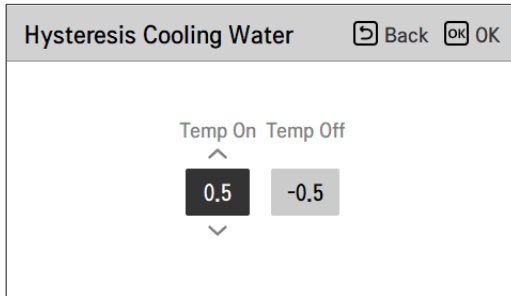
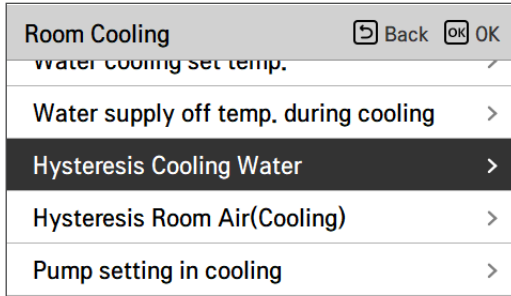

Type	Default (°C)	Range (°C)
Temp On	0.5	3 ~ 0
Temp Off	-0.5	0 ~ -3

Cooling temp. setting

- At the water control in cooling mode, the control reference water temperature position setting
- If the air / leaving water temperature selection setting is set to leaving water temperature
- Change setting values using [,<,>(left/right)] button.
- The function is not available for some products.

Room Cooling		Back	OK
Cooling temp. setting		< Outlet >	
Air cooling set temp.	>		
Water cooling set temp.	>		
Water supply off temp. during cooling	>		
Hydronic Cooling Water	>		

Value	
Outlet (Default)	Inlet

Pump setting in cooling

- It is a function to help the water pump's mechanical life by putting the water pump's rest time
- Installer setting function to set water pump on/off interval option during thermo off condition in cooling mode.
- In the installer setting list, select Pump setting in cooling category, and press [OK] button to move to the detail screen.

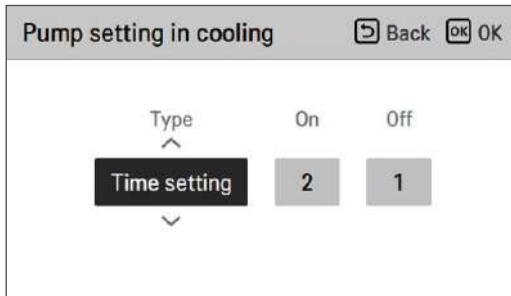
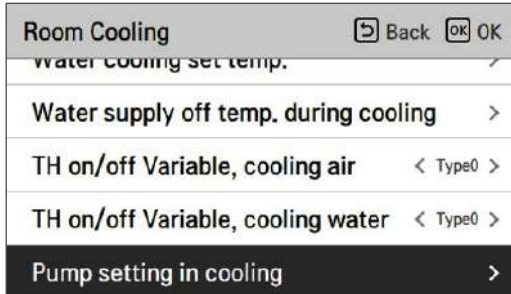

Type	On	Off
Time setting (Default)	1 ~ 60 min (Default : 2 min)	1 ~ 60 min (Default : 1 min)
Operation continue	-	-

Seasonal auto temp.

It is the function to set the operation reference value in Seasonal Auto mode.

- In the installer setting list, select Seasonal auto temp category, and press [OK] button to move to the detail screen.

The following steps illustrate the navigation through the Seasonal auto temp settings:

- Auto Mode**: The 'Seasonal auto temp' option is selected.
- Seasonal auto temp**: The 'Mode' is set to 'Heat & Cool'.
- Seasonal auto temp**: The 'Outdoor Temp.' option is selected.
- Outdoor Temp.**: A graph is shown for setting the outdoor temperature. The x-axis is 'Outdoor Temp.' ranging from -30 to 50. A red dot is set at -10. The y-axis is 'Target Temp.' ranging from 0 to 80. The legend indicates 'Air' with a sun icon and 'Water' with a snowflake icon.
- Seasonal auto temp**: The 'Target Temp.' option is selected.
- Target Temp.**: A graph is shown for setting the target temperature for 'Circuit1' and 'Circuit2'. The x-axis is 'Outdoor Temp.' ranging from -30 to 50. The y-axis is 'Target Temp.' ranging from 0 to 80. The legend indicates 'Water' with a sun icon and 'Reference Temp.' with a snowflake icon. A red line is set for Circuit1 and a blue line is set for Circuit2.

Function	Description	Range	Default (Circuit1)	Default (Circuit2)	Boundary
Outdoor1,Heat (Out1)	Heating lower ambient temp	-25 ~ 35 °C	-10 °C		Out1 ≤ Out2-1
Outdoor2,Heat (Out2)	Heating higher ambient temp		18 °C		Out2 ≥ Out1 +1 Out2 ≤ Out3 -5
Outdoor3,Cool (Out3)	Cooling lower ambient temp	10 ~ 46 °C	30 °C		Out3 ≥ Out2 +5 Out3 ≤ Out4 -1
Outdoor4,Cool (Out4)	Cooling higher ambient temp		40 °C		Out4 ≥ Out3 +1
Water1,Heat (LW1)	Heating higher water temp	Use heater : LW STD : 15~65 °C EW STD : 15~55 °C Not use heater : LW STD : 20~65 °C EW STD : 20~55 °C	50 °C	35 °C	LW1 ≥ LW2
Water 2,Heat (LW2)	Heating lower water temp		40 °C	28 °C	LW1 ≥ LW2
Water3,Cool (LW3)	Cooling higher water temp	Use FCU & 5 °C IDU : LW STD : 5~27 °C EW STD : 10~27 °C Use FCU & 6 °C IDU : LW STD : 6~27 °C EW STD : 11~27 °C Not use FCU : LW STD : 16~27 °C EW STD : 20~27 °C	12 °C	18 °C	LW3 ≥ LW4
Water4,Cool (LW4)	Cooling lower water temp		10 °C	16 °C	LW3 ≥ LW4
Air 1, Heat (RA1)	Heating higher air temp	16 ~ 30 °C	21 °C		RA1 ≥ RA2
Air 2, Heat (RA2)	Heating lower air temp		19 °C		RA1 ≥ RA2
Air 3, Cool (RA3)	Cooling higher air temp	18 ~ 30 °C	21 °C		RA3 ≥ RA4
Air 4, Cool (RA4)	Cooling lower air temp		19 °C		RA3 ≥ RA4

- Setting range: Celsius
- Seasonal Auto Driving mode: Heating, Heating & Cooling
- * If heating mode is selected, heating & cooling or cooling can not be selected.
- Depending on the air / outflow control selection value, the water / air related setting value is displayed on the screen.

In this mode, setting temperature will follow outdoor temperature automatically. This mode adds the cooling season function to the conventional weather dependent operation mode.

	Auto-Adjustable Target Temp.	Room Air Temp.(°C)	Leaving Water Temp.	Outdoor Air Temp.	
Heating	Set point 1	30~20	57~39	Set point 5	-20 ~ -10
	Set point 2	19~16	38~20	Set point 6	-5 ~ 5
Cooling	Set point 3	30~24	25~17	Set point 7	10 ~ 18
	Set point 4	23~18	16~6	Set point 8	22 ~ 30

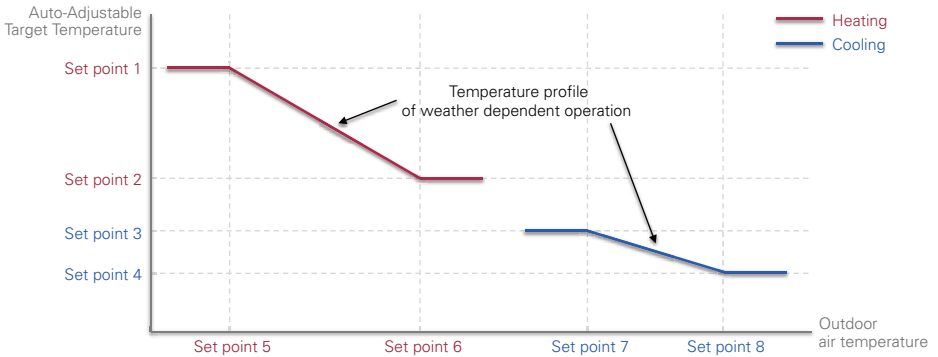

Heater priority

- Heater priority : Determine usage of backup heater and booster heater.
- Example : If Heater priority is set as 'Main+Boost heater ON', then backup heater and booster heater are on and off according to control logic. If Heater priority is set as 'Boost heater only ON', then backup heater is never turned on and only booster heater is on and off according to control logic.
- In the installer setting list, heater priority category, and press [OK] button to move to the detail screen.

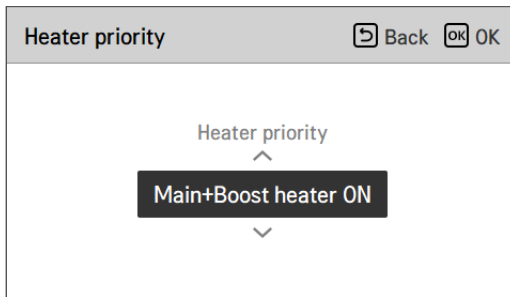
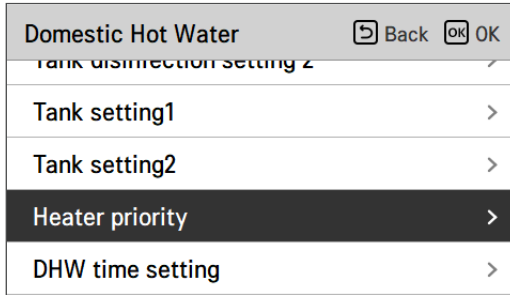

Value	
Boost heater only ON	Main+Boost heater ON (Default)

DHW set temp.

Determine heating setting temperature range when DHW temperature is selected as setting temperature

- In the installer setting list, select DHW set temp. category, and press [OK] button to move to the detail screen.

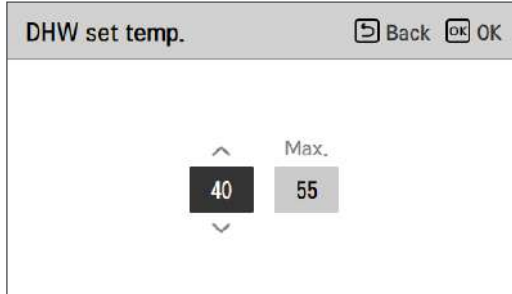
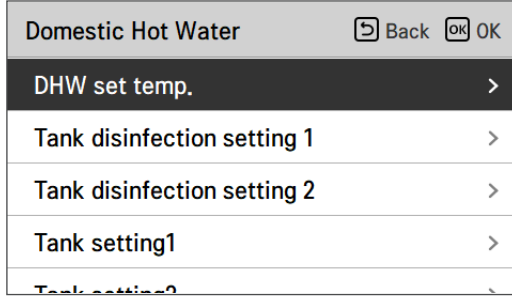

Value	Default (°C)	Range (°C)
Max.	55	80 ~ 50
Min.	40	40 ~ 30

Tank disinfection setting 1, 2

- Disinfection operation is special DHW tank operation mode to kill and to prevent growth of legionella inside the tank.
 - Disinfection active : Selecting enable or disable of disinfection operation.
 - Start date : Determining the date when the disinfection mode is running.
 - Start time : Determining the time when the disinfection mode is running.
 - Max temp. : Target temperature of disinfection mode.
 - Duration time : Duration of disinfection mode.

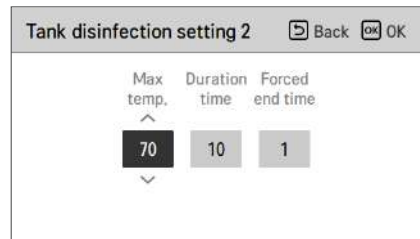
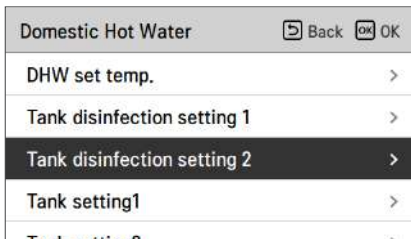
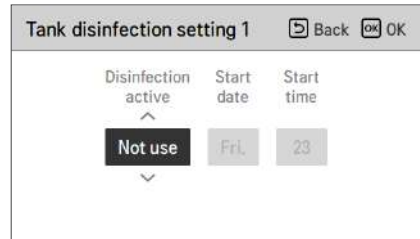
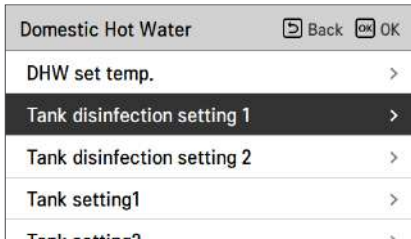
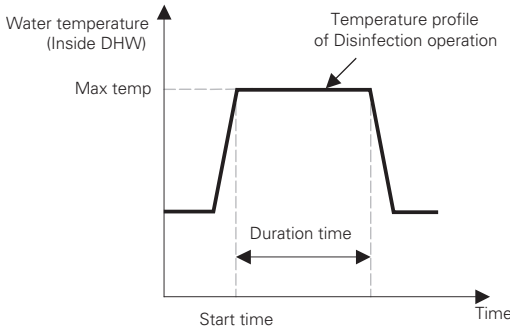

NOTE

DHW heating should be enable

- If Disinfection active is set as ' Not use', that is 'disable disinfection mode', Start date and Start time is not used.

Tank setting 1

- In the installer setting list, select tank setting 1 category, and press [OK] button to move to the detail screen.

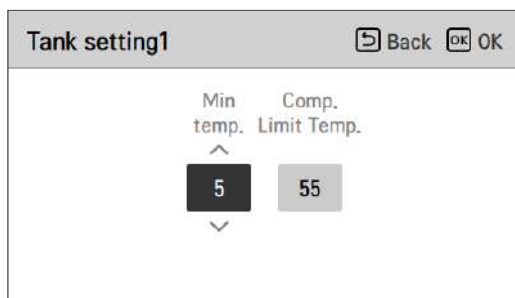
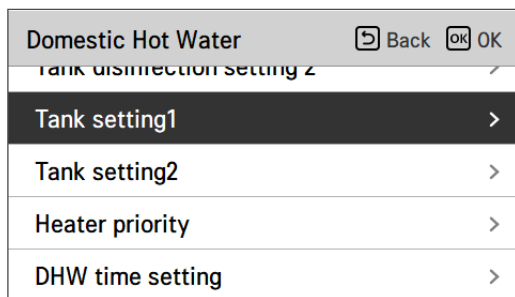

Value	Default (°C)	Range (°C)
Min. temp.	5	30 ~ 1
Comp. Limit Temp.	55	58 ~ 40

Tank setting 2

- In the installer setting list, select tank setting 2 category, and press [OK] button to move to the detail screen.

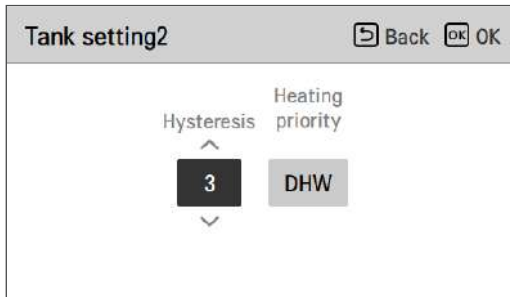
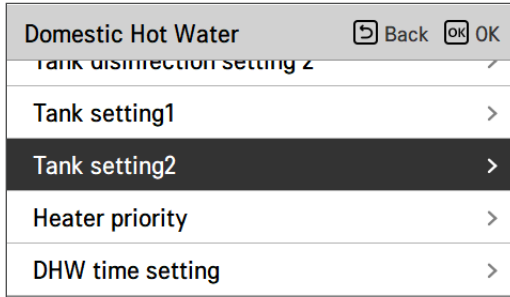

Value	Range
Hysteresis	4~2
Heating priority	Floor heating / DHW

• Tank setting 1, 2

Descriptions for each parameters are as following.

- Min temp. : temperature gap from Max outdoor temp.
- Max outdoor temp. : maximum temperature generated by AWHP compressor cycle.
- Example : If Min temp. is set as '5' and Max outdoor temp. is set as '48', then Session A (see the graph) will be started when the water tank temperature is below 43 °C.... If temperature is above 48 °C..., then Session B will be started.
- Hysteresis : temperature gap from target DHW temperature. This value is required to prevent frequent On and Off of booster heater.
- Heating priority : Determining heating demand priority between DHW tank heating and under floor heating.
- Example : If user's target temperature is set as '70' and Hysteresis is set as '3', then the booster heater will be turned off when the water temperature is above 73 °C. The booster heater will be turned on when the water temperature is below 70 °C.
- Example : If Heating priority is set as 'DHW', that means heating priority is on DHW heating, DHW is heated by AWHP compressor cycle and booster heater. In this case the under floor can not be heated while DHW heating. On the other hand, if the Heating priority is set as 'Floor heating', that means heating priority is on under floor heating, DHW tank is ONLY heated by booster heater. In this case the under floor heating is not stopped while DHW is heated.

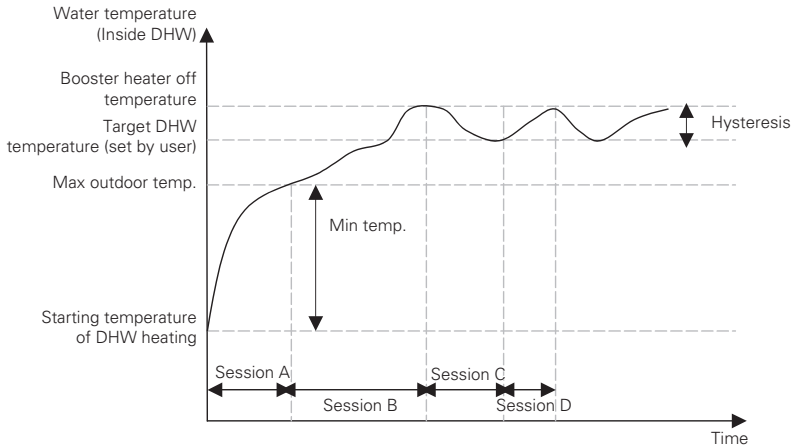

Session A : Heating by AWHP compressor cycle and booster heater

Session B : Heating by booster heater

Session C : No heating (booster heater is Off)

Session D : Heating by booster heater

NOTE

DHW heating does not operate when it is disabled.

DHW time setting

Determine following time duration : operation time of DHW tank heating, stop time of DHW tank heating, and delay time of DHW tank heater operating.

- Active time : This time duration defines how long time DHW tank heating can be continued.
- Stop time : This time duration defines how long time DHW tank heating can be stopped. It is also regarded as time gap between DHW tank heating cycle.
- Boost heater delay time : This time duration defines how long time DHW tank heater will not be turned on in DHW heating operation.
- Example of timing chart :

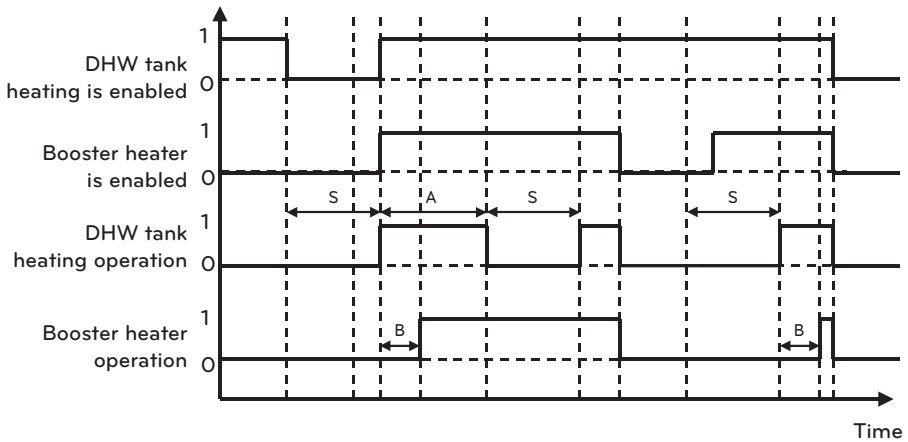

- * 1=active / 0=not active
- * A = Active time
- * S = Stop time
- * B = Boost heater delay time



Value	Default	Range
Active time	30 min	5~95 min
Stop time	30 min	0~600 min

Recirculation time (For Split Indoor unit 5 Series, Hydrosplit 2-Pipe)

- It is function to set recirculation water pump on/off interval option
- In the installer setting list, select Recirculation time category, and press [OK] button to move to the detail screen.

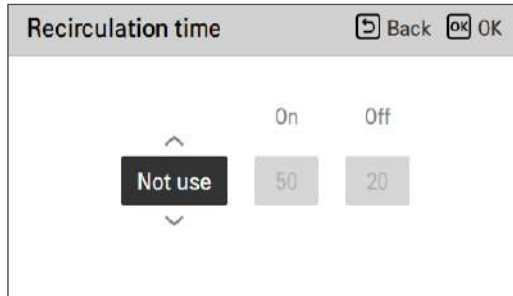
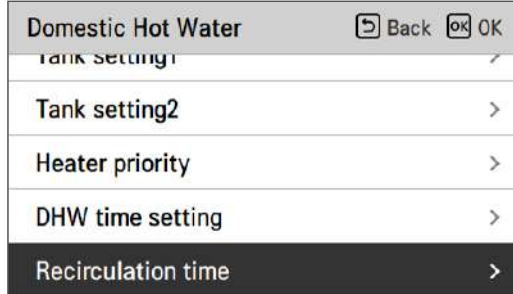

Value	Default	Range
DHW recirculation	Not use	Use / Not use
ON Time	10 min	1 ~ 60 min
OFF Time	20 min	1 ~ 60 min

Solar Thermal System

It is function to set operation reference value in Solar Thermal System.

In the installer setting list, select Solar thermal system category, and press [OK] button to move to the detail screen.

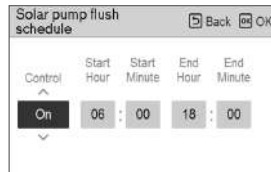
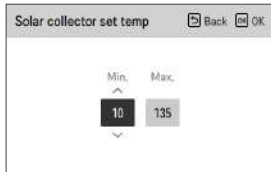
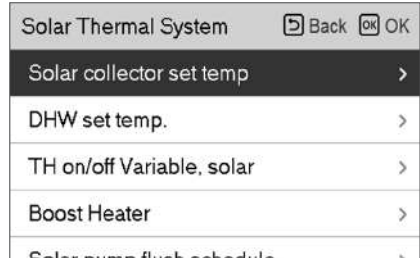
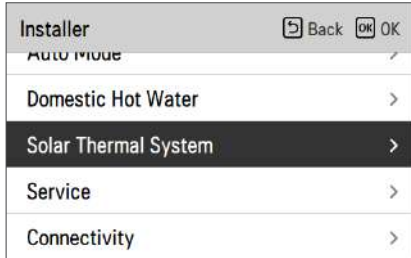

NOTE

To use this function, switch No.2 of option switch 2 must be turned ON and No.3 of option switch 2 must be turned OFF.

Descriptions for each parameters are as following.

- Solar collector set temp
 - Min temp : It is the minimum solar collector temperature at which the solar thermal system can operate.
 - Max temp : It is the maximum solar collector temperature at which the solar thermal system can operate.
- TH on/off Variable, solar
 - Temp on : It is the temperature difference between the current solar thermal temperature and DHW tank temperature at which the solar thermal system operates.
 - Temp off : It is the temperature difference between the current solar thermal temperature and DHW tank temperature at which the solar thermal system stops.
 - Example : If the current solar collector temperature is 80 °C and Temp on is set to 8 °C, the solar thermal system operates when the DHW tank temperature is less than 72 °C. In the same case, if Temp off is set to 2 °C, Solar Thermal System stops when DHW temperature is 78 °C.
- DHW Set Temp
 - Max : It is maximum temperature of DHW that can be reached by solar thermal system.
- Boost Heater
 - Enable : Booster heater can be used when operating the Solar Thermal system.
 - Disable : Booster heater cannot be used when operating the Solar Thermal system.
- Solar pump flush schedule
 - It is the function to circulate the solar water pump intermittently for solar collector temperature detection when the solar water pump does not operate for a long time. Turn on to use this function.
- Solar Pump flush setting
 - Oper.Cycle : When using the solar pump flush function, the solar water pump operates at the set time.
 - Oper.Time : When using the solar pump flush function, the solar water pump operates during the set time.

Function	Value	Range	Default
Solar collector set temp	Min	5 °C ~ 50 °C	10 °C
	Max	60 °C ~ 200 °C	95 °C
DHW set temp	Max	20 °C ~ 90 °C	80 °C
TH on/off Variable, solar	Temp On	3 °C ~ 40 °C	8 °C
	Temp Off	1 °C ~ 20 °C	2 °C
Boost Heater	Boost Heater	Enable/Disable	Enable
Solar pump flush schedule	On/OFF	On/Off	On
	Start Hour, Start Minute	00:00 ~ 24:00	6:00
	End Hour, End Minute	00:00 ~ 24:00	18:00
Solar pump test run	Pump test Run	Start/Stop	Stop
Solar pump flush setting	Oper.Cycle	30 min ~ 120 min	60 min
	Oper.Time	1 min ~ 10 min	1 min

Pump test run

The pump test run is to test run by operating the water pump for 1 hour.

This function can be used for air purging through air vents and checking flow rate and others.

- In the installer setting list, Pump Test run category, and press [OK] button to move to the detail screen.

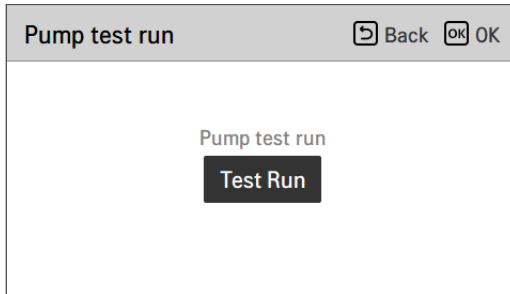
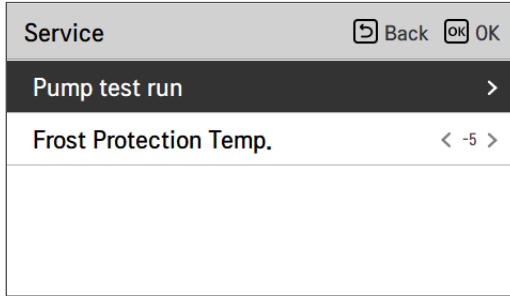

Frost Protection Temp.

This function prevents the unit from freezing. This function sets the freeze protection temperature according to the concentration injected after injecting antifreeze.

- Change setting values using [\leftarrow , \rightarrow (left/right)] button.
- The function is not available for some products.

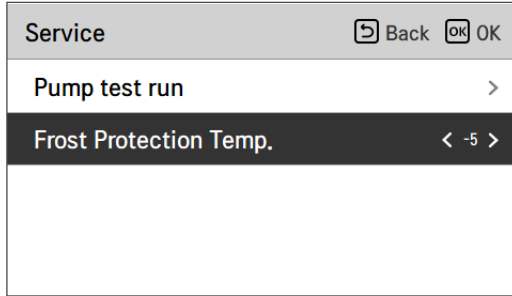

Range (°C)	Default (°C)
-25 ~ -5	-5

NOTE

To use this function, the antifreeze short pin (CN_ANTI_SW) must be open and switch No.8 in Option SW 1 must be on.

Antifreeze short pin

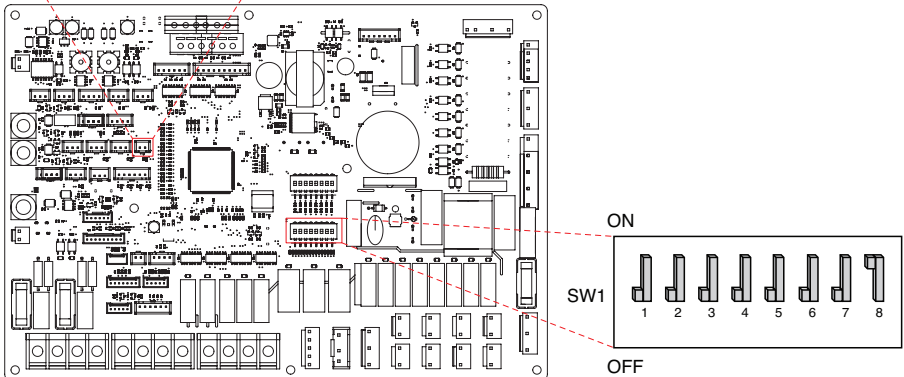
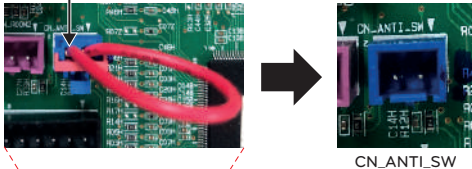

Dry Contact Mode

Dry contact function is the function that can be used only when the dry contact devices is separately purchased and installed.

- Change setting values using [,>,(left/right)] button.

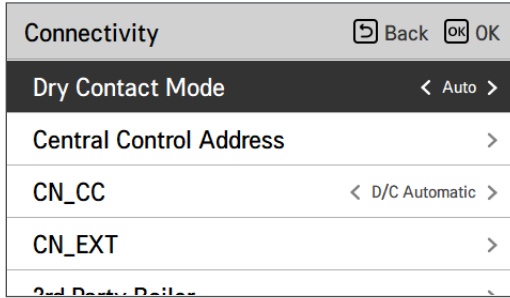

Value	Description
Auto (Default)	Automatically operation ON with release hard lock
Manual	Keep operation OFF with hard lock

NOTE

For dry contact mode related detail functions, refer to the individual dry contact manual.

What is dry contact?

It means the contact point signal input when the hotel card key, human body detection sensor, etc. are interfacing with the unit.

Added system functionality by using external inputs (dry contacts and wet contacts).

Central Control Address

When connecting the central control, set the central control address of the unit.

- In the installer setting list, select Central Control Address category, and press [OK] button to move to the detail screen.

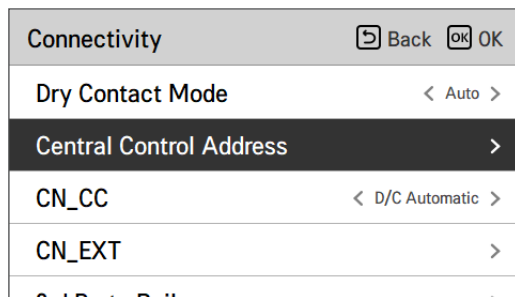

NOTE

Enter address code as hexadecimal value
 Front: Central Control Gr. No.
 Back side: Central control indoor the number

NOTE

This function is not available for monobloc

CN_CC

It is the function to set the usage of the unit's CN_CC port.

- Change setting values using [<,>(left/right)] button

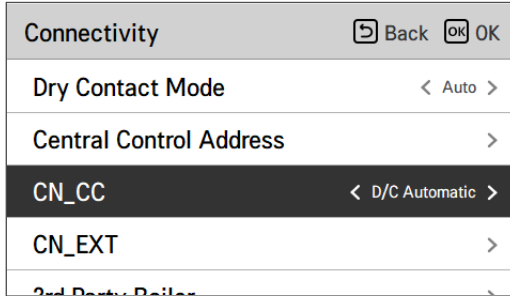

Value	Description
D/C Automatic (Default)	When power is applied to the product, the unit when the contact point is on in Dry Contact installed state recognizes Dry Contact installation
D/C Not Installed	Do not use (install) Dry Contact
D/C Installed	Use (install) Dry Contact

NOTE

CN_CC is the device connected to the unit to recognize and control the external contact point.

Energy state

This function is to control the product according to the energy state. When the charged state of ESS is transmitted, it changes the target temperature of heating, cooling and DHW by setting value according to energy state.

Select either Signal Mode or Modbus Mode according to the connection type between the product and the ESS.

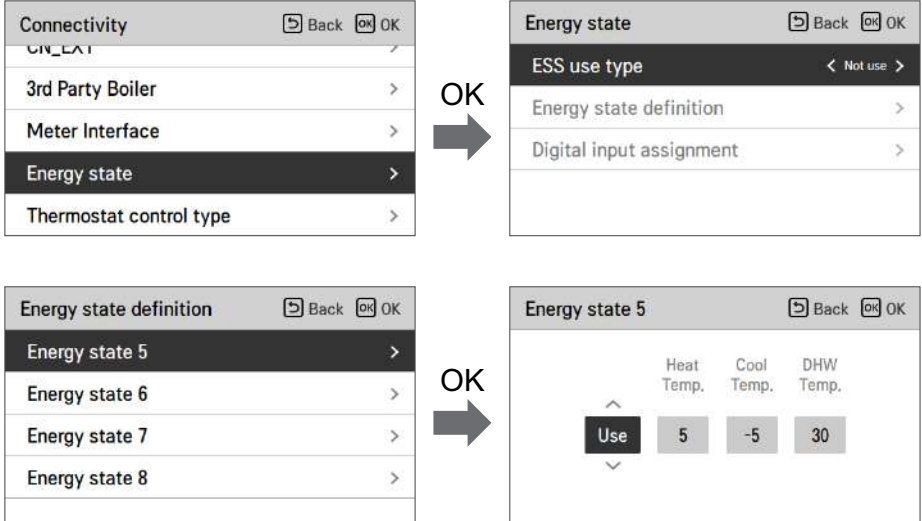

When Signal Mode of EES use type is selected, press the Digital Input Assignment button to set the energy state according to the input signal.

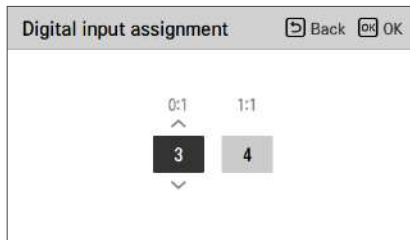

Value	Input Signal		Output state	
	TB_SG1	TB_SG2	Default	Range
X	0	0	ES2	fixed
X	1	0	ES1	fixed
0:1	0	1	ES3	ES3-ES8
1:1	1	1	ES4	

Thermostat control type

It is a function to enable installer to control Water Pump Options using water flow sensor.

- In the Installer setting list, and select Connectivity category, and press [OK] button to move to the detail screen.

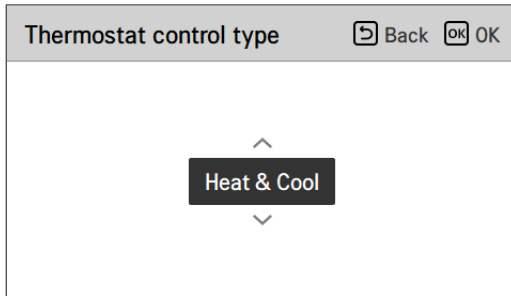
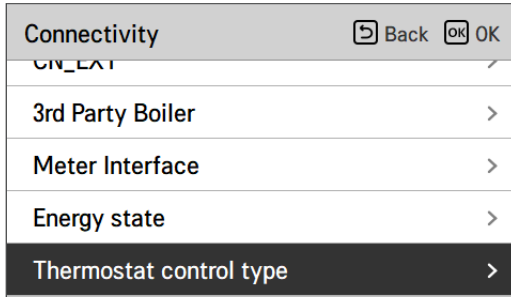

Type	
Heat & Cool (Default)	Heat & Cool / DHW

Pump operation time

It is a function to show the water pump's operation time for check mechanical life.

- In the Installer setting list, and select Information category, and press [OK] button to move to the detail screen.

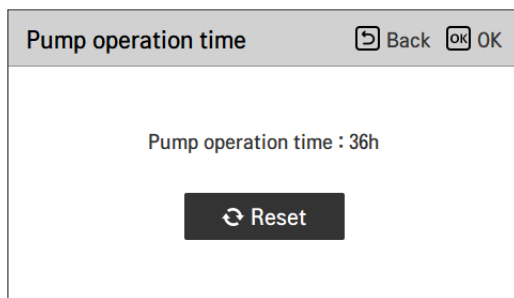
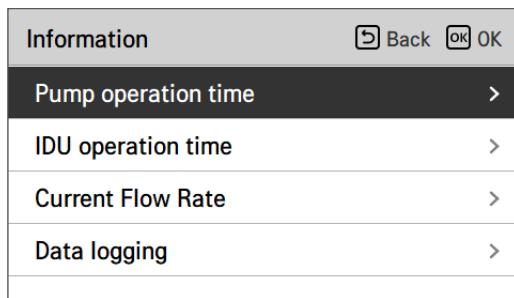

IDU operation time

It is a function to show the Indoor Unit's operation time for check mechanical life.

- In the Installer setting list, and select Information category, and press [OK] button to move to the detail screen.

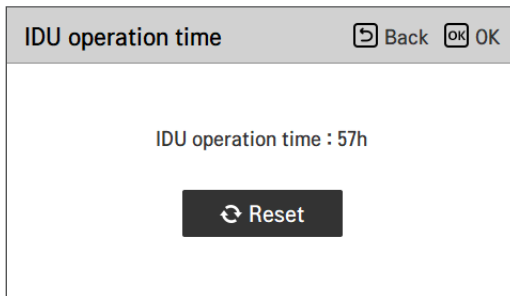
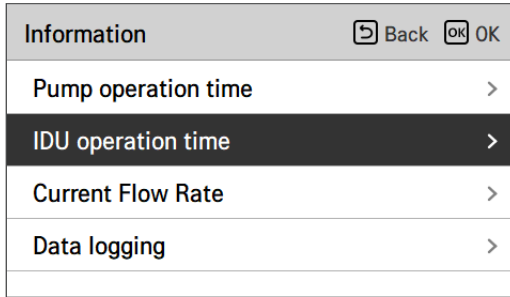

Modbus Address

It is function to set the address of the Modbus device that is externally linked to the product. Modbus address setting function is available from indoor unit.

- In the installer setting list, select Modbus Address , and press [OK] button to move to the detail screen.

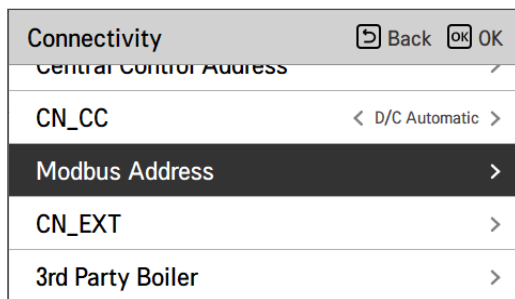

NOTE

To use this function, switch No.1 of option switch 1 must be turned ON.

Modbus gateway memory map

Baud Rate : 9 600 bps Stop Bit : 1 stop bit Parity : None Parity

Coil Register (0x01)

Register	Description	Value explanation
00001	Enable/Disable (Heating/Cooling)	0 : Operation OFF / 1 : Operation ON
00002	Enable/Disable (DHW)	0 : Operation OFF / 1 : Operation ON
00003	Silent Mode Set	0 : Silent mode OFF / 1 : Silent mode ON
00004	Trigger Disinfection operation	0 : Keep status / 1 : Operation start
00005	Emergency Stop	0 : Normal operation / 1 : Emergency stop
00006	Trigger Emergency Operation	0 : Keep status / 1 : Operation Start

Discrete Register (0x02)

Register	Description	Value explanation
10001	Water flow status	0 : Flow rate ok / 1 : Flow rate too low
10002	Water Pump status	0 : Water Pump OFF / 1 : Water Pump ON
10003	Ext. Water Pump status	0 : Water Pump OFF / 1 : Water Pump ON
10004	Compressor status	0 : Compressor OFF / 1 : Compressor ON
10005	Defrosting status	0 : Defrost OFF / 1 : Defrost ON
10006	DHW heating status (DHW Thermal On/Off)	0 : DHW inactive / 1 : DHW active
10007	DHW Tank disinfection status	0 : Disinfection inactive / 1 : Disinfection active
10008	Silent mode status	0 : Silent mode inactive / 1 : Silent mode active
10009	Cooling status	0 : No cooling / 1 : Cooling operation
10010	Solar pump status	0 : Solar pump OFF / 1 : Solar pump ON
10011	Backup heater (Step 1) status	0 : OFF / 1 : ON
10012	Backup heater (Step 2) status	0 : OFF / 1 : ON
10013	DHW boost heater status	0 : OFF / 1 : ON
10014	Error status	0 : no error / 1 : error state
10015	Emergency Operation Available (Space heating/cooling)	0 : Unavailable / 1 : Available
10016	Emergency Operation Available (DHW)	0 : Unavailable / 1 : Available
10017	Mix pump status	0 : Mix pump OFF / 1 : Mix pump ON

Holding Register (0x03)

Register	Description	Value explanation
30001	Error Code	Error Code
30002	ODU operation Cycle	0 : Standby(OFF) / 1 : Cooling / 2 : Heating
30003	Water inlet temp.	[0.1 °C ×10]
30004	Water outlet temp.	[0.1 °C ×10]
30005	Backup heater outlet temp.	[0.1 °C ×10]
30006	DHW tank water temp.	[0.1 °C ×10]
30007	Solar collector temp.	[0.1 °C ×10]
30008	Room air temp. (Circuit 1)	[0.1 °C ×10]
30009	Current Flow rate	[0.1 LPM ×10]
30010	Flow temp. (Circuit 2)	[0.1 °C ×10]
30011	Room air temp. (Circuit 2)	[0.1 °C ×10]
30012	Energy State input	0 : Energy state 0; 1: Energy state 1....
30013	Outdoor Air temp.	[0.1 °C ×10]
39998	Produc Group	0x8X (0x80, 0x83, 0x88, 0x89)
39999	Product Info.	Split : 0 / Monobloc : 3 / High Temp. : 4 / Medium Temp. : 5 / System Boiler : 6

Input Register (0x04)

Register	Description	Value explanation
40001	Operation Mode	0 : Cooling / 4 : Heating / 3 : Auto
40002	Control method (Circuit 1/2)	0 : Water outlet temp. control 1 : Water inlet temp. control 2 : Room air control
40003	Target temp (Heating/Cooling) Circuit 1	[0.1 °C ×10]
40004	Room Air Temp. Circuit 1	[0.1 °C ×10]
40005	Shift value(Target) in auto mode Circuit 1	1K
40006	Target temp (Heating/Cooling) Circuit 2	[0.1 °C ×10]
40007	Room Air Temp. Circuit 2	[0.1 °C ×10]
40008	Shift value(Target) in auto mode Circuit 2	1K
40009	DHW Target temp.	[0.1 °C ×10]
40010	Energy state input	0 : Not Use 1 : Forced off (equal to TB_SG1=close / TB_SG2=open) 2 : Normal operation (equal to TB_SG1=open / TB_SG2=open) 3 : On-recommendation (equal to TB_SG1=open / TB_SG2=close) 4 : On-command (equal to TB_SG1=close / TB_SG2=close) 5 : On-command step 2 (++ Energy Consumption compared to Normal) 6 : On-recommendation Step 1 (+ Energy Consumption compared to Normal) 7 : Energy Saving mode (- Energy Consumption compared to Normal) 8 : Super Energy saving mode (– Energy Consumption compared to Normal)

CN_EXT

It is a function to control external input and output according to DI type set by customer using CN-EXT Port.

- In the installer setting list, select CN-EXT Port category, and press [OK] button to move to the detail screen.

Connectivity		Back	OK
Dry Contact Mode	< Auto >		
Central Control Address	>		
CN_CC	< D/C Automatic >		
CN_EXT	>		
2nd Party Boiler	>		



CN_EXT		Back	OK
Not use	Simple Operation		
Simple Dry Contact	Single emergency stop		

Value			
Not use (Default)	Simple Operation	Simple Dry Contact	Single emergency stop

3rd Party Boiler

This function is to configure the 3rd party boiler to be controlled.



If the status of this function is "Use", you can choose control mode of boiler, Auto or Manual.

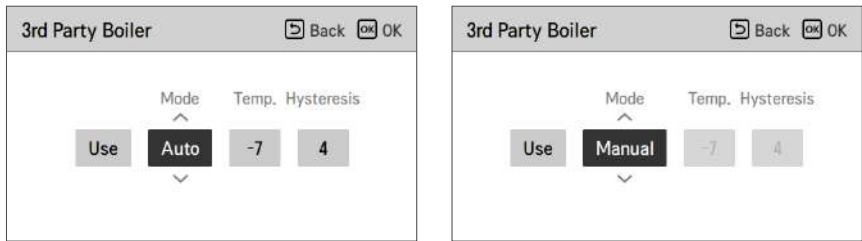

If the mode of this function is set to "Auto", you can set temperature of the boiler and hysteresis, respectively.

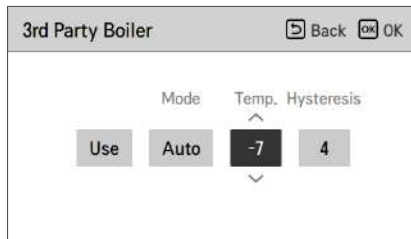

External boiler ON condition :

- If outdoor temperature \leq external boiler operation temperature value (installer setting), turn off the indoor unit and operate the external boiler.

External boiler OFF condition :

- If External air temperature \geq external boiler operation temperature value (installer setting) + Hysteresis (installer setting), turn off external boiler operation and operate indoor unit

Meter Interface

It is the function that can check the status of energy and power on screen. It collects and calculates power or calorie data to create data for energy monitoring and energy warning alarm pop-ups. This function can be activated in installer mode.

Connectivity Back OK

CONNECT

3rd Party Boiler >

Meter Interface >

Energy state >

Thermostat control type >

Meter Interface Back OK

Modbus Address >

Unit >



Modbus Address Back OK

Modbus Address

Not use

Modbus Address Back OK

Modbus Address

B0

Modbus Address Back OK

Modbus Address

B1

There are 2 options, modbus address and unit, in this function. Activating the modbus address option, you choose one address(B0 or B1) or don't use. Then, you set the port and specification in range of 0000.0~9999.9[pulse/kWh] as shown in the figure below.

Unit Back OK

Pulse/kWh

Port1 0 0 0 0 . 0

Unit Back OK

Pulse/kWh

Port1 1 1 1 1 . 1

Current flow rate

It is the function to check the current flow rate.

- In the installer setting list, select Current Flow Rate category, and press [OK] button to move to the detail screen. The current flow rate can be checked. (Range : 7 ~ 80 L/min)
- The function is not available for some products.

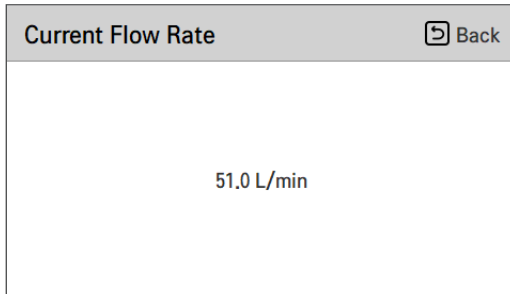
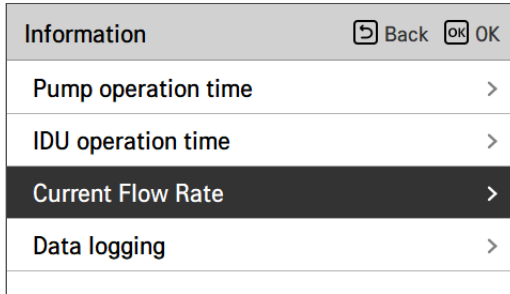

Data logging

This function is to check the operation and error history.

- In the installer setting list, select Data logging category, and press [OK] button to move to the detail screen.

Information	Back	OK
Pump operation time	>	
IDU operation time	>	
Current Flow Rate	>	
Data logging	>	



Data logging					Back
Date	Time	Oper.	Settemp	In/Out	
2020.07.02	03:01	Cool	16°	25° / 25°	
2020.07.02	02:57	Cool	16°	25° / 25°	
2020.07.02	02:31	Cool	16°	25° / 25°	>
2020.07.02	02:27	Cool	16°	25° / 25°	
2020.07.02	02:01	Cool	16°	25° / 25°	

NOTE

Error history lookup range: 50

Error history information

Item: date, time, mode (including Off), set temperature, incoming temperature, outgoing temperature, room temperature, Hot water operation / stop, Hot water set temperature, Hot water temperature, Outdoor unit On / Off, Error code

Number of Display: Within 50

- Save criteria ▾

▸ Error occurred, released ON / OFF of outdoor unit operation.

COMMISSIONING

If everything is going well until now, it is time to start the operation and to take advantages of **THERMAV**.

Before starting operation, pre-check points are described in this chapter. Some comments about maintenance and how to do troubleshooting are presented.

Check List before Starting Operation



CAUTION

Turn off the power before changing wiring or handling product.

No	Category	Item	Check Point
1	Electricity	Field wiring	<ul style="list-style-type: none"> All switches having contacts for different poles should be wired tightly according to regional or national legislation. Only qualified person can proceed wiring. Wiring and local-supplied electric parts should be complied with European and regional regulations. Wiring should be following the wiring diagram supplied with the product.
2		Protective devices	<ul style="list-style-type: none"> Install ELB (earth leakage breaker) with 30 mA. ELB inside the control box of the unit should be turned on before starting operation.
3		Earth wiring	<ul style="list-style-type: none"> Earth should be connected. Do not earth to gas or city water pipe, metallic section of a building, surge absorber, etc.
4		Power supply	<ul style="list-style-type: none"> Use dedicated power line.
5		Terminal block wiring	<ul style="list-style-type: none"> Connections on the terminal block (inside the control box of the unit) should be tightened.
6	Water	Charged water pressure	<ul style="list-style-type: none"> After water charging, the pressure gauge (in front of the unit) should indicate 2.0~2.5 bar. Do not exceed 3.0 bar.
7		Air purge	<ul style="list-style-type: none"> During water charging, air should be taken out through the hole of the air purge. If water does not splash out when the tip (at the top of the hole) is pressed, then air purging is not completed yet. If well purged, the water will splash out like fountain. Be careful when testing air purge. Splashed water may make your dress wet.
8		Shut-off valve	<ul style="list-style-type: none"> Two shut-off valves (located at the end of water inlet pipe and water outlet pipe of the unit) should be open.
9		By-pass valve	<ul style="list-style-type: none"> By-pass valve should be installed and adjusted to secure enough water flow rate. If water flow rate is low, flow switch error (CH14) can be occurred.
10	Product Installation	Hang to the wall	<ul style="list-style-type: none"> As the unit is hung on the wall, vibration or noise can be heard if the unit is not fixed tightly. If the unit is not fixed tightly, it can fall down during operation.
11		Parts inspection	<ul style="list-style-type: none"> There should be no apparently damaged parts inside the unit.
12		Refrigerant leakage	<ul style="list-style-type: none"> Refrigerant leakage degrades the performance. If leakage found, contact qualified LG air conditioning installation person.
13		Drainage treatment	<ul style="list-style-type: none"> While cooling operation, condensed dew can drop down to the bottom of the unit. In this case, prepare drainage treatment (for example, vessel to contain condensed dew) to avoid water drop.

To assure best performance of **THERMAV**, it is required to perform periodical check and maintenance. It is recommended to proceed following check list for once a year.



CAUTION

Turn off the power before proceeding maintenance.

No	Category	Item	Check Point
1	Water	Water pressure	<ul style="list-style-type: none"> • In normal state, the pressure gauge (in front of the unit) should indicate 2.0~2.5 bar. • If the pressure is less than 0.3 bar, please recharge the water.
2		Strainer (Water filter)	<ul style="list-style-type: none"> • Close the shut-off valves and disassemble strainer. Then wash the strainer to make it clean. • While disassembling the strainer, be careful for water flood out.
3		Safety valve	<ul style="list-style-type: none"> • Open the switch of the safety valve and check if water is flood out through the drain hose. • After checking, close the safety valve.
4	Electricity	Terminal block wiring	<ul style="list-style-type: none"> • Look and inspect if there is loosen or defected connection on the terminal block.

Starting Operation

Check before Starting Operation

1	Check to see whether there is any refrigerant leakage, and check whether the power or transmission cable is connected properly.
2	<p>Confirm that 500 V megger shows 2.0 MΩ or more between power supply terminal block and ground. Do not operate in the case of 2.0 MΩ or less.</p> <p>NOTE: Never carry out mega ohm check over terminal control board. Otherwise the control board may break.</p> <p>Immediately after mounting the unit or after leaving it turned off for an extended length of time, the resistance of the insulation between the power supply terminal board and the ground may decrease to approx. 2.0 MΩ as a result of refrigerant accumulation in the internal compressor.</p> <p>If the insulation resistance is less than 2.0 MΩ, turn on the main power supply.</p>
3	When the power is applied for the first time, operate the product after preheating for 2 hours. To protect the unit by increasing the oil temperature of the compressor.

Starting Operation flow chart

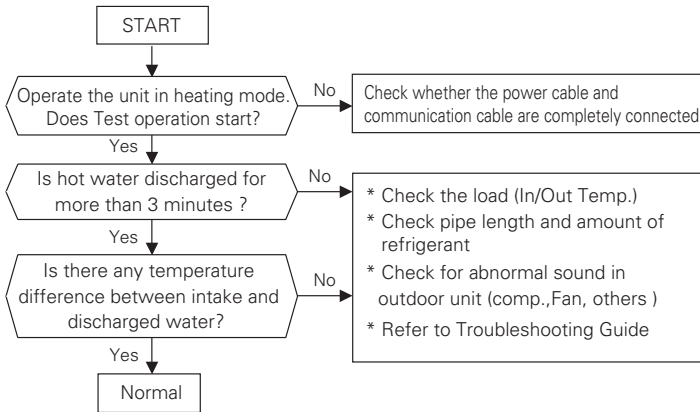

Airborne Noise Emission

The A-weighted sound pressure emitted by this product is below 70 dB.

** The noise level can vary depending on the site.

The figures quoted are emission level and are not necessarily safe working levels.

Whilst there is a correlation between the emission and exposure levels, this cannot be used reliably to determine whether or not further precautions are required.

Factor that influence the actual level of exposure of the workforce include the characteristics of the work room and the other sources of noise, i.e. the number of equipment and other adjacent processes and the length of time for which an operator exposed to the noise.

Also, the permissible exposure level can vary from country to country.

This information, however, will enable the user of the equipment to make a better evaluation of the hazard and risk.

Limiting concentration(For R410A)

Limiting concentration is the limit of Freon gas concentration where immediate measures can be taken without hurting human body when refrigerant leaks in the air. The limiting concentration shall be described in the unit of kg/m^3 (Freon gas weight per unit air volume) for facilitating calculation

Limiting concentration : 0.44 kg/m^3 (For R410A)

■ Calculate refrigerant concentration

$$\text{Refrigerant concentration} = \frac{\text{Total amount of replenished refrigerant in refrigerant facility (kg)}}{\text{Capacity of smallest room where indoor unit is installed (m}^3\text{)}}$$

Vacuum & Charge of Refrigerant

By default, the product was charged of refrigerant.
Vacuum and refrigerant charge, If there is leak refrigerant.

1. Vacuum

To work of vacuum action. when the leak of refrigerant.

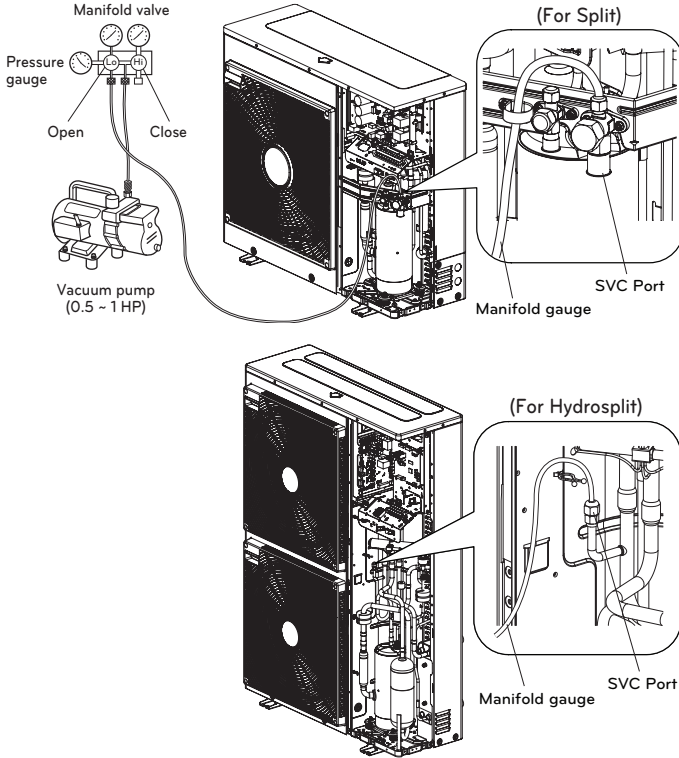

When selecting a vacuum, you should select one which is capable of achieving 0.2 Torr of ultimate vacuum. Degree of vacuum is expressed in Torr, micron, mmHg, and Pascal (Pa). The units correlate as follows:

	Unit	Standard atmospheric pressure	Perfect vacuum
Gauge Pressure	Pa	0	-1.033
Absolute Pressure	Pa	1.033	0
Torr	Torr	760	0
Micron	Micron	760 000	0
mmHg	mmHg	0	760
Pa	Pa	1 013.33	0

2. Charge of refrigerant

You should be charged after vacuum.
 You can see amount of refrigerant at quality label.
 Please to charge at cooling mode when there is not full charging.

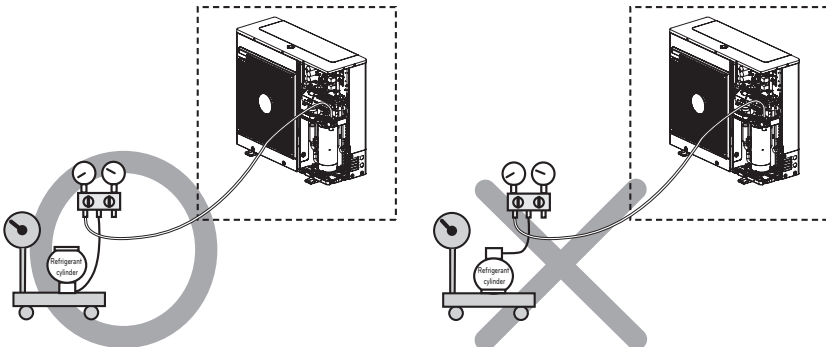
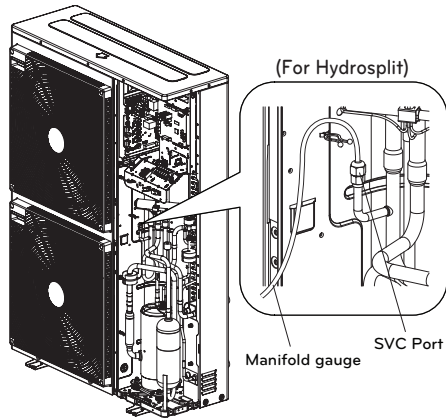
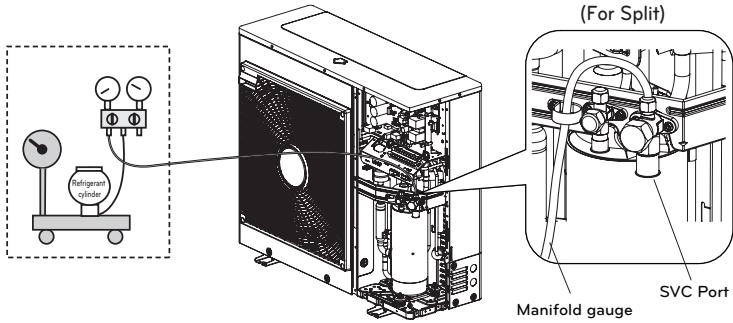

3. Location of SVC port

(For Split)

1Ø : 5 kW, 7 kW, 9 kW

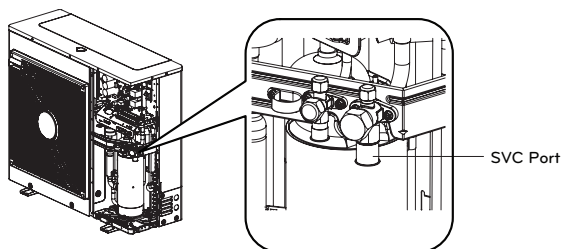

(For Split)

1Ø : 12 kW, 14 kW, 16 kW

3Ø : 12 kW, 14 kW, 16 kW

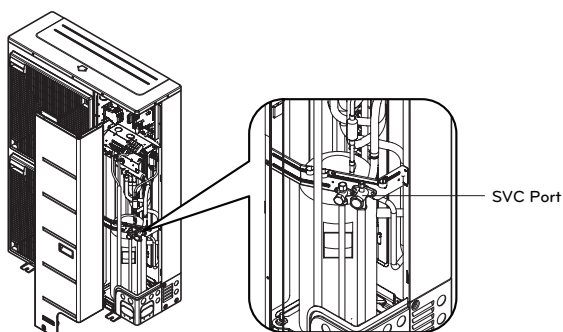

(For Hydrosplit)

1Ø : 12 kW, 14 kW, 16 kW

3Ø : 12 kW, 14 kW, 16 kW

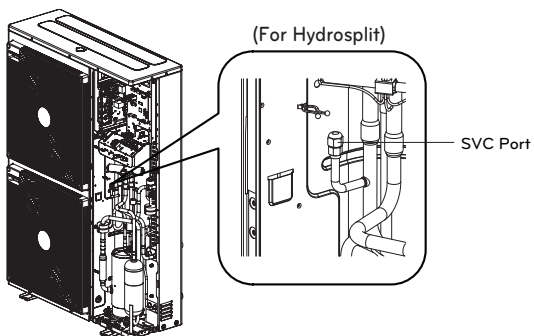

Trouble shooting

If **THERMAV** operates not properly or it does not start operation, please check following list.



CAUTION

Turn off the power before proceeding troubleshooting.

Troubleshooting for Problem while Operation

No	Problem	Reason	Solution
1	Heating or Cooling is not satisfactory.	<ul style="list-style-type: none"> Setting target temperature is not proper. 	<ul style="list-style-type: none"> Set target temperature correctly. Check if temperature is water-based or air-based. See 'Remote sensor active' and 'Temp. sensor selection' in Chapter6.
		<ul style="list-style-type: none"> Charged water is not enough. 	<ul style="list-style-type: none"> Check pressure gauge and charge more water until pressure gauge is indication 2~2.5 Bar
		<ul style="list-style-type: none"> Water flow rate is low. 	<ul style="list-style-type: none"> Check if strainer gathers too much particles. If so, strainer should be cleaned. Check if pressure gauge indicates above 4 Bar Check if water pipe is getting closed due to stacked particles or lime.
2	Although electric power supply is OK (remote controller displays information), the unit does not start working.	<ul style="list-style-type: none"> Water inlet temperature is too high. 	<ul style="list-style-type: none"> If water inlet temperature is above 57 °C, the unit does not operated for the sake of system protection
		<ul style="list-style-type: none"> Water inlet temperature is too low. 	<ul style="list-style-type: none"> If water inlet temperature is below 5 °C in cooling operation, the unit does not operated for the sake of system protection. Wait while unit warms up the water inlet temperature. If water inlet temperature is below 15 °C in heating operation, the unit does not operated for the sake of system protection. Wait while unit warms up to 18 °C the water inlet temperature. If you are not using the back up heater accessory (HA**1M E1), increase the water temperature with the external heat source (heater, boiler). If the problem persists, contact your dealer. If you want to use the screed drying function, be sure to purchase and install back up hater accessories (HA**1M E1).
3	Water pump noise.	<ul style="list-style-type: none"> Air purging is not completely finished. 	<ul style="list-style-type: none"> Open the cap of air purge and charge more water until pressure gauge is indicating 2~2.5 Bar If water does not splash out when the tip(at the top of the hole) is pressed, then air purging is not completed yet. If well purged, the water will splash out like fountain.
		<ul style="list-style-type: none"> Water pressure is low. 	<ul style="list-style-type: none"> Check if pressure gauge indicates above 0.3 Bar. Check if the expansion tank and pressure gauge operates well.
4	Water is flood out through drain hose.	<ul style="list-style-type: none"> Too much water is charged. 	<ul style="list-style-type: none"> Flood out water by opening the switch of the safety valve until pressure gauge is indicating 2~2.5 Bar.
		<ul style="list-style-type: none"> Expansion tank is damaged. 	<ul style="list-style-type: none"> Replace the expansion tank
5	DHW is not hot.	<ul style="list-style-type: none"> Thermal protector of water tank heater is activated. 	<ul style="list-style-type: none"> Open the side panel of the DHW tank and push the reset button of the thermal protector. (for more detail information, please refer to installation manual of DHW tank.
		<ul style="list-style-type: none"> DHW Heating is disabled. 	<ul style="list-style-type: none"> Select DHW Heating Operation and identify if icon is displayed on the remote controller.

Troubleshooting for Error Code

Display code	Title	Cause of error	Check point & Normal condition
1	Problem in remote room air sensor	<ul style="list-style-type: none"> • Incorrect connection between sensor and PCB(Heater). • PCB(Heater) fault • Sensor fault 	<ul style="list-style-type: none"> • Resistance: 10 kΩ at 25 centigrade (unplugged) → for Remote room air sensor • Resistance: 5 kΩ at 25 centigrade (unplugged) → for all sensors EXCEPT remote room air sensor • Voltage: 2.5 V DC at 25 centigrade (plugged) (for all sensors) • Refer resistance-temperature table to check in different temperature
2	Problem in refrigerant (inlet side) sensor		
6	Problem in refrigerant (outlet side) sensor		
8	Problem in water tank sensor		
13	Problem in solar pipe sensor		
16	Problems in sensors		
17	Problem in water-inlet sensor		
18	Problem in water-outlet sensor		
19	Problem in Electric heater outlet sensor		
10	BLDC Water pump Lock	Restriction of BLDC Water pump	<ul style="list-style-type: none"> • BLDC Water pump defect / assembly condition abnormal • Fan lock by foreign material
3	Bad communication between remote controller and unit.	<ul style="list-style-type: none"> • Incorrect connection between sensor and PCB(Heater) • PCB(Heater) fault • Sensor fault 	<ul style="list-style-type: none"> • Wire connection between remote controller and Main PCB assembly(Heater) should be tight • Output voltage of PCB should be 12 V DC
5	Bad communication between Main PCB assembly(Heater) and Main PCB assembly(Inverter) of the unit.	<ul style="list-style-type: none"> • The connector for transmission is disconnected • The connecting wires are misconnected • The communication line is broken • Main PCB assembly(Inverter) is abnormal • Main PCB assembly(Heater) is abnormal 	<ul style="list-style-type: none"> • Wire connection between remote control panel and Main PCB assembly(Heater) should be tight.
53			
9	PCB program (EEPROM) fault	<ul style="list-style-type: none"> • Electrical or mechanical damage a the EEPROM 	<ul style="list-style-type: none"> • This error can not be permitted

Display code	Title	Cause of error	Check point & Normal condition
14	Problem in flow switch and flow sensor (Split Indoor unit 5 Series, Hydrosplit model are follow separate trouble shooting for error code 14.)	<p>Flow switch</p> <ul style="list-style-type: none"> It is open while internal water pump is working. It is closed while internal water pump is not working. It is open while DIP switch No. 5 of Main PCB assembly(Heater) is set as on. <p>Flow sensor</p> <ul style="list-style-type: none"> Water Pump ON. : If flow rate is not more than 7 LPM or not less than 80 LPM, detect it for 15 seconds. Water Pump OFF. : If flow rate is not less than 7 LPM, detect it for 15 seconds. 	<p>Flow switch</p> <ul style="list-style-type: none"> It should be closed while internal water pump is working or DIP switch No. 5 of Main PCB assembly(Heater) is set as on. It should be open while internal water pump is not working. <p>Flow Sensor</p> <ul style="list-style-type: none"> Display the flow rate value that received from the indoor unit. (Range : 7 ~ 80 LPM)
	Problem in Flow rate (For Split Indoor unit 5 Series, For Hydrosplit)	<p>If flow rate is not more than minimum, detect it for 15 seconds during pump operation.</p> <p>- Minimum flow rate : (5, 7, 9 kW) 7 LPM (12, 14, 16 kW) 15 LPM</p>	<ul style="list-style-type: none"> Display the flow rate value on the remote controller. Make sure there is no leakage. Make sure the strainer or water pipe is not clogged. Check the installation of the external pump. Check the circulation pump. Check the flow sensor.
232	Problem in Water Flow sensor	<ul style="list-style-type: none"> Incorrect connection between sensor and main PCB of Indoor unit. PCB fault Sensor fault 	<ul style="list-style-type: none"> Display the flow rate value on the remote controller. Voltage : 1.22 V at 23 LPM (plugged) Refer voltage-pressure table to check in different flow rate.
231	Problem in Water Pressure sensor	<ul style="list-style-type: none"> Incorrect connection between sensor and main PCB of Indoor unit. PCB fault Sensor fault 	<ul style="list-style-type: none"> Display the water pressure value on the remote controller. Voltage : 0.65 V at 1.0 bar (plugged) Refer voltage-pressure table to check in different pressure.
15	Water pipe overheated	<ul style="list-style-type: none"> Abnormal operation of electric heater Leaving water temperature is above 57 °C(R410A)/65 °C(R32) 	<ul style="list-style-type: none"> If there is no problem in electric heater control, possible maximum leaving water temperature is 57 °C (R410A) / 65 °C(R32)
20	Thermal fuse is damaged	<ul style="list-style-type: none"> Thermal fuse is cut off by abnormal overheating of internal electric heater Mechanical fault at thermal fuse Wire is damaged 	<ul style="list-style-type: none"> This error will not be happened if temperature of electric heater tank is below 80 °C
21	DC PEAK (IPM Fault)	<ul style="list-style-type: none"> Instant over current Over Rated current Poor insulation of IPM 	<ul style="list-style-type: none"> An instant over current in the U,V,W phase <ul style="list-style-type: none"> Comp lock The abnormal connection of U,V,W Over load condition <ul style="list-style-type: none"> Overcharging of refrigerant Pipe length. Outdoor Fan is stop Poor insulation of compressor

Display code	Title	Cause of error	Check point & Normal condition
22	Max. C/T	Input Over Current	<ul style="list-style-type: none"> • Malfunction of Compressor • Blocking of Pipe • Low Voltage Input • Refrigerant, Pipe length, Blocked...
23	DC Link High / Low Volt	<ul style="list-style-type: none"> • DC Link Voltage is above 420 V DC • DC Link Voltage is below 140 V DC 	<ul style="list-style-type: none"> • Check CN_(L), CN_(N) Connection • Check Input Voltage • Check PCB DC Link voltage sensor parts
26	DC Compressor Position	<ul style="list-style-type: none"> • Compressor Starting fail error 	<ul style="list-style-type: none"> • Check the connection of comp wire "U,V,W" • Malfunction of compressor • Check the component of "IPM", detection parts.
27	AC Input Instant over Current Error	PCB(Inverter) input current is over 100 A(peak) for 2 us	<ul style="list-style-type: none"> • Overload operation (Pipe clogging/Covering/EEV defect/Ref. overcharge) • Compressor damage (Insulation damage/Motor damage) • Input voltage abnormal (L,N) • Power line assemble condition abnormal • PCB assembly 1 Damage (input current sensing part)
29	Inverter compressor over current	(HM**1M U*3) Inverter Compressor input current is 30 A. (HM**3M U*3) Inverter Compressor input current is 24 A.	<ul style="list-style-type: none"> • Overload operation (Pipe clogging/Covering/EEV defect/Ref. overcharge) • Compressor damage(Insulation damage/Motor damage) • Input voltage low • ODU PCB assembly 1 damage
32	High temperature in Discharge pipe of the inverter compressor	<ul style="list-style-type: none"> • Overload operation (Outdoor fan constraint, screened, blocked) • Refrigerant leakage (insufficient) • Poor INV Comp Discharge sensor • LEV connector displaced / poor LEV assembly 	<ul style="list-style-type: none"> • Check outdoor fan constraint/ screened/ flow structure • Check refrigerant leakage • Check if the sensor is normal • Check the status of EEV assembly
35	Low Presser Error	Excessive decrease of low pressure	<ul style="list-style-type: none"> • Defective low pressure sensor • Defective unit fan • Refrigerant shortage/leakage • Deformation because of damage of refrigerant pipe • Defective unit EEV • Covering / clogging (unit covering during the cooling mode / unit filter clogging during heating mode) • SVC valve clogging • Defective unit PCB(Inverter) • Defective unit pipe sensor
41	Problem in D-pipe temperature sensor	<ul style="list-style-type: none"> • Open / Short • Soldered poorly • Internal circuit error 	<ul style="list-style-type: none"> • Bad connection of thermistor connector • Defect of thermistor connector (Open/Short) • Defect of outdoor PCB(Inverter)
43	Problem in high pressure sensor	Abnormal value of sensor (Open/Short)	<ul style="list-style-type: none"> • Bad connection of connector PCB(Inverter) • Bad connection high pressure connector • Defect of high pressure connector (Open/Short) • Defect of connector PCB(Inverter) (Open/Short) • Defect of PCB(Inverter)

Display code	Title	Cause of error	Check point & Normal condition
44	Problem in outdoor air temperature sensor	<ul style="list-style-type: none"> • Open / Short • Soldered poorly • Internal circuit error 	<ul style="list-style-type: none"> • Bad connection of thermistor connector • Defect of thermistor connector (Open/Short) • Defect of outdoor PCB(Inverter)
45	Problem in Cond. middle pipe temperature sensor	<ul style="list-style-type: none"> • Open / Short • Soldered poorly • Internal circuit error 	<ul style="list-style-type: none"> • Bad connection of thermistor connector • Defect of thermistor connector (Open/Short) • Defect of outdoor PCB(Inverter)
46	Problem in suction pipe temperature sensor	<ul style="list-style-type: none"> • Open / Short • Soldered poorly • Internal circuit error 	<ul style="list-style-type: none"> • Bad connection of thermistor connector • Defect of thermistor connector (Open/Short) • Defect of outdoor PCB(Inverter)
52	PCB Communication Error	Checking the communication state between Main PCB and Inverter PCB	<ul style="list-style-type: none"> • Generation of noise source interfering with communication
54	Open and Reverse Phase Error	Prevention of phase unbalance and prevention of reverse rotation of constant-rate compressor	<ul style="list-style-type: none"> • Main power wiring fault
60	PCB(Inverter) & Main EEPROM check sum error	EEPROM Access error and Check SUM error	<ul style="list-style-type: none"> • EEPROM contact defect/wrong insertion • Different EEPROM Version • ODU Inverter & Main PCB assembly 1 damage
61	High temperature in Cond. Pipe	<ul style="list-style-type: none"> • Overload operation (Outdoor fan constraint, screened, blocked) • Unit heat exchanger contaminated • EEV connector displaced / poor EEV assembly • Poor Cond. Pipe sensor assembly / burned 	<ul style="list-style-type: none"> • Check outdoor fan constraint / screened / flow structure • Check if refrigerant overcharged • Check the status of EEV assembly • Check the status of sensor assembly / burn
62	Heat sink Temp. High error	Heat sink sensor detected high temp.(85 °C)	<ul style="list-style-type: none"> • Part no. : EBR37798101~09 <ul style="list-style-type: none"> - Check the heat sink sensor: 10 kΩ / at 25 °C(Unplugged) - Check the outdoor fan is driving rightly • Part no. : EBR37798112~21 <ul style="list-style-type: none"> - Check the soldered condition in the 22,23 pin of IPM, PFCM - Check the screw torque of IPM, PFCM - Check the spreadable condition of thermal grease on IPM, PFCM - Check the outdoor fan is driving rightly
65	Problem in heat sink Temperature sensor	Abnormal value of sensor(Open/Short)	<ul style="list-style-type: none"> • Check if there is defect of thermistor connector (Open/Short) • Check defect of outdoor PCB(Inverter)
67	Fan lock error	Fan RPM is less than 10 for 5 seconds from start-up operation. Fan RPM is less than 40 in operation except for start-up operation	<ul style="list-style-type: none"> • Fan motor damage. • Assembly condition abnormal. • Jammed fan by surroundings.
114	Problem in Vapor injection inlet temperature sensor	<ul style="list-style-type: none"> • Open (Below -48.7 °C)/ Short(Over 96.2 °C) • Soldered poorly • Internal circuit error 	<ul style="list-style-type: none"> • Bad connection of thermistor connector • Defect of thermistor connector (Open/Short) • Defect of outdoor PCB(Outdoor)



Eco design requirement

- The information for Eco design is available on the following free access website.
<https://www.lg.com/global/support/cedoc/cedoc>

[Representative] LG Electronics Inc. EU Representative : LG Electronics European Shared Service Center B.V. Krijgsman 1, 1186 DM Amstelveen, The Netherlands

[Manufacturer] LG Electronics Inc. Changwon 2nd factory 84, Wanam-ro, Seongsan-gu, Changwon-si, Gyeongsangnam-do, KOREA